

# Sterilizer

Model

**SN 200C/300C/500C  
/210C/310C/510C  
SQ 500C/800C/510C/810C**

## Instruction Manual

- Second Edition -

- Thank you for purchasing "Sterilizer, SN/SQ Series" of Yamato Scientific Co., Ltd.
- To use this unit properly, read this "Instruction Manual" thoroughly before using this unit. Keep this instruction manual around this unit for referring at anytime.



**WARNING!**

Carefully read and thoroughly understand the important warning items described in this manual before using this unit.

# Contents

◆ <b>Cautions in Using with Safety</b> .....	<b>1</b>
• Explanation.....	1
• Table of Illustrated Symbols .....	2
• Fundamental Matters of "WARNING!" and "CAUTION!" .....	3
◆ <b>Before Using This Unit</b> .....	<b>6</b>
• Requirements for Installation.....	6
• Installation Procedure.....	10
◆ <b>Description and Function of Each Part</b> .....	<b>16</b>
• Main Unit .....	16
• Inner structure .....	17
• Control Panel (Keys).....	18
• Control Panel (Indicators).....	19
• Control Panel (Operation monitoring lamp).....	20
• Characters of the Controller .....	21
• Operation Course/Function List.....	22
◆ <b>Operation Method</b> .....	<b>23</b>
• Operation Course/Function List.....	23
• Operation Course/Functional Setting Key and Character .....	25
• Apparatus/Liquid Sterilization Course .....	27
• Sterilization & Warm/Melting & Warm/Manual Course .....	29
• Maintenance Mode.....	31
• Forced Cooling Function / Preheating Function .....	34
• Memory Function.....	35
• Sample Temperature Function .....	37
• External Output Terminal (optional).....	39
◆ <b>Handling Precautions</b> .....	<b>41</b>
◆ <b>Maintenance Method</b> .....	<b>43</b>
• Daily Inspection and Maintenance .....	43
◆ <b>Long storage and disposal</b> .....	<b>44</b>
• When not using this unit for long term / When disposing .....	44
◆ <b>In the Event of Failure</b> ... ..	<b>45</b>
• Safety Device and Error Code.....	45
• Trouble Shooting .....	47
◆ <b>After Service and Warranty</b> .....	<b>48</b>
◆ <b>Specification</b> .....	<b>49</b>
◆ <b>Wiring Diagram</b> .....	<b>50</b>
• SN200C/300C/500C, SQ500C.....	50
◆ <b>Piping Diagram</b> .....	<b>52</b>
◆ <b>Replacement Parts Table</b> .....	<b>53</b>
◆ <b>Reference</b> .....	<b>56</b>
• List of Dangerous Substances .....	56
◆ <b>Installation Standard Manual</b> .....	<b>57</b>

## Explanation

### MEANING OF ILLUSTRATED SYMBOLS

#### Illustrated Symbols

Various symbols are used in this safety manual in order to use the unit without danger of injury and damage of the unit. A list of problems caused by ignoring the warnings and improper handling is divided as shown below. Be sure that you understand the warnings and cautions in this manual before operating the unit.

---

---

 **WARNING!** If the warning is ignored, there is the danger of a problem that may cause a serious accident or even fatality.

 **CAUTION!** If the caution is ignored, there is the danger of a problem that may cause injury/damage to property or the unit itself.

---

---

#### Meaning of Symbols



This symbol indicates items that urge the warning (including the caution). A detailed warning message is shown adjacent to the symbol.



This symbol indicates items that are strictly prohibited. A detailed message is shown adjacent to the symbol with specific actions not to perform.



This symbol indicates items that should be always performed. A detailed message with instructions is shown adjacent to the symbol.

# Cautions in Using with Safety

## Table of Illustrated Symbols

### Warning



Warning,  
generally



Warning,  
high voltage



Warning,  
high temperature



Warning,  
drive train



Warning,  
explosive

### Caution



Caution,  
generally



Caution,  
electrical shock



Caution,  
scald



Caution,  
no road heating



Caution,  
not to drench



Caution,  
water only



Caution,  
deadly poison

### Prohibit



Prohibit,  
generally



Prohibit,  
inflammable



Prohibit,  
to disassemble



Prohibit,  
to touch

### Compulsion



Compulsion,  
generally



Compulsion,  
connect to the  
grounding  
terminal



Compulsion,  
install on a flat  
surface



Compulsion,  
disconnect the  
power plug



Compulsion,  
periodical  
inspection

## Cautions in Using with Safety

### Fundamental Matters of "WARNING!" and "CAUTION!"

#### **WARNING!**

##### **Do not use this unit in an area where there is flammable or explosive gas**

Never use this unit in an area where there is flammable or explosive gas. This unit is not explosion-proof. An arc may be generated when the power switch is turned on or off, and fire/explosion may result.

##### **Always ground this unit**

Always ground this unit on the power equipment side in order to avoid electrical shock due to a power surge.

##### **If a problem occurs**

If smoke or strange odor should come out of this unit for some reason, turn off the circuit breaker right away, and then disconnect the power plug or power terminal. Immediately contact a service technician for inspection. If this procedure is not followed, fire or electrical shock may result. Never perform repair work yourself, since it is dangerous and not recommended.

##### **Do not use the power cord if it is bundled or tangled**

Do not use the power cord if it is bundled or tangled. If it is used in this manner, it can overheat and fire may be caused.

##### **Do not process, bend, wring, or stretch the power cord forcibly**

Do not process, bend, wring, or stretch the power cord forcibly. Fire or electrical shock may result.

##### **Substances that can not be used**

Never use explosive substances, flammable substances and substances that include explosive or flammable ingredients in this unit. Explosion or fire may occur.

##### **Do not disassemble or modify this unit**

Do not disassemble or modify this unit. Fire or electrical shock or failure may be caused.

##### **Do not get close to the vapor outlet / Do not block the outlet**

The vapor outlet is provided on the left face of equipment. Do not put your hands or face close to the outlet. Do not block the outlet. A burn injury or equipment failure may result in.

### Fundamental Matters of "WARNING!" and "CAUTION!"

#### **CAUTION!**

##### **When opening the cover...**

Make sure that the pressure of equipment has decreased to 0(zero) MPa before opening the cover. Generally the cover does not open due to the safety lock mechanism under the high pressure condition. The high-temperature and pressure vapor blows out if the cover is forced open under high pressure, which may cause a burn injury. A large amount of vapor blows out from inside of the chamber when opening the cover just after the sterilizing operation has completed (when the temperature inside the chamber is high). Do not put your hands and face close to the cover.

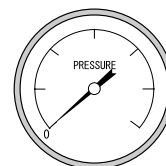

##### **When draining water...**

Make sure that the pressure of equipment has decreased to 0(zero) MPa before draining the sterilizing water. The hot water blows out if the valve is opened under high pressure. The sterilizing water remains very hot just after the sterilizing operation has completed even the pressure reading is 0(zero) MPa. Drain the water after it is sufficiently cooled down.

##### **Do not touch the drain bottle during operation**

A drain bottle, which contains hot water during and just after operation, is placed inside the door in the front face of equipment. To avoid a burn injury, remove the bottle after the water is sufficiently cooled down. Do not open the door during the operation of equipment.

##### **Make sure to drain the water when the water level comes to the seal position**

The hot water or vapor may blow out from the drain bottle if the equipment is operated with too much drain water (water level above the seal position). (Refer to 17 of "Precautions for continuous operation" in Page 13 for details.)

##### **Securely fix the silicon plug of the drain bottle**

Securely fix the silicon plug when installing the drain bottle. The hot water or vapor may blow out from the drain bottle if the equipment is operated with the plug loosen. (Refer to 6 of "Set the drain bottle" in Page 10 for details.)

##### **Pour off the water inside the vapor cup after every operation**

The cup becomes full with the water after the equipment is operated a few times. Pour off the water inside the cup after every operation. The hot water or vapor may blow out from the drain bottle if the cup is full with water. (Refer to 14 of "Attach the vapor cup" in Page 12 for details.)

##### **Do not touch the hot section**

Some sections on the equipment such as the circumference of cover or drain bottle are very hot during or just after the operation of equipment. Do not touch these sections to avoid burn injury.

## Cautions in Using with Safety

### Fundamental Matters of "WARNING!" and "CAUTION!"

#### **When taking the sterile samples from the chamber...**

Sufficiently remove the vapor inside the chamber before taking the sterile samples from the chamber. Wear heat-resistant leather gloves to take them from the chamber to protect your hands from high-temperature samples.

#### **Do not touch the heat releasing outlet**

Do not directly touch the heat releasing outlet located around the outer covering. The vapor may blow out from the safety valve by an accident during sterilizing operation. Do not block the outlet.

#### **During a thunder storm**

During a thunderstorm, turn off the power key immediately, then turn off the circuit breaker and the main power. If this procedure is not followed, fire or electrical shock may be caused.

#### **When power failure occurs...**

The lock lever on the cover goes into locked state for safety reasons when the power is turned off due to a power failure. The state is automatically cancelled when the power is turned on and the pressure inside the equipment decreases.

#### **Do not operate the equipment without supplying sufficient amount of water**

Do not operate the equipment without supplying sufficient amount of water. The heater is exposed to the open-air if the amount of water supplied is insufficient, which causes a deterioration or breakage of equipment. Make sure before operation that the appropriate amount of water is supplied inside the chamber. (Refer to 9 of "Pour water into the chamber" in Page 11 for details.)

#### **Do not open the panel on the outer covering**

Touching the interior portion of equipment may cause an electric shock, burn injury, fire disaster or equipment failure.

#### **Do not touch the power plug with a wet hand**

An electric shock may result in.

#### **Do not place your hand over the top board**

The hand may be stuck in the cover and injured.

## Requirements for Installation

### 1. Choose a proper place for installation



- Do not install this unit in a place where:
  - ◆ Rough or dirty surface.
  - ◆ Flammable gas or corrosive gas is generated.
  - ◆ Ambient temperature 35°C and above or 5°C and below.
  - ◆ Ambient temperature fluctuates violently.
  - ◆ There is direct sunlight.
  - ◆ There is excessive humidity and dust.
  - ◆ There is a constant vibration.
  - ◆ Not horizontal surface.
  - ◆ The power source is instable.



- Install this unit on a stable place with the space as shown below.

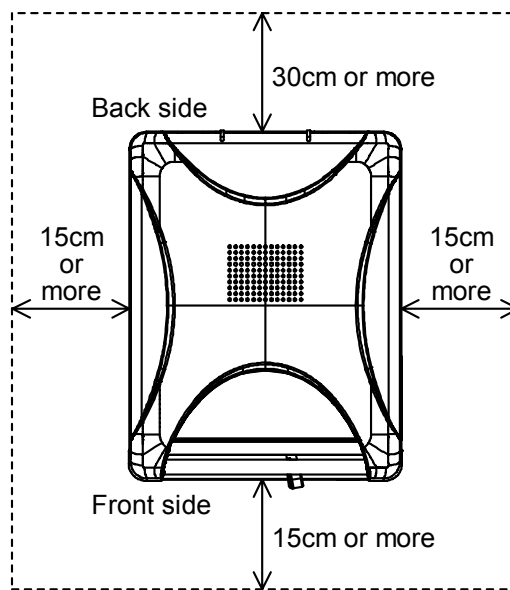

### 2. Installation on horizontal surface



- Use the equipment on the horizontal and firm place to keep the water inside the chamber horizontal. If the equipment tilts and the heater appears from the water surface, the temperature on the area above the water rises and a heater failure or operation stop due to water level detector function may occur.



- The weight of main unit is approximately 65 to 95kg. Carry and install the equipment carefully by two or more persons.

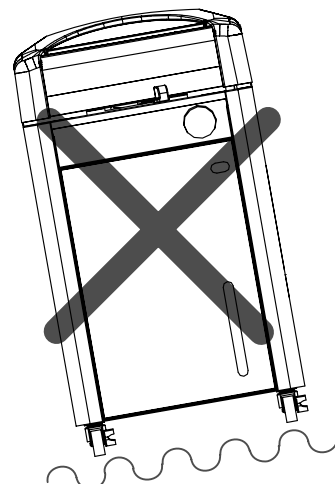



## Requirements for Installation

### 3. Before/after installing



- It may cause injury to a person if this unit falls down or moves by the earthquake and the impact. etc..To prevent, take measures that the unit cannot fall down, and not install to busy place.

### 4. Do not install the equipment near alarm device



- The equipment releases large amount of vapor when the cover is opened just after the operation is completed. Accordingly, do not install the equipment on the site over which electrical equipment especially an alarm device is provided over it.

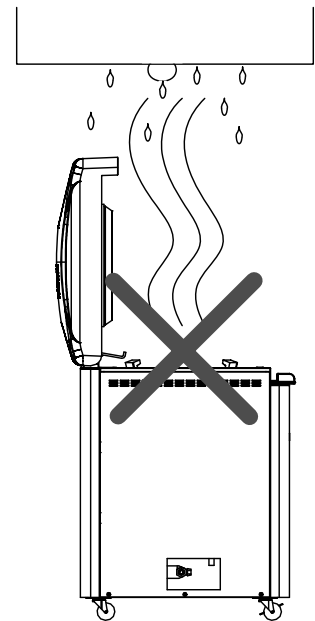

### 5. Ventilate the equipment sufficiently



- Do not block the heat releasing outlets on the side face and back face of equipment during operation. The temperature inside the equipment rises, which may cause the deterioration or failure of equipment, accident, or fire disaster.

### 6. Do not use this unit in an area where there is flammable or explosive gas



- Never use this unit in an area where there is flammable or explosive gas. This unit is not explosion-proof. An arc may be generated when the power switch is turned ON or OFF, and fire/explosion may result.
- To know about flammable or explosive gas, refer to page 56 “

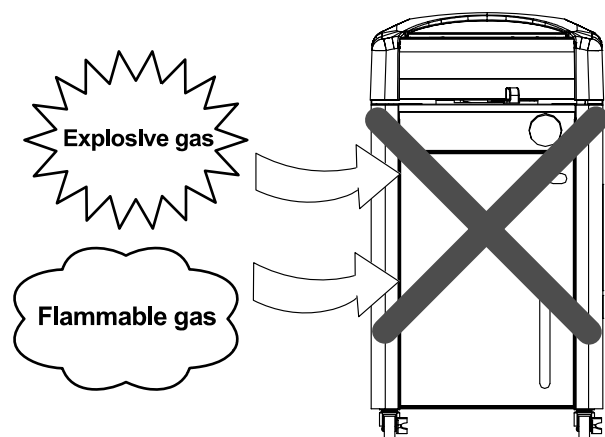

## Requirements for Installation

### 7. Choose a correct power distribution board or receptacle



- Choose a correct power distribution board or receptacle that meets the unit's rated electric capacity.
- Operating voltage range for respective equipment models are as follows.  
SN200C/300C/500C and SQ500C/800C models: AC100 to 120V  
SN210C/310C/510C and SQ510C/810C models: AC200 to 240V

**Electric capacity:** SN200C: AC100V-120V 12.5A-15.0A, SN210C: AC200V-240V 6.5A-7.5A  
SN300C: AC100V-120V 16.5A-20.0A, SN310C: AC200V-240V 8.5A-10A  
SN500C: AC100V-120V 19.5A-23.5A, SN510C: AC200V-240V 10.0A-12A  
SQ500C: AC100V-120V 20.5A-24.5A, SQ510C: AC200V-240V 10.5A-12.5A  
SQ800C: AC100V-120V 20.5A-24.5A, SQ810C: AC200V-240V 10.5A-12.5A

**NOTE)**

There could be the case that the unit does not run even after turning ON the power. Inspect whether the voltage of the main power is lowered than the specified value, or whether other device(s) uses the same power line of this unit. If the phenomena might be found, change the power line of this unit to the other power line.

- Starburst connection with a branching receptacle or extended wiring with a cord reel lowers electrical power voltage, which may cause the degradation of refrigeration capability.
- Connect the unit to only the power supply. If it is connected to a gas pipe, water pipe or telephone line, an accident or malfunction may result.

### 8. Handling of power code



- Do not entangle the power cord. This will cause overheating and possibly a fire.
- Do not bend or twist the power cord, or apply excessive tension to it. This may cause a fire and electrical shock.
- Do not lay the power cord under a desk or chair, and do not allow it to be pinched in order to prevent it from being damaged and to avoid a fire or electrical shock.
- Keep the power cord away from any heating equipment such as a room heater. The cord's insulation may melt and cause a fire or electrical shock.



- If the power cord becomes damaged (wiring exposed, breakage, etc.), immediately turn off the power at the rear of this unit and shut off the main supply power. Then contact your nearest dealer for replacement of the power cord. Leaving it may cause a fire or electrical shock.
- Connect the power plug to the receptacle which is supplied appropriate power and voltage.

## Requirements for Installation

### 9. Always ground this unit



- Be sure to connect the earth wire (the green cable of power cord) to the grounding conductor or ground terminal to prevent accidents caused by electric leakage.



- Do not connect the earth wire to gas or water pipes. If not, fire disaster may be caused.



- Do not connect the earth wire to the ground for telephone wire or lightning conductor. If not, fire disaster or electric shock may be caused.

- Please consult your local electrical contractor for power connecting work.

- Do not use a branching receptacle, which may cause the heat generation.

- The D class earth connecting works is required if no ground terminal is provided. In this case, consult with the selling office where you purchased or our sales office.

- Securely connect it to the switchboard or outlet.

SN210C/310C/510C, SQ510C/810C

SN200C/300C/500C, SQ500C/800C

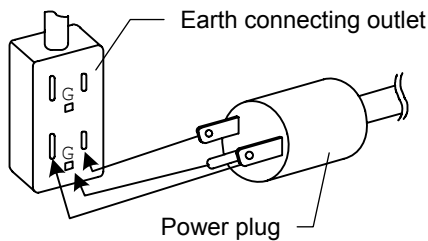

An earth connecting outlet is recommended to be used.

Rounded terminal for M4

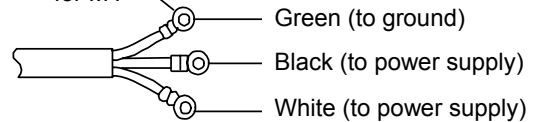

These models do not include the power plug. Correctly connect the ground to fit with the power supply facility to be connected.



### 10. Connect the power cord paying attention to the color of each core wire



- When connecting the power cord, do check the breaker on the electric power equipment be "OFF". Note that SN210C/300C/310C/500C/510C and SQ500C/510C do not equip with the power plug. Select and connect the appropriate plug or terminal corresponding to the power capacity that is adjusted to the status of the power supply equipment side.

Core Wire Color	Interior Wiring
Black	Power Supply Side
White	Power Supply Side
Yellow And Green	Ground Wire Side

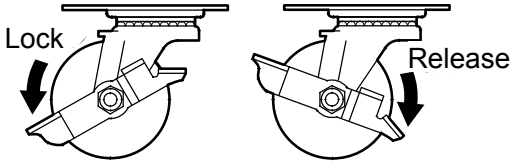
## Installation Procedure

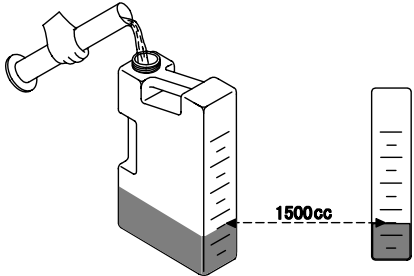
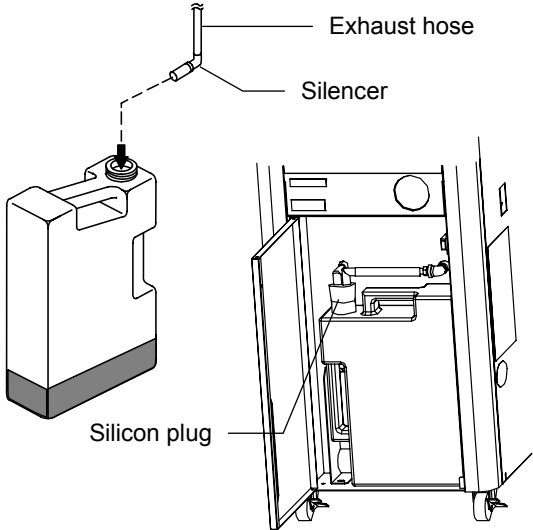
<b>1</b>	<b>Determine the installation site</b>	<ul style="list-style-type: none"> <li>If there is a bump on the floor, the casters may receive excessive load and get damaged. In this case, lift and move carefully by two or more persons. Install the equipment referring to 1 to 5 of "Requirements for Installation" in Page 6.</li> </ul>
<b>2</b>	<b>After the unit is placed in the desired position, lock the stopper button of the casters</b>	<ul style="list-style-type: none"> <li>Only the two casters on the front side of the unit are equipped with a stopper.</li> </ul> <div style="text-align: right;">  </div>
<b>3</b>	<b>Connecting the power</b>	<ul style="list-style-type: none"> <li>Connect the power referring to 7 to 10 of "Requirements for Installation" in Page 6.</li> </ul>
<b>4</b>	<b>Open the cover</b>	<ul style="list-style-type: none"> <li>Turn on the electric leakage breaker at the right side of equipment and turn on the power to open the cover. The safety lock is released and the cover can be opened.</li> <li>Slide the lock lever on the cover to the right and grasp the handle of cover to open it.</li> </ul> <div style="text-align: right;"> <p>Turn the lock lever to the left to close the cover. Turn the lock lever to the right to open the cover.</p>  </div>
<b>5</b>	<b>Pour water into the drain bottle</b>	<ul style="list-style-type: none"> <li>Pour 1500cc of water into the drain bottle. The water is used to cool down the high-temperature vapor generated inside the chamber.</li> </ul> <div style="text-align: right;">  </div>
<b>6</b>	<b>Set the drain bottle</b>	<ul style="list-style-type: none"> <li>During operation, high-temperature vapor blows out from the equipment. Make sure to set the drain bottle. If the bottle is not set, the safety device (micro switch) functions to prevent the equipment from operating.</li> </ul> <ol style="list-style-type: none"> <li>① Open the door in the front face of equipment.</li> <li>② Put the exhaust hose silencer into the drain bottle which contains 1500cc of water in it.</li> <li>③ Set the bottle to the inside of door. Insert the exhaust hose into the bottle and fix the silicon plug onto the opening of bottle.</li> <li>④ The micro switch is pressed and the equipment is ready to operate. The temperature display screen and time display screen are displayed.</li> </ol> <div style="text-align: right;">  </div>

## Installation Procedure

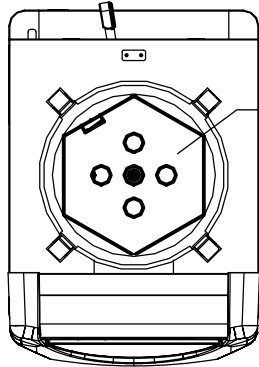
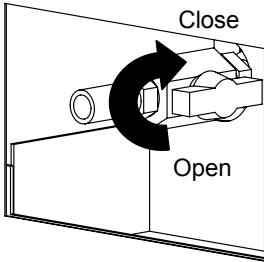
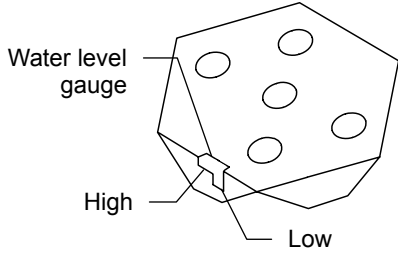
7	<p><b>Set the attached drain board onto the bottom surface inside the chamber</b></p> <ul style="list-style-type: none"> <li>The drain board stabilizes the sterile samples inside the chamber as well as protects the heater and sensor. Make sure to set it.</li> </ul>	 <p style="text-align: right;">Set the drain board horizontally.</p>												
8	<p><b>Close the drain valve</b></p> <ul style="list-style-type: none"> <li>Close the drain valve at the bottom on the left side face of main unit. Water leak occurs if not fully closed, which may cause the burn injury or no-load (water) operation.</li> <li>Connect an appropriate hose (inner diameter: 12mm) to the drain valve and lead it to the draining site.</li> </ul>													
9	<p><b>Pour water into the chamber</b></p> <ul style="list-style-type: none"> <li>Before setting the sterile samples, pour water into the chamber to the water level gauge (notch) position.</li> <li>Insufficient water may cause the no-load (water) operation. Check the water level every time before operation. Refill it before the level becomes too low. Water is required to be poured at dissolution operation, as well as sterilizing operation.</li> <li>When the water level lowers, the equipment detects an abnormality ("Err20") and cuts off the heater. Depending on the conditions of equipment, however, the detection requires too much time, which may cause the heater deterioration. Refill water before the water level becomes too low.</li> <li>Refer to the right table for the quantity of water to be refilled.</li> </ul>	 <table border="1" style="margin-left: auto; margin-right: auto;"> <thead> <tr> <th colspan="2">Water QTY for models</th> </tr> </thead> <tbody> <tr> <td>SN200C/210C</td> <td>2200~2300 cc</td> </tr> <tr> <td>SN300C/310C</td> <td>3500~3700 cc</td> </tr> <tr> <td>SN500C/510C</td> <td>3500~3700 cc</td> </tr> <tr> <td>SQ500C/510C</td> <td>6300~6500 cc</td> </tr> <tr> <td>SQ800C/810C</td> <td>6300~6500 cc</td> </tr> </tbody> </table>	Water QTY for models		SN200C/210C	2200~2300 cc	SN300C/310C	3500~3700 cc	SN500C/510C	3500~3700 cc	SQ500C/510C	6300~6500 cc	SQ800C/810C	6300~6500 cc
Water QTY for models														
SN200C/210C	2200~2300 cc													
SN300C/310C	3500~3700 cc													
SN500C/510C	3500~3700 cc													
SQ500C/510C	6300~6500 cc													
SQ800C/810C	6300~6500 cc													
10	<p><b>Use distilled or purified water for sterilizing water</b></p> <ul style="list-style-type: none"> <li>Fill distilled or purified water inside the chamber. Tap water may be used. Calculus generate inside the chamber when tap water is used. Frequent cleaning is therefore required.</li> <li>Do not use well water. It may cause the corrosion or dirt inside the chamber.</li> </ul>													

## Installation Procedure

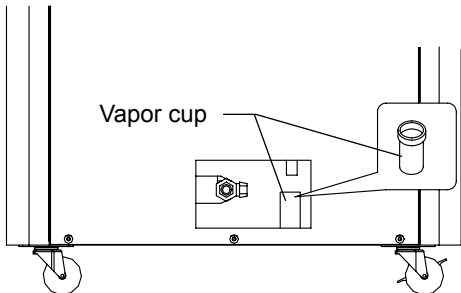
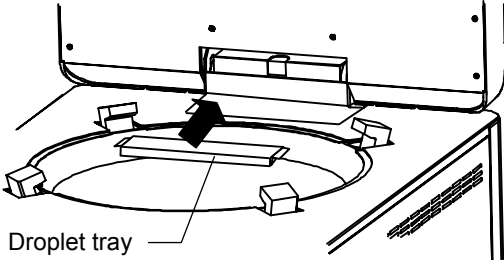
11	<p><b>Set the sterile samples</b></p> <ul style="list-style-type: none"> <li>• Set the samples to the chamber, putting them into the attached rack or cast (sold separately).</li> <li>• Put the sample or sterilization bag into the chamber so they should not block or cover the sensor inside the chamber, exhaust outlet and end connection to pressure gauge. If they are blocked or covered, the vapor cannot be discharged and the equipment cannot be operated correctly. Do not spill the samples when taking them out from/putting them into the chamber. The failure in piping system, bad smell or dirt may result in.</li> <li>• In case liquid such as medicinal solution or medium is sterilized, the amount of liquid should be 60% or less of the capacity of container. They may be boiled over if too much quantity is supplied.</li> <li>• Widely open the opening of sterilization bag when used. If it is closed, the samples are insufficiently sterilized.</li> </ul>
12	<p><b>Close the door before operation</b></p> <ul style="list-style-type: none"> <li>• Make sure to close the door of equipment before operation. If the door is not fully closed, the drain bottle falls down and may cause a burn injury. Do not open the door during operation.</li> </ul>
13	<p><b>Close the cover</b></p> <ul style="list-style-type: none"> <li>• Make sure that no foreign objects exist on the packing of the cover and its contact area before closing the cover. If any foreign object exists, the vapor may leak from the inside.</li> <li>• The lock lever on the cover is held by the hook and does not move when the cover remains open.</li> <li>• Fully close the cover and slide the lock lever on the cover to the left side. If it is closed inappropriately, the vapor blows out from the inside, which may cause a burn injury.</li> <li>• Do not press the hook and operate the lock lever for purposes other than maintenance of equipment.</li> </ul> <div style="text-align: right; margin-right: 50px;"> <p>Turn the lock lever to the left to close the cover. Turn the lock lever to the right to open the cover.</p>  </div>
14	<p><b>Attach the vapor cup</b></p> <ul style="list-style-type: none"> <li>• The equipment is equipped with a vapor cup to prevent the vapor that generate during air purge from becoming water droplet and dropping down onto the floor. Attach the cup onto the vapor outlet on the left side face of equipment referring to the right figure. Make sure to pour off the water inside the vapor cup after every operation.</li> </ul> <div style="text-align: right;">  </div>
15	<p><b>Attach the droplet tray</b></p> <ul style="list-style-type: none"> <li>• Attach the droplet tray to the equipment to prevent the water drops that are made from vapor that generate during air purge from dropping down from the packing onto the samples or onto the top board. Pour off the droplets inside the tray periodically.</li> </ul> <div style="text-align: right;">  </div>

## Installation Procedure

16	<b>Precautions for drainage</b> <ul style="list-style-type: none"><li>• Before draining the water, make sure that the pressure, equipment temperature and water temperature inside the chamber have decreased sufficiently.</li></ul>
17	<b>Precautions for continuous operation</b> <ul style="list-style-type: none"><li>• When operating the equipment continuously after sterilization is completed, leave the equipment for about 15 minutes with the cover opened to sufficiently lower the temperature inside the chamber and then close the cover. If the temperature is high, the cover may not close due to high internal pressure of chamber.</li><li>• Before operating the equipment again, check the water level of drain bottle by observing it from the observation window to make sure that it is below the level indicated by the drain level seal on the door. In case the water level of drain bottle is above the drain level seal, drain the water until the water level comes to 1500cc of the water level gauge, indicated on the side face of bottle. The hot water or vapor may blow out from the drain bottle if the equipment is operated with too much drain water (above the seal position).</li></ul>

## Installation Procedure

### Reference Data

#### Sterilizing operation using disposal bag for biochemical dangerous object

- ① Open the opening of sterilization bag so the vapor can be easily entered into it. Secure the bag with a wire rack so it should not fall down during operation.
- ② The height of bag should be about two-thirds of chamber. If it is too high, the vapor cannot be easily entered into it, or it blocks the vapor outlet at the upper part of chamber, which may cause insufficient sterilization.
- ③ The preset temperature should be the upper temperature limit of bag to be used.
- ④ The preset time varies depending on the quality and quantity of sterile samples. Refer to the following data for the preset time.



- Reference example of SN500 model at room temperature of 25°C

Sterile sample	Sterilization temperature	Sterilization time	Note
Gauze	121°C	30 min.	Five bolts of dry gauze
Petri dish	121°C	40 min.	30 Petri dish with a cover

- ❖ The data above, however, is used as reference. The actual sterile condition varies depending on the characteristics and quantity of samples or type of vessels to be used. Confirm the sterile condition using the biological indicator or chemical indicator.



## Installation Procedure

### Time lag

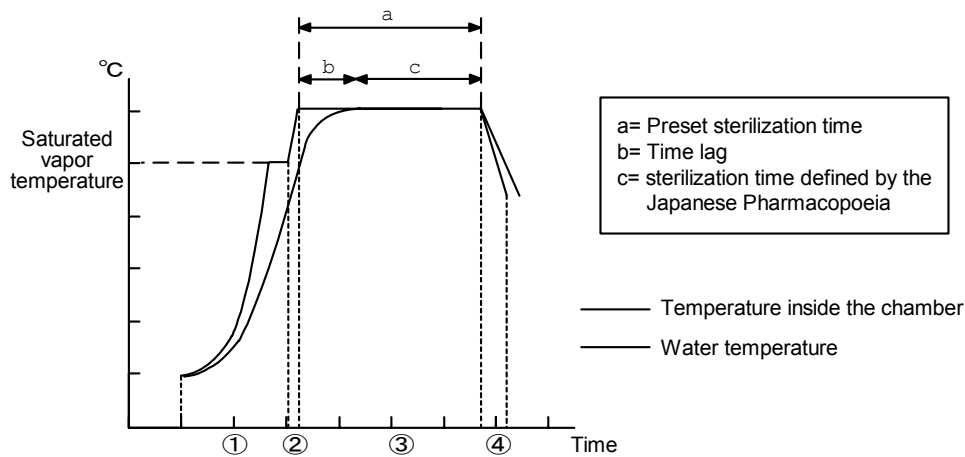

When sterilizing liquid samples, a time lag (b) is made between the temperature inside the chamber and actual temperature of liquid by the time when the liquid temperature reaches the preset sterilization temperature. For this reason, a longer time than defined by the Japanese Pharmacopoeia (c) is required to completely sterilize the samples. Consequently, the actual preset sterilization time (a) should be set to be extended. The right table shows the time lag between the temperature inside the chamber and actual temperature of liquid (water). The table below shows the temperature rise and cooling time with no load (liquid).

Preset sterilization temperature: 121°C/room temperature: 25°C (using conical flask)

Load	Time lag	
	SN200C/210C /300C/310C	SN500C/510C SQ500C/510C
500cc	20min.	20min.
1000cc	20min.	20min.
2000cc	25min.	25min.
3000cc	25min.	25min.
4000cc	25min.	25min.
5000cc	30min.	30min.

### Necessary time for sterilization

At room temperature of 25°C (Course: apparatus sterilization/forced cooling: OFF)

Model	Water temperature	Sterilization conditions		Time required			Total time required ①+②+③+④
		Preset temperature	Preset time ③	Air purge time ①	Pressurizing time ②	Cooling-down time ④	
SN200C/210C	25°C	121°C	20min.	23min.	16min.	29min.	88min.
	25°C	126°C	15min.	23min.	20min.	33min.	91min.
SN300C/310C	25°C	121°C	20min.	25min.	20min.	31min.	96min.
	25°C	126°C	15min.	25min.	22min.	35min.	97min.
SN500C/510C	25°C	121°C	20min.	25min.	20min.	33min.	98min.
	25°C	126°C	15min.	25min.	22min.	37min.	99min.
SQ500C/510C	25°C	121°C	20min.	30min.	20min.	36min.	106min.
	25°C	126°C	15min.	31min.	24min.	40min.	110min.
SQ800C/810C	25°C	121°C	20min.	33min.	22min.	40min.	115min.
	25°C	126°C	15min.	35min.	25min.	45min.	120min.

# Description and Function of Each Part

## Main Unit

### Front/upper view

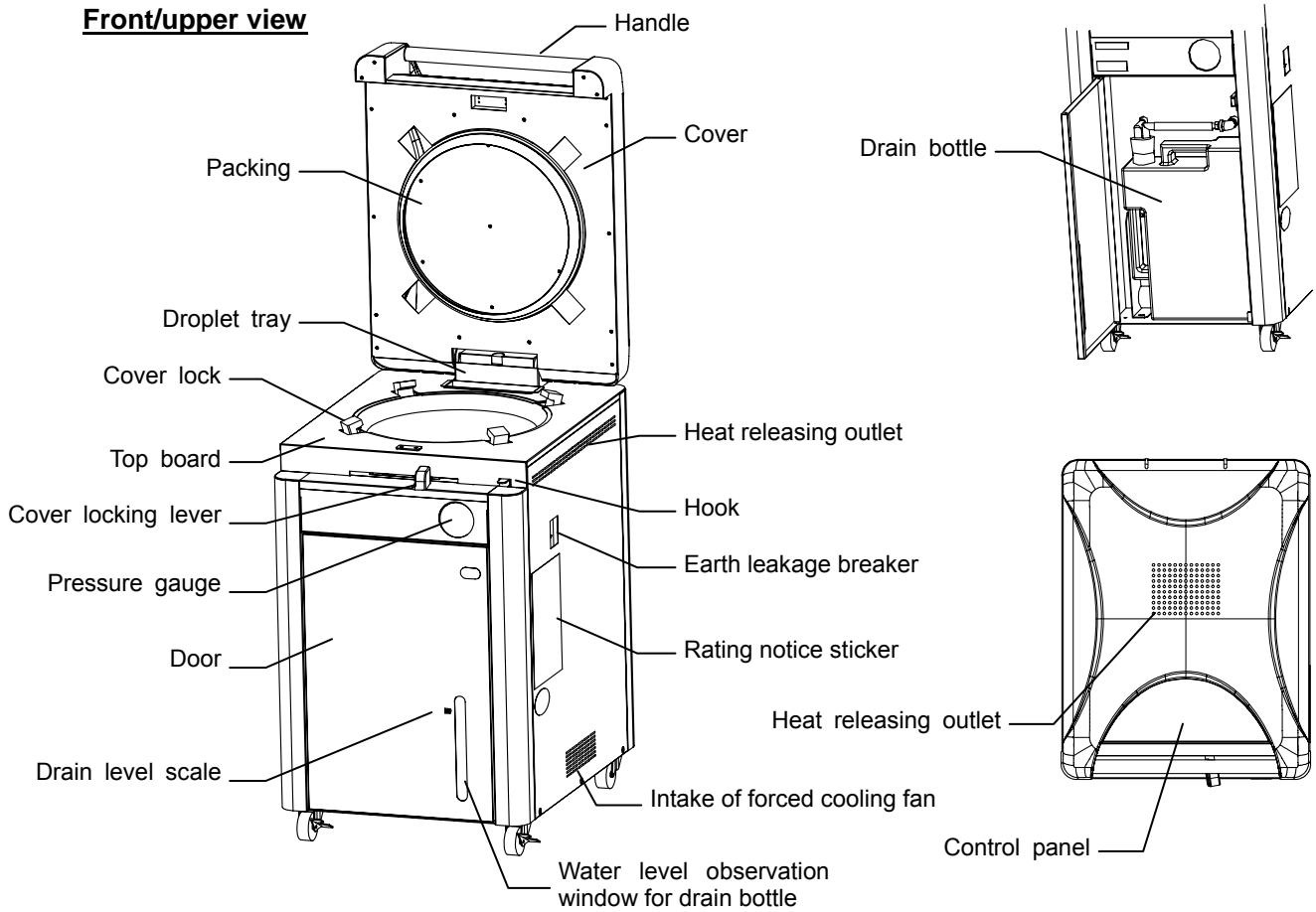

### Rear view

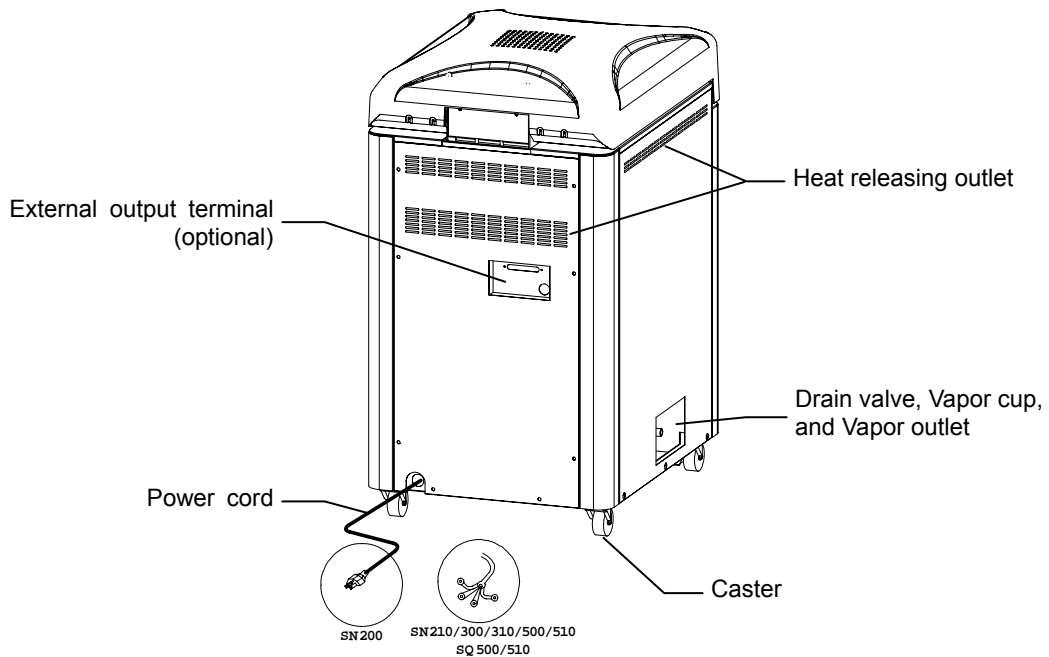

# Description and Function of Each Part

## Inner structure

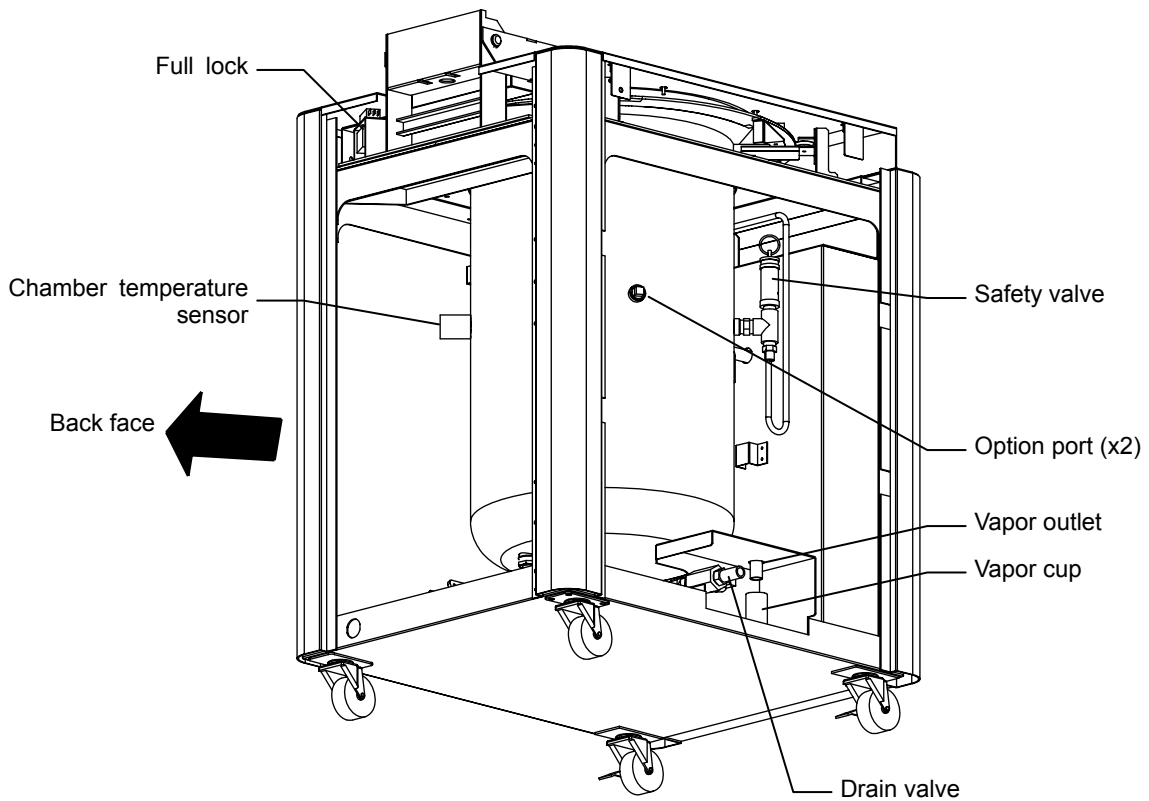
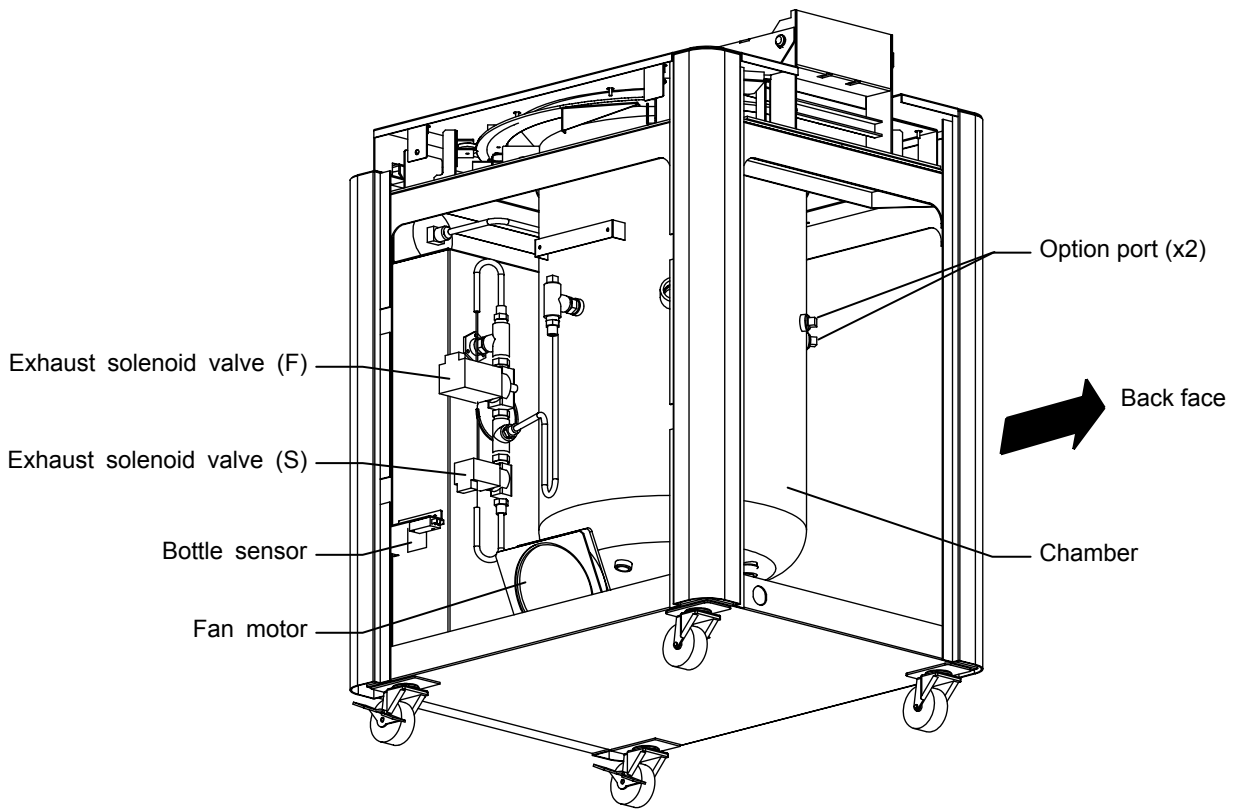

# Description and Function of Each Part

## Control Panel (Keys)

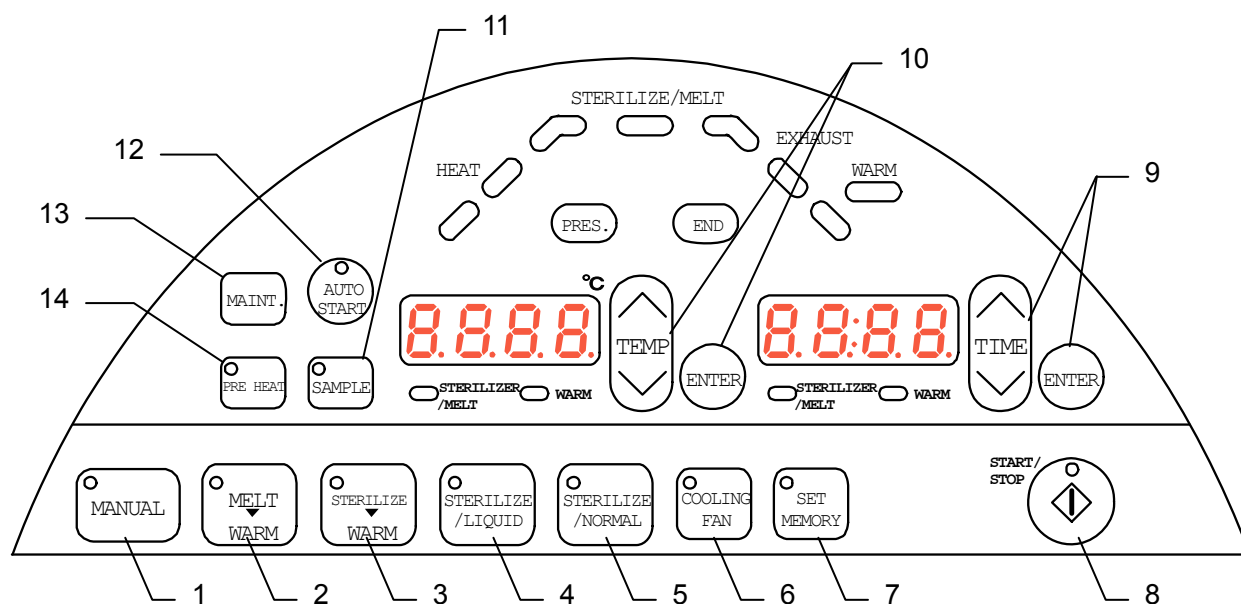

No.	Name	Function
1	Manual course key (MANUAL)	This key is used to select manual course.
2	Melting & Warm course key (MELT→WARM)	This key is used to select melting & warm course.
3	Sterilization & Warm course key (STERILIZE→WARM)	This key is used to select sterilization & warm course.
4	Liquid sterilization course key (STERILIZE/LIQUID)	This key is used to select liquid sterilization course.
5	Apparatus sterilization course key (STERILIZE/NORMAL)	This key is used to select apparatus sterilization course.
6	Forced cooling key (COOLING FAN)	This key is used to set/cancel the forced cooling.
7	MEMORY (SET MEMORY)	This key is used to read/register the memory.
8	Start/stop key (START/STOP)	This key is used to start/stop operation.
9	Time setting key (TIME)	This key is used to set the time parameter.
10	Temperature setting key (TEMP)	This key is used to set the temperature parameter.
11	Sample temperature key (SAMPLE)	This key is used to set/cancel the optional sample temperature sensor (sold separately).
12	Auto start key (AUTO START)	This key is used to perform auto start operation. Press it after selecting the course.
13	Maintenance key (MAINT.)	This key is used for maintenance settings.
14	Preheating key (PRE HEAT)	This key is used to set the preheating operation.

# Description and Function of Each Part

## Control Panel (Indicators)

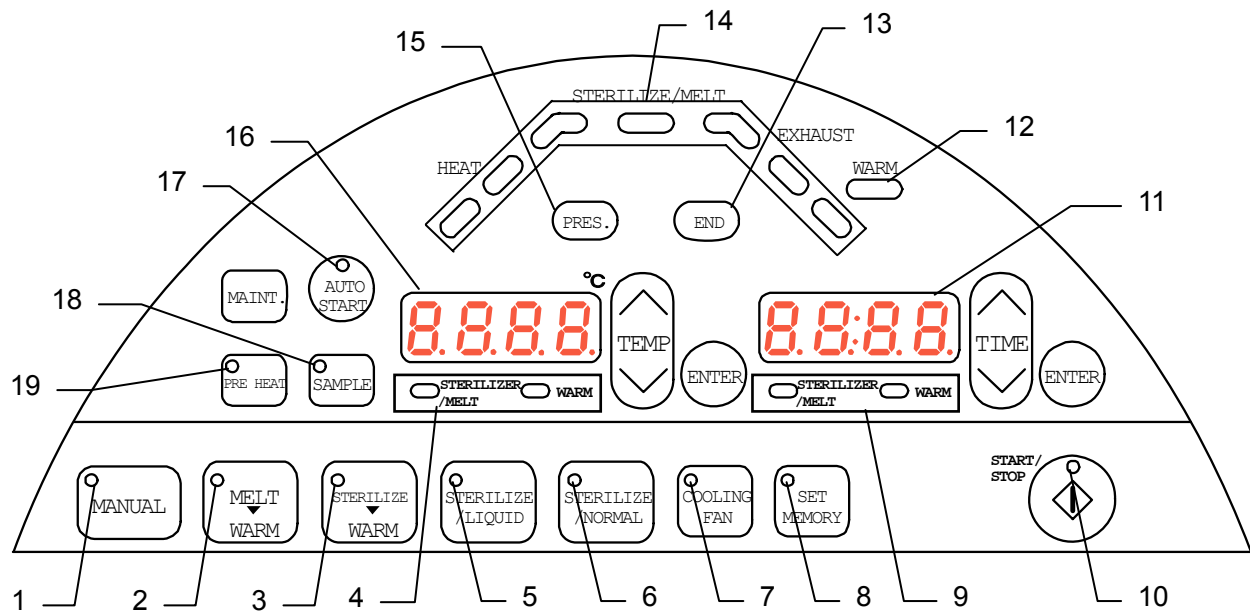

No.	Name	Function
1	Manual course lamp (MANUAL)	This lamp lights up when manual course is selected.
2	Melting & Warm course lamp (MELT→WARM)	This lamp lights up when melting & warm course is selected.
3	Sterilization & Warm course lamp (STERILIZE→WARM)	This lamp lights up when sterilization & warm course is selected.
4	Sterilization/melting & warm (STERILIZER/MELT, WARM) temperature lamp	This lamp blinks at temperature setting of sterilization/melting & warm.
5	Liquid sterilization course lamp (STERILIZE/LIQUID)	This lamp lights up when liquid sterilization course is selected.
6	Apparatus sterilization course lamp (STERILIZE/NORMAL)	This lamp lights up when apparatus sterilization course is selected.
7	Forced cooling lamp (COOLING FAN)	This lamp lights up when forced cooling process is selected.
8	MEMORY lamp (SET MEMORY)	This lamp lights up at the setting of memory.
9	Sterilization/melting & warm (STERILIZER/MELT, WARM) time lamp	This lamp blinks at the setting of time for sterilization/melting & warm
10	Start/stop lamp (START/STOP)	This lamp lights up during operation and goes out at operation stop.
11	Time display screen	The display blinks at the setting of time parameters. It displays the remaining time during operation of equipment.
12	Heat-retention lamp (WARM)	This lamp blinks at the setting of heat-retention process.
13	End lamp (END)	This lamp blinks when operation is completed.
14	Operation monitoring lamp	Refer to Page 20.
15	Pressurization lamp (PRES.)	This lamp lights up when the equipment is being pressurized.
16	Temperature display screen	The display blinks at the setting of temperature parameters. It displays the temperature inside the chamber during operation of equipment.
17	Auto start lamp (AUTO START)	This lamp lights up when auto start key is pressed. It blinks after the auto start time is set.
18	Sample temperature lamp (SAMPLE)	This lamp lights up when the sample temperature key (SAMPLE) is selected when optional sample temperature sensor, which is sold separately, is attached.
19	Preheating lamp (PRE HEAT)	This lamp lights up when the preheating key (PRE HEAT) is selected. It blinks during the preheating operation.

# Description and Function of Each Part

## Control Panel (Operation monitoring lamp)

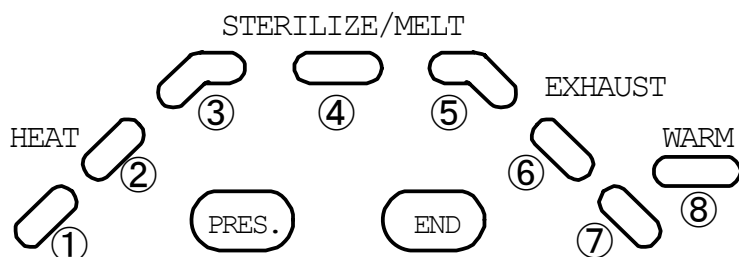

No.	Name
① · ②	Heat lamp (HEAT)
③ · ④ · ⑤	Sterilization/melting lamp (STERILIZE/MELT)
⑥ · ⑦	Exhaust lamp (EXHAUST)
⑧	Heat-retention lamp (WARM)

The current operating state of equipment can be checked by observing the status of respective lamp.













Operating state	Lamp state									During pressurization	End
	①	②	③	④	⑤	⑥	⑦	⑧			
Stop	OFF	OFF	OFF	OFF	OFF	OFF	OFF	OFF	OFF	OFF	OFF
During preheating	Blink	OFF	OFF	OFF	OFF	OFF	OFF	OFF	OFF	OFF	OFF
Before pressurization/during temperature rising	Blink	OFF	OFF	OFF	OFF	OFF	OFF	OFF	OFF	OFF	OFF
During pressurization/during temperature rising	ON	Blink	OFF	OFF	OFF	OFF	OFF	OFF	OFF	ON	OFF
When sterilization/melting starts	ON	ON	Blink	OFF	OFF	OFF	OFF	OFF	OFF	ON	OFF
After one-thirds of sterilization/melting process is completed	ON	ON	ON	Blink	OFF	OFF	OFF	OFF	OFF	ON	OFF
After two-thirds of sterilization/melting process is completed	ON	ON	ON	ON	Blink	OFF	OFF	OFF	OFF	ON	OFF
When exhaust process starts	ON	ON	ON	ON	ON	Blink	OFF	OFF	OFF	OFF	OFF
When measured temperature lowers to the saturated vapor temperature without heat-retention process	ON	ON	ON	ON	ON	ON	Blink	OFF	OFF	OFF	OFF
When sterilization/melting is completed without heat-retention process	ON	OFF	OFF	OFF	OFF	OFF	OFF	OFF	OFF	OFF	Blink
During heat-retention	ON	ON	ON	ON	ON	ON	OFF	Blink	OFF	OFF	OFF
When heat-retention process is completed	ON	OFF	OFF	OFF	OFF	OFF	ON	ON	OFF	OFF	Blink

※ When operation is stopped during pressurization/sterilization by the START/STOP key or a power failure, the lamps ③, ④ and ⑤ light off.

## Description and Function of Each Part

### Characters of the Controller

The characters controller shows are as follows:

Character	Identifier	Name	Purpose
	<b>yEARr</b>	Calendar (year) setting	Used to set calendar (year).
	<b>MntH</b>	Calendar (month) setting	Used to set calendar (month).
	<b>_dAY</b>	Calendar (day) setting	Used to set calendar (day).
	<b>timE</b>	Time setting	Used to set the time.
	<b>_Loc</b>	Key lock	Locks the key to disable the change of preset value.
	<b>PLoc</b>	Pattern lock	Locks the key to disable the change of memory.
	<b>_bUZ</b>	Buzzer sound setting	Used to set the buzzer sound.
	<b>_Err</b>	Error log	Used to check the error log.
	<b>Accm</b>	Accumulated time	Used to check the accumulated time.
	<b>SmPL</b>	Sample temperature sensor for sample	Used to check the sample temperature sensor (optional accessory).
	<b>PrEH</b>	Preheating temperature	Used to set the preheating temperature.
	<b>End</b>	Operation end	Displayed when operation is completed.
	<b>bLAc oUt</b>	Reparation at power failure	Displayed when power is restored during operation.

※ Refer to “Operation Course/Functional Setting Key and Character” in Page 25 for the operation courses and functional characters.

## Operation Course/Function List

The equipment can carry out the following operation courses.

Name	Description	Page
Apparatus sterilization course	This course sterilizes apparatus made of metal, glass, rubber and ceramics.	27
	<ul style="list-style-type: none"> <li>• Press the STERILIZE/NORMAL key to go into the operation setting mode.</li> <li>• If other course has been selected, press the STERILIZE/NORMAL key again.</li> <li>• Set the temperature with the TEMP key and then press the ENTER key.</li> <li>• Set the time with the TIME key and then press the ENTER key.</li> <li>• Press the START/STOP key to start operation.</li> <li>• Press the START/STOP key again to stop operation.</li> </ul>	
Liquid sterilization course	This course sterilizes liquid such as water, medium, test solution and test reagent.	27
	<ul style="list-style-type: none"> <li>• Press the STERILIZE/LIQUID key to go into the operation setting mode.</li> <li>• If other course has been selected, press the STERILIZE/LIQUID key again.</li> <li>• Set the temperature with the TEMP key and then press the ENTER key.</li> <li>• Set the time with the TIME key and then press the ENTER key.</li> <li>• Press the START/STOP key to start operation.</li> <li>• Press the START/STOP key again to stop operation.</li> </ul>	
Sterilization & Warm course	This course sterilizes medium and then keeps them warm.	29
	<ul style="list-style-type: none"> <li>• Press the STERILIZE→WARM key to go into the operation setting mode.</li> <li>• If other course has been selected, press the STERILIZE→WARM key again.</li> <li>• Set the sterilization time and sterilization temperature.</li> <li>• Set the temperature with the TEMP key and then press the ENTER key.</li> <li>• Set the time with the TIME key and then press the ENTER key.</li> <li>• Set the heat-retention time and heat-retention temperature.</li> <li>• Set the temperature with the TEMP key and then press the ENTER key.</li> <li>• Set the time with the TIME key and then press the ENTER key.</li> <li>• Press the START/STOP key to start operation.</li> <li>• Press the START/STOP key again to stop operation.</li> </ul>	
Melting & Warm course	This course melts medium and then keeps them warm.	29
	<ul style="list-style-type: none"> <li>• Press the MELT→WARM key to go into the operation setting mode.</li> <li>• If other course has been selected, press the MELT→WARM key again.</li> <li>• Set the melting time and sterilization temperature.</li> <li>• Set the temperature with the TEMP key and then press the ENTER key.</li> <li>• Set the time with the TIME key and then press the ENTER key.</li> <li>• Set the heat-retention time and heat-retention temperature.</li> <li>• Set the temperature with the TEMP key and then press the ENTER key.</li> <li>• Set the time with the TIME key and then press the ENTER key.</li> <li>• Press the START/STOP key to start operation.</li> <li>• Press the START/STOP key again to stop operation.</li> </ul>	



## Operation Course/Function List

Name	Description	Page
Manual course	This course sterilizes and warms other samples other than the above.	29
	<ul style="list-style-type: none"> <li>• Press the MANUAL key to go into the operation setting mode.If other course has been selected, press the MANUAL key again.</li> <li>• Set the sterilization time and sterilization temperature.</li> <li>• Set the temperature with the TEMP key and then press the ENTER key.</li> <li>• Set the time with the TIME key and then press the ENTER key.</li> <li>• Set the heat-retention time and heat-retention temperature.</li> <li>• Set the temperature with the TEMP key and then press the ENTER key.</li> <li>• Set the time with the TIME key and then press the ENTER key.</li> <li>• Press the START/STOP key to start operation.</li> <li>• Press the START/STOP key again to stop operation.</li> </ul>	
❖ The current operation mode can not be changed during operation of equipment. To change the operation mode, stop the operation of equipment.		

The equipment has the following functions.

Name	Description	Page
Calendar setting	This function is included in the maintenance mode. It sets the dominical year, month, date and time.	31
Key lock function	This function is included in the maintenance mode. It disables all key operations, except the START/STOP key operation and cancellation of Key lock state. The “_Loc” is displayed if an unavailable key operation is done. (※)	
Pattern lock function	This function is included in the maintenance mode. It disables the change related to operation course and memory. The “PLoc” is displayed if an unavailable key operation is done. (※)	
Buzzer function	This function is included in the maintenance mode. It mutes the key operation sound except for the buzzer sounds at warning and operation end.	
Error log display	This function is included in the maintenance mode. It displays up to 20 errors occurred in the past, including the error content and time of occurrence.	
Setting of sample temperature sensor	This function is included in the maintenance mode. It enables the sample temperature function. If the setting is turned to ON when the optional sample sensor is not attached, the “Er.8”, which indicates disconnection of sample sensor, occurs.	
Accumulated time	This function is included in the maintenance mode. It displays the accumulated current-carrying time by the hour.	
※: When both of Key lock and pattern lock functions have been set, “_Loc” is displayed by priority.		

## Operation Course/Function List

The operation functions of this unit are as follows;

Name	Description	Page
Forced cooling function	<p>This function turns on the cooling fan during exhaust process to shorten the cooling time.</p> <p>The cooling fan is turned on during switching to the exhaust process in the apparatus sterilization course. In other courses, it starts to run at the saturated vapor temperature of -2°C or less. It stops when the equipment goes into the standby state after operation is completed, or when the temperature inside the chamber reaches 60°C.</p> <p>The COOLING FAN key can be set anytime before and during operation of equipment.</p> <p>Pressing the COOLING FAN key lights the COOLING FAN lamp and makes the function available.</p>	34
Preheating function	<p>This function keeps the temperature of feed water inside the chamber with the preset temperature.</p> <p>The range of preset temperature is from 45°C to 80°C. The operation automatically ends after five hours.</p> <p>Pressing the PRE HEAT key lights the PRE HEAT lamp. The preset temperature is displayed with blinking. Set the desired value and then press the ENTER key. This enables the function.</p>	
Memory function	<p>Each operation course has three memory banks, where registration and read of settings are possible. The following settings can be stored into the memory.</p> <ul style="list-style-type: none"> <li>• Sterilization (melting) temperature</li> <li>• Sterilization (melting) time</li> <li>• Heat-retention temperature</li> <li>• Heat-retention time</li> <li>• ON/OFF of forced cooling function</li> </ul>	35
Auto start function	<p>This function automatically starts the operation of equipment at the specified time with the selected course.</p> <p>The time can be set in increments of one minute within the range from 00 : 00 to 23 : 59.</p>	36
Sample temperature function (optional)	<p>This function counts the sterilization/melting time by the temperature measured by the sample temperature sensor (optional).</p> <p>Pressing the SAMPLE key lights the SAMPLE lamp. The temperature display screen indicates the temperature measured with the sample temperature sensor.</p>	37
Temperature output terminal (optional)	<p>This function transmits and output the measured temperature of controller at 4~20 mA.</p>	
Time up output terminal (optional)	<p>This function outputs the relay ("a" contact) at operation end.</p> <p>Contact spec: AC250V 1A (resistance load)</p>	39
Alarm output terminal (optional)	<p>This function outputs the relay ("a" contact) at warning of controller.</p> <p>Contact spec: AC250V 1A (resistance load)</p>	

## Operation Course/Functional Setting Key and Character

The following key operations and characters are used in the setting of operation course and function.

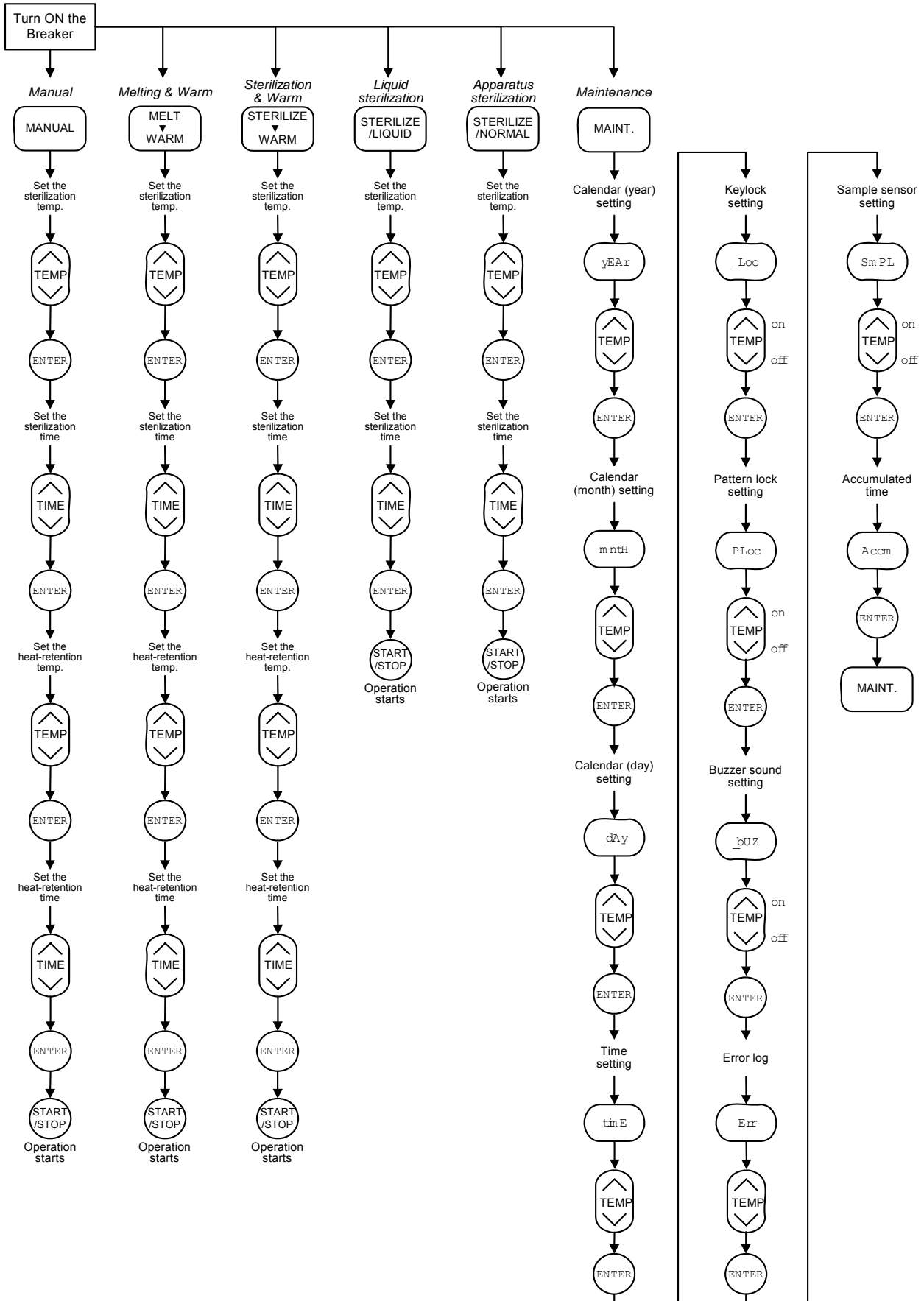

## Operation Course/Functional Setting Key and Character

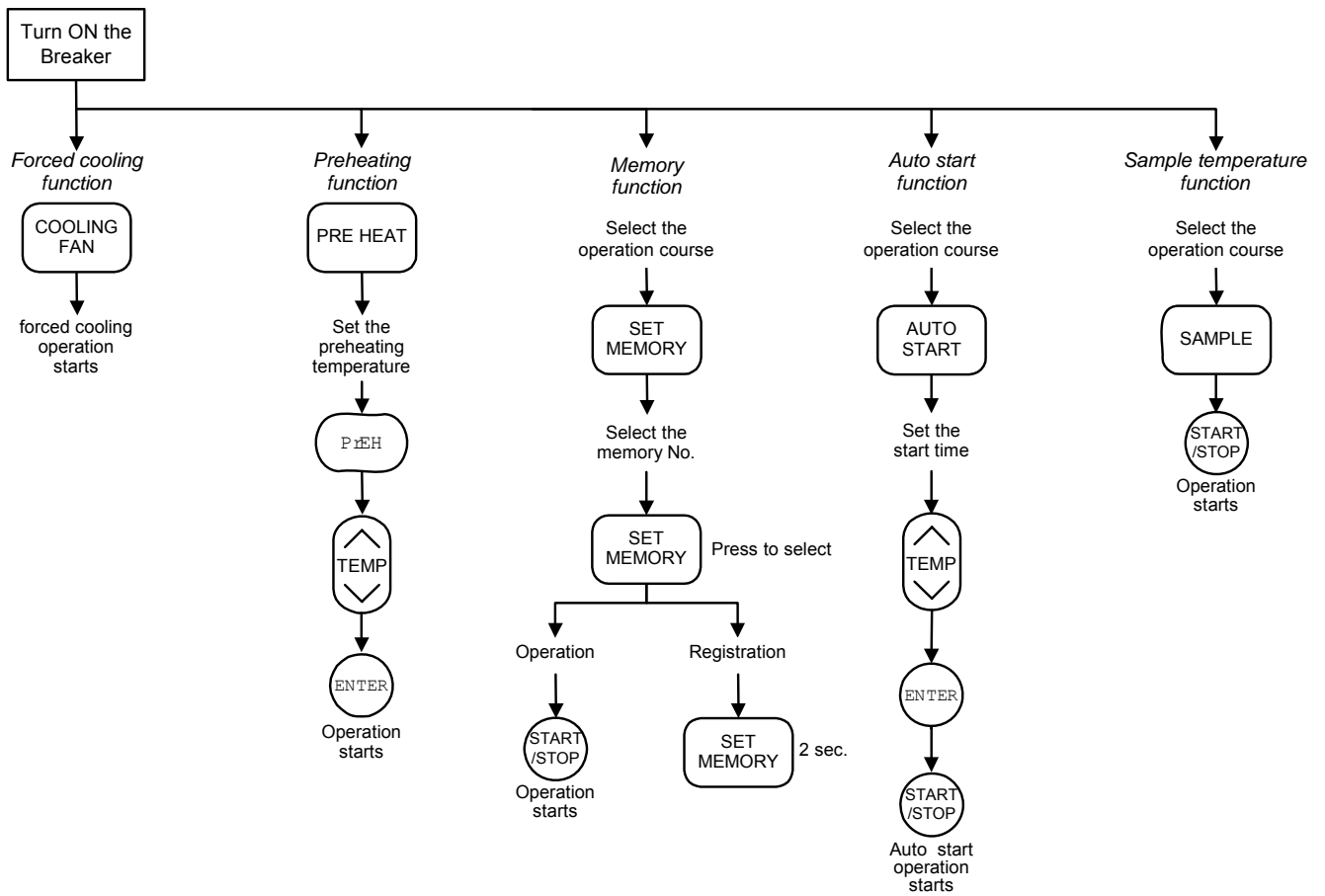

## Apparatus/Liquid Sterilization Course

Follow the procedures below for the setting of apparatus sterilization and liquid sterilization courses.

### 1. Turn on the earth leakage breaker

- The temperature display screen and time display screen display the current temperature inside the chamber and current time (standby state) respectively when the breaker is turned to on.

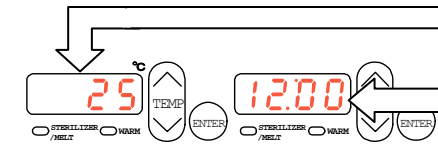

**Temperature display screen:**

displays current temperature inside the chamber.

**Time display screen:**

displays current time.

### 2. Select the operation course

- Press either the STERILIZE/NORMAL or STERILIZE/LIQUID key once. Press the key twice if other course has been already selected.

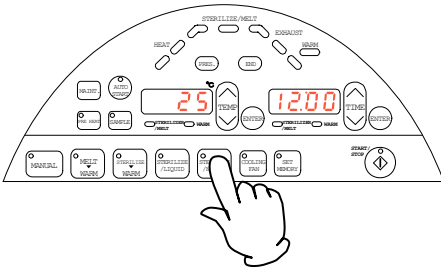

### 3. Set the sterilization temperature

- The sterilization temperature currently set is displayed with blinking on the temperature display screen. The STERILIZER/MELT lamp blinks. Press the  $\Delta$   $\nabla$  on the TEMP key and set the desired sterilization temperature.
- After setting the temperature, press the ENTER key to determine the value.

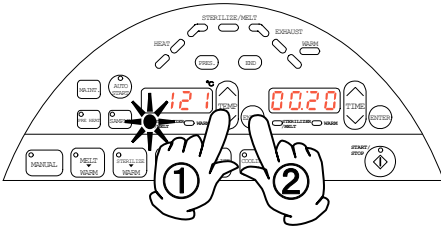

### 4. Set the sterilization time

- The sterilization time currently set is displayed with blinking on the time display screen. The STERILIZER/MELT lamp blinks. Press the  $\Delta$   $\nabla$  on the TIME key and set the desired sterilization time.
- After setting the time, press the ENTER key to determine the value.

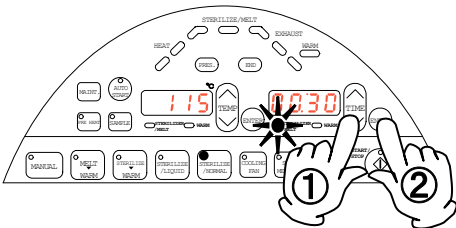

### 5. Start operation

- Press the START/STOP key. The equipment starts operation with the HEAT lamp blinks.

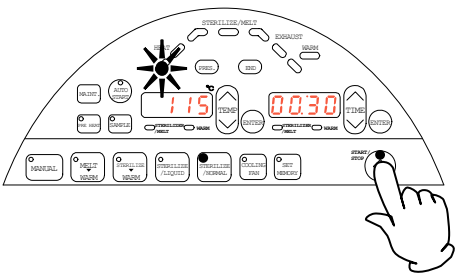

## Apparatus/Liquid Sterilization Course

---

### 6. End operation

- The time display screen displays “END” when the operation is completed.  
Press the START/STOP key. The equipment goes into the standby state. The lever on the cover is unlocked and the cover can be opened.

---

### To change or confirm the preset value during operation...

Preset values can not be changed while the equipment is in operation. Before starting operation, make sure to confirm them and change them if required.

Press the course key currently being operated to confirm the preset value while the equipment is in operation. The preset value has been displayed while the key is pressed.

---

### To abort operation...

Press the START/STOP key. The equipment stops operation.

In case the operation is aborted before the pressurization process, the END lamp lights up and the time display screen displays “END” without a buzzer sound.

In case the operation is aborted after the pressurization process, the equipment goes into the exhaust process.

---

### Power-off during operation

If the power is turned off due to a power failure, the operation is aborted. After the recovery, the “bLAc oUt” is displayed to notify the power failure. Press any key to delete the “bLAc oUt”.

In case the operation is aborted before the pressurization process, the END lamp lights up and the time display screen displays “END” without a buzzer sound.

In case the operation is aborted after the pressurization process, the equipment goes into the exhaust process.

## Sterilization & Warm/Melting & Warm/Manual Course

Follow the procedures below for the setting of sterilization & warm, melting & warm and manual course.

### 1. Turn on the earth leakage breaker

- The temperature display screen and time display screen display the current temperature inside the chamber and current time (standby state) respectively when the breaker is turned to on.

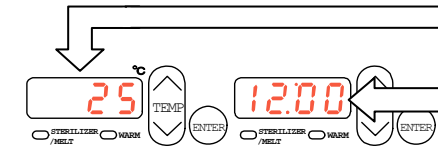

**Temperature display screen:**

displays current temperature inside the chamber.

**Time display screen:**

displays current time.

### 2. Select the operation course

- Press either the STERILIZE→WARM or MELT→WARM or MANUAL key once. Press the key twice if other course has been already selected.

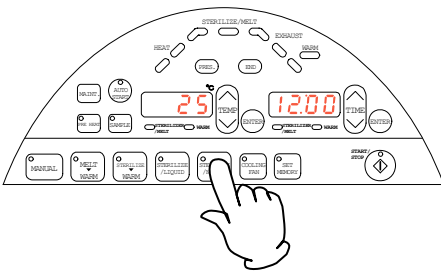

### 3. Set the sterilization temperature

- The sterilization temperature currently set is displayed with blinking on the temperature display screen. The STERILIZER/MELT lamp blinks. Press the  $\Delta$   $\nabla$  on the TEMP key and set the desired sterilization temperature.
- After setting the temperature, press the ENTER key to determine the value.

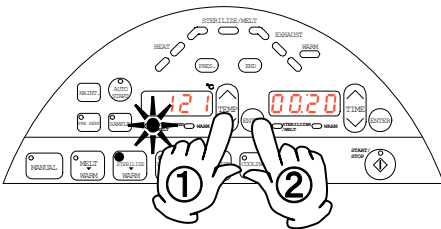

### 4. Set the sterilization time

- The sterilization time currently set is displayed with blinking on the time display screen. The STERILIZER/MELT lamp blinks. Press the  $\Delta$   $\nabla$  on the TIME key and set the desired sterilization time.
- After setting the time, press the ENTER key to determine the value.

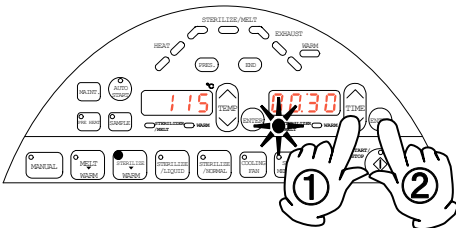

### 5. Set the heat-retention temperature

- The current heat-retention temperature is displayed with blinking on the temperature display screen. The STERILIZER/MELT lamp blinks. Press the  $\Delta$   $\nabla$  on the TEMP key and set the desired heat-retention temperature.
- After setting the temperature, press the ENTER key to determine the value. The setting of heat-retention time will follow.

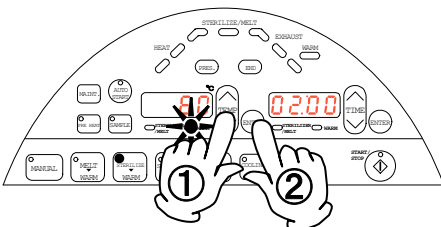

## Sterilization & Warm/Melting & Warm/Manual Course

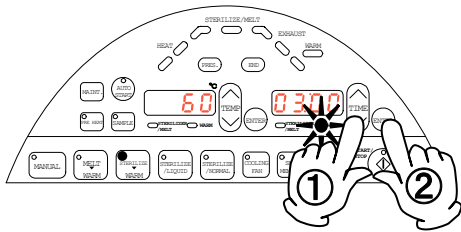

### 6. Set the heat-retention time

- ① The current heat-retention time is displayed with blinking on the time display screen. The STERILIZER/MELT lamp blinks. Press the  $\wedge \vee$  on the TIME key and set the desired heat-retention time.
- ❖ Set "00 : 00" when skipping the heat-retention process in the manual operation.
- ② After setting the time, press the ENTER key to determine the value.

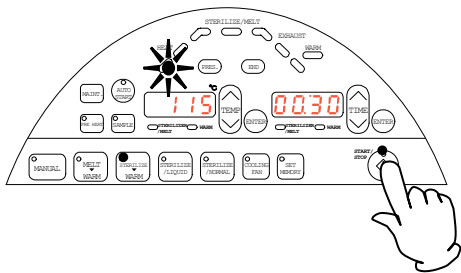

### 7. Start operation

- Press the START/STOP key.  
The equipment starts operation with the HEAT lamp blinks.

### 8. End operation

- The time display screen displays "END" when the operation is completed.  
Press the START/STOP key. The equipment goes into the standby state. The lever on the cover is unlocked and the cover can be opened.

### To change or confirm the preset value during operation...

Preset values can not be changed while the equipment is in operation. Before starting operation, make sure to confirm them and change them if required.

Press the course key currently being operated to confirm the preset value while the equipment is in operation. The preset value has been displayed while the key is pressed.

### To abort operation...

Press the START/STOP key. The equipment stops operation.

In case the operation is aborted before the pressurization process, the END lamp lights up and the time display screen displays "END" without a buzzer sound.

In case the operation is aborted after the pressurization process, the equipment goes into the exhaust process.

### Power-off during operation

If the power is turned off due to a power failure, the operation is aborted. After the recovery, the "bLAc oUt" is displayed to notify the power failure. Press any key to delete the "bLAc oUt".

In case the operation is aborted before the pressurization process, the END lamp lights up and the time display screen displays "END" without a buzzer sound.

In case the operation is aborted after the pressurization process, the equipment goes into the exhaust process.

The operation continues if aborted during the heat-retention process.



## Maintenance Mode

### Set the following functions;

Calendar, time, lock, pattern lock, buzzer sound, error log, sample temperature and accumulated time.

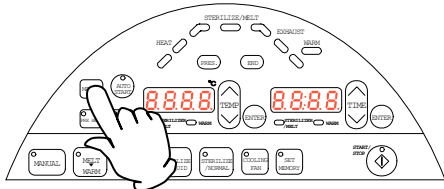

- ① Press the MAINT. key.

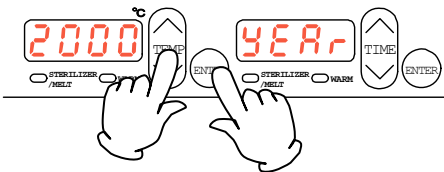

- ② The calendar (year) setting screen is displayed. The time display screen displays the character "yEAR", which indicates the calendar (year). The temperature display screen displays the value (year) with blinking. Press the  $\Delta \nabla$  on the TEMP key and set the desired year. Press the ENTER key to determine the value.

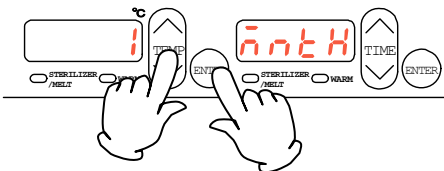

- ③ The calendar (month) setting screen is displayed. The time display screen displays the character "mntH", which indicates the calendar (month). The temperature display screen displays the value (month) with blinking. Press the  $\Delta \nabla$  on the TEMP key and set the desired month. Press the ENTER key to determine the value.

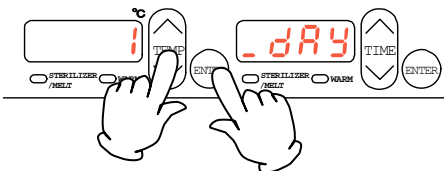

- ④ The calendar (date) setting screen is displayed. The time display screen displays the character "\_dAy", which indicates the calendar (date). The temperature display screen displays the value (date) with blinking. Press the  $\Delta \nabla$  on the TEMP key and set the desired date. Press the ENTER key to determine the value.

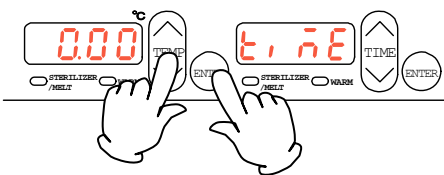

- ⑤ The time setting screen is displayed. The time display screen displays the character "timE", which indicates the time. The temperature display screen displays the value (time) with blinking. Press the  $\Delta \nabla$  on the TEMP key and set the desired time. Press the ENTER key to determine the value.

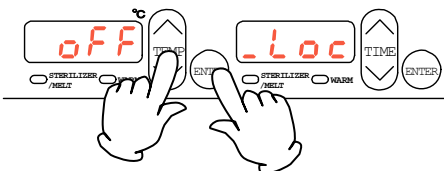

- ⑥ The lock setting screen is displayed. The time display screen displays the character "\_Loc", which indicates the lock setting. The temperature display screen displays "on" or "oFF" with blinking. Press the  $\Delta \nabla$  on the TEMP key to select "on" or "oFF". Press the ENTER key to determine the setting. (The setting is "oFF" at factory shipment.)

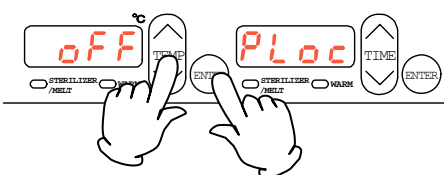

- ⑦ The pattern lock setting screen is displayed. The time display screen displays the character "PLoc", which indicates the pattern lock setting. The temperature display screen displays "on" or "oFF" with blinking. Press the  $\Delta \nabla$  on the TEMP key to select "on" or "oFF". Press the ENTER key to determine the setting. (The setting is "oFF" at factory shipment.)

## Maintenance Mode

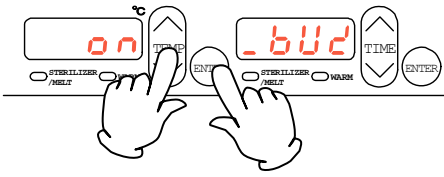

- ⑧ The buzzer setting screen is displayed.  
The time display screen displays the character "\_bUZ", which indicates the buzzer setting. The temperature display screen displays "on" or "oFF" with blinking.  
Press the  $\wedge \vee$  on the TEMP key to select "on" or "oFF".  
Press the ENTER key to determine the setting.  
(The setting is "on" at factory shipment.)

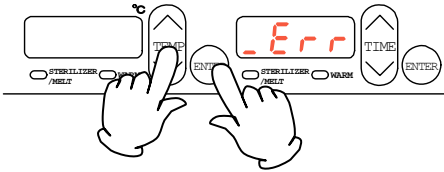

- ⑨ The error log screen is displayed.  
The time display screen displays the character "\_Err", which indicates the error log. The temperature display screen displays nothing.  
Press the  $\wedge \vee$  on the TEMP key to check the error log.  
The content of errors and their time of occurrence are displayed.  
Press the ENTER key to go into the setting screen for sample temperature.

### Error log display

For example, Error 1 occurred at 11:59 p.m. on December 31, 2005;

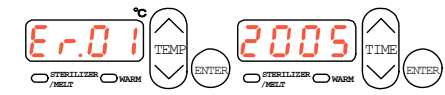

Displayed alternately every two seconds

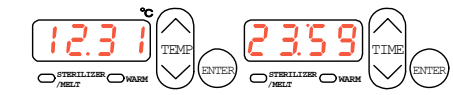

Press the  $\wedge \vee$  on the TEMP key to select the error No.

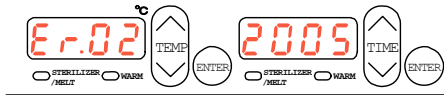

- ⑩ The sample temperature setting screen is displayed.  
The time display screen displays the character "SmPL", which indicates the sample temperature setting. The temperature display screen displays "on" or "oFF" with blinking.  
Press the  $\wedge \vee$  on the TEMP key to select "on" or "oFF".  
Press the ENTER key to determine the setting.  
(Set "on" here when an optional accessory is attached. The setting is "oFF" at factory shipment.)

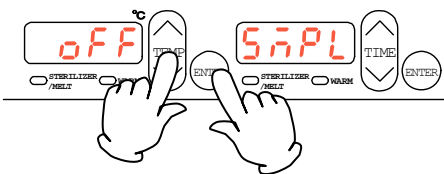

## Maintenance Mode

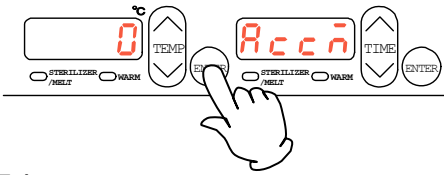

Ex):  
when the accumulated time is 39999 hours

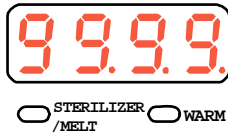

- ⑪ The accumulated time screen is displayed.  
The time display screen displays the character "Accm", which indicates the accumulated time. The temperature display screen displays the accumulated time.  
Check the time and press the ENTER key to determine it.
- ❖ The accumulated time function accumulates the current-carrying time by the hour.
  - When the accumulated time is 10000 hours or more:  
→The decimal-point character for one-hour unit lights up.
  - When the accumulated time is 20000 hours or more:  
→The decimal-point character for ten-hour unit lights up.
  - When the accumulated time is 3000 hours or more:  
→The decimal-point character for hundred-hour unit lights up.
  - This function does not accumulate time more than 4000 hours. (The maximum is 39999 hours.)
- ❖ The accumulated time can be reset by pressing the  $\wedge$  and  $\vee$  on the TEMP key at the same time while the accumulated time is displayed.

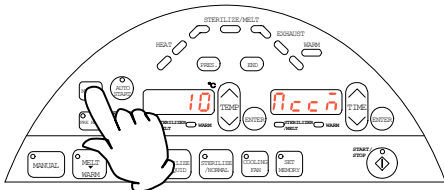

- ⑫ The setting returns to Step ⑪.  
Press the MAINT. key to terminate the setting procedures.

## Forced Cooling Function / Preheating Function

### Forced cooling function

This function turns on the cooling fan during exhaust process to shorten the cooling time. The cooling fan is turned on during switching to the exhaust process in the apparatus sterilization course. In other courses, it starts to run at the saturated vapor temperature (refer to the graph on Page 15) of  $-2^{\circ}\text{C}$  or less. It stops when the equipment goes into the standby state after operation is completed, or when the temperature inside the chamber reaches  $60^{\circ}\text{C}$ . The function can be set anytime before and during operation of equipment.

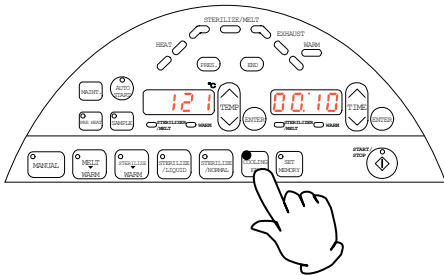

- ① Press the COOLING FAN key.  
The COOLING FAN lamp lights up and the function become available.

### Preheating function

This function keeps the temperature of feed water inside the chamber with the preset temperature. The range of preset temperature is from  $45^{\circ}\text{C}$  to  $80^{\circ}\text{C}$ . The operation automatically ends after five hours. The preheating operation function remains after the power is restored due to a power failure.

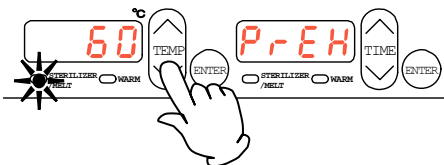
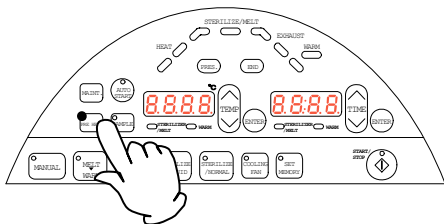

- ① Press the PRE HEAT key.
- ② The preheating function screen is displayed.  
The time display screen displays the character "PrEH", which indicates the preheating function. The temperature display screen displays the value (temperature). The temperature display screen displays with blinking the preheating temperature currently set and the STERILIZE/MELT lamp blinks.  
Press the  $\wedge \vee$  on the TEMP key to set the desired preheating temperature.
- ③ After setting the temperature, press the ENTER key or START/STOP key to determine the value. This starts the preheating operation.
- ④ Press the PRE HEAT key to abort the preheating operation.

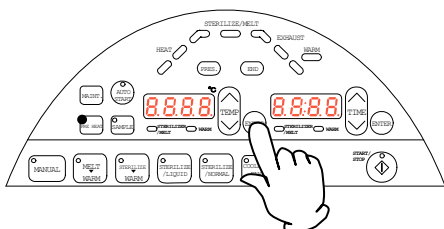

## Memory Function

### Memory function

Each operation course has three memory banks, where registration and read of settings are possible. The following settings can be stored into the memory.

- Sterilization (melting) temperature
- Sterilization (melting) time
- Heat-retention temperature
- Heat-retention time
- ON/OFF of forced cooling function

### 1. Register the setting to the memory.

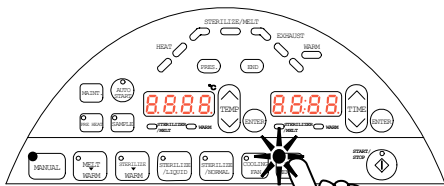

- ① Make sure that the course where the memory is to be registered is selected and then press the SET MEMORY key. The SET MEMORY lamp blinks.

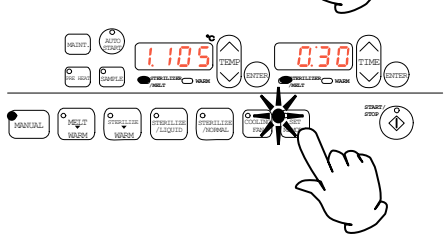

- ② The memory registration screen is displayed. The memory No. is displayed on the highest-order digit of temperature display screen. The temperature/time setting display for sterilization or melting switches to 1, 2, 3 or normal mode in this order every time the SET MEMORY key is pressed.

As for the courses that include the heat-retention setting, the temperature and time of the setting can be checked by pressing the ENTER key.

The COOLING FAN lamp lights up when forced cooling function is set to "on".

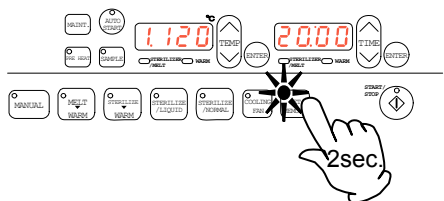
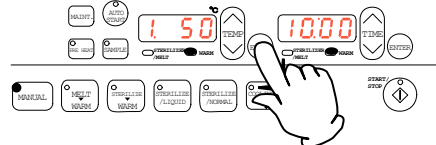

- ③ Select the memory No. that the setting is overwritten and then press the SET MEMORY key for two seconds. The displayed preset value changes. This completes the registration of setting.

### 2. Operation procedures with the registered setting

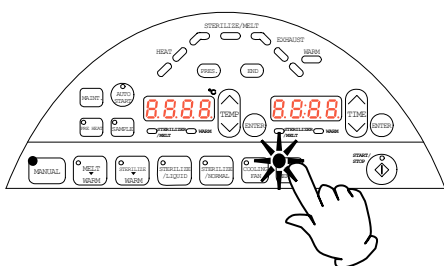

- ① Make sure that the course to be operated is selected and then press the SET MEMORY key. The SET MEMORY lamp blinks.

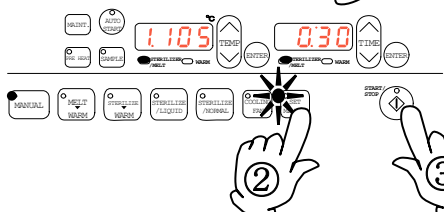

- ② The memory confirmation screen registered is displayed. Select the memory No. by the SET MEMORY key.
- ③ Press the START/STOP key. The setting being displayed is read. The equipment starts operation using the setting.

## Auto Start Function

### Auto start function

This function automatically starts the operation of equipment at the specified time with the selected course. The time can be set in increments of one minute within the range from 00 : 00 to 23 : 59. The auto start function remains after the power is restored due to a power failure.

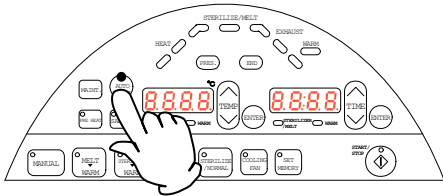

- ① Make sure that the course to be operated is selected and then press the AUTO START key. The AUTO START lamp lights up.



- ② The auto start time screen is displayed. The time display screen displays the auto start time currently set with blinking. Press the  $\wedge$   $\vee$  on the TIME key and set the desired time.

When starting the operation at 12:00...

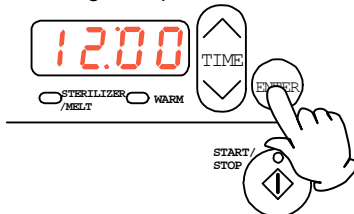

- ③ Set the desired auto start time and then press the ENTER key or START/STOP key to determine the value.



- ④ The AUTO START lamp continues blinking until the equipment starts operation. Press the START/STOP key while the AUTO START lamp is blinking to confirm the operation start time.
  - ❖ The procedure above is possible only when the cover on the main unit is locked.
- ⑤ Press the AUTO START key to abort the preheating operation.

## Sample Temperature Function

### Sample temperature function

This function counts the sterilization/melting time by the temperature measured by the sample temperature sensor. Set "on" to the setting of sample temperature sensor in the maintenance setting.

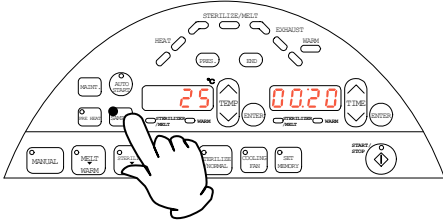

- ① Make sure that the course to be operated is selected and then press the SAMPLE key.  
The SAMPLE lamp lights up and the temperature display screen displays the temperature measured by the sample temperature sensor.
- ② Press the START/STOP key to start the operation. During the sterilization and melting processes, the display can not be switched.

## Sample Temperature Function

The preset values at factory shipment are as follows.

The initial setting values of operation						
Course	Sterilization temp.	Sterilization time	Melting temp.	Melting time	Heat-retention temp.	Heat-retention time
Apparatus sterilization	121°C	20 min.	—	—	—	—
Liquid sterilization	121°C	20 min.	—	—	—	—
Sterilization & Warm	121°C	20 min.	—	—	50°C	2 hours
Melting & Warm	—	—	100°C	10 min.	50°C	2 hours
Manual	121°C	20 min.	—	—	50°C	2 hours

The initial setting values of function	
Function	Value
Preheating	45°C
Forced cooling	OFF
Key lock	OFF
Pattern lock	OFF
Buzzer	ON
Error log	—
Sample temperature	OFF
Accumulated time	0 hour



## External Output Terminal (optional)

### Precautions



- Operate this product according to the procedure described in this Operation Manual. Failure to follow the operation procedure described herein may result in a problem. The guarantee will not apply if you operate the product in the wrong manner.



### **CAUTION!**



- Turn off the breaker before connecting the cables.
- Connect a recorder or another appliance of 600 W or less in input impedance to the temperature output terminal.
- Securely fasten all connections with the screws attached to the terminal block.

### Connection procedure



- Connect the cables to the appropriate terminals.
- When using temperature output, use a shielded wire for the cable to be connected to prevent noise.

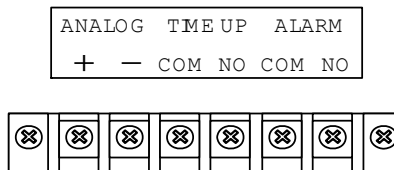

**Connection terminal**

## External Output Terminal (optional)

### Specification

Temperature Output (ANALOG)	<ul style="list-style-type: none"> <li>• The current (mA) corresponding to the measured temperature is output.</li> <li>• Output temperature range: 0 to 160°C</li> <li>• Output current: 4 to 20mA</li> <li>• Load: 600Ω or bellow</li> <li>• Resolution: <math>\pm 2^{\circ}\text{C}</math> (<math>\pm 0.2\text{mA}</math>)</li> <li>• Connection: M4 screw terminal block</li> </ul>
Time-up Output (TIME UP)	<ul style="list-style-type: none"> <li>• It is output when operation is completed, including an abortion.</li> <li>• a-contact (relay contact)</li> <li>• Contact capacity: 250V AC, 1A (resistance load)</li> <li>• Connection: M4 screw terminal block</li> </ul>
Alarm Output (ALARM)	<ul style="list-style-type: none"> <li>• It is output when an abnormality is detected. Refer to "Safety Device and Error Code" in Page 45. It is not, however, output when an abnormality in the bottle.</li> <li>• a-contact (relay contact)</li> <li>• Contact capacity: 250V AC, 1A (resistance load)</li> <li>• Connection: M4 screw terminal block</li> </ul>

**Temperature/current output table**

Temperature (°C)	Output current (mA)
0	4
20	6
40	8
60	10
80	12
100	14
120	16
140	18
160	20

## **WARNING!**

### **If a problem occurs**

-  If smoke or strange odor should come out of this unit for some reason, turn off the power key right away, and then turn off the circuit breaker and the main power. Immediately contact a service technician for inspection. If this procedure is not followed, fire or electrical shock may result. Never perform repair work yourself, since it is dangerous and not recommended.

### **Measure for flammability and handling of flammable solvent**

-  This unit is not designed as the explosion-proof construction. Pay special attention to the handling of the sample to be handled with this unit on the consumption with the explosive material, flammable material, and similar ones. The flammable material may be vaporized by leaving it at the temperature higher than room temperature, and could cause the fire or explosion. When handling such material, provide ventilation with enough before the operation. (Refer to page 56.)

### **Keep the unit well-ventilated**

-  Keep the heat releasing outlets in the side and back of the unit open during operation. If they are closed, the inside temperature of the unit may increase, its performance may deteriorate, or an accident, malfunction or fire may result.

### **Exercise care not to allow a liquid to get on the unit**

-  Exercise care not to allow a liquid to get on the unit or enter the unit through the heat releasing outlets in the side or back of the unit. If it enters the unit, stop the operation. Otherwise, an accident, malfunction, electric shock or fire may result.

### **Do not drop metallic pieces into the unit**

-  Do not drop metallic pieces, such as clips, staples and screws, into the unit. If such a metallic piece has dropped into the unit, turn it off. An accident, malfunction, electric shock or fire may result.

### **Do not open the panels and covers**

-  Do not operate the unit with the fixed panels and covers open. An accident, malfunction or electric shock may result.

### **Do not modify**

-  Do not modify this unit. An accident, malfunction, electric shock or fire may result.

## **CAUTION!**

### **Do not step on this unit**

 Do not step on this unit. It will cause injury if this unit fall down or break.

### **Do not place or drop anything on the unit**

 Do not place or drop anything on the unit. Since the unit contains precision components, it may malfunction due to vibration, impact, etc.

### **During a thunder storm**

 During a thunderstorm, turn off the power key immediately, then turn off the circuit breaker and the main power. If this procedure is not followed, fire or electrical shock may be caused.

### **Countermeasure for stop operation during night or long-term stop**

 Turn off the power of earth leakage breaker and disconnect the power cord from the power source before stopping the operation of equipment overnight or for a long time.

### **Do not touch the hot section**

 The temperature on the cover and top board on the chamber are very hot during operation or just after operation is completed. Do not touch these sections to avoid a burn injury.

### **When opening the cover...**

 Make sure that the pressure gauge reading has decreased to 0(zero) MPa before opening the cover. Open the cover slow carefully. The high-temperature and pressure vapor blows out if the cover is opened during high pressure.

### **When opening/closing the door...**

 Do not put your hands or face into the traveling range (space) of door when it is opened or closed. The door may contact, which may cause an injury.

### **When draining water...**

 The water in the chamber is very hot just after operation is completed. Be careful not to get a burn injury. Drain the water after the water is sufficiently cooled down. Do not drain water during operation. The hot water blows out if the drain valve is opened while the pressure is increasing.

### **Do not damage the packing on the cover or flange on the chamber**

 Damage or dirt on these areas may cause the vapor leakage, which may be the cause of burn injury. Keep these sections always clean. Do not damage them with the rack when taking out and putting in the sterile samples. The packing degrades wit time. It must be replaced if vapor leak occurs frequently. In this case consult with the selling office where you purchased or our sales office.

### **Replace the packing early**

 The packing is a consumable. If it shows the sign of damage or hardening, replace it early. Please consult with the selling office where you purchased or our sales office for the replacement of packing.

### **Do not perform procedures other than described in this document**

 Do not perform procedures other than described in this document. Otherwise an unexpected accident may occur.

## Daily Inspection and Maintenance

For the safety use of this unit, please perform the daily inspection and maintenance without fail. Using the city water to this unit might attach dirt. Do inspect and maintain this point while performing daily inspection and maintenance.

### **WARNING!**

- Disconnect the power cable from the power source when doing an inspection or maintenance unless needed.
- Perform the daily inspection and maintenance after returning the temperature of this unit to the normal one.
- Do not disassemble this unit.

### **CAUTION!**

- Use a well-drained soft cloth to wipe dirt on this unit. Do not use benzene, thinner or cleanser for wiping. Do not scrub this unit. Deformation, deterioration or color change may result in.

## Monthly maintenance

- Check the earth leakage breaker function.
  1. Connect the power cord.
  2. Turn the breaker on.
  3. Push the red test switch by a ballpoint pen etc.
  4. If there is no problem, the earth leakage breaker will be turned off.
- Clean the silencer.

The exhaust hose is equipped with a silencer on its end to reduce the noise generated during air purge.

  - Remove the silencer and wash it with water. It contains a backwater prevention ball. Make sure not lose the ball when the silencer is removed.
  - After cleaning, put the ball first into the silencer and then fix the silencer

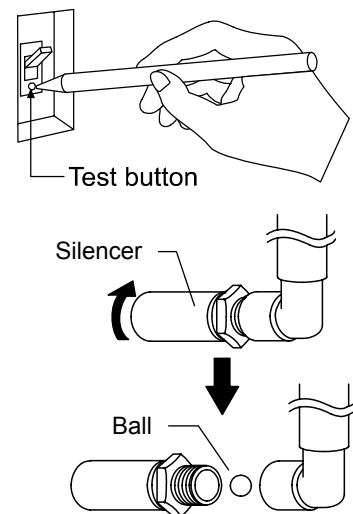

## Filter cleaning

- If the filter on the bottom of chamber is clogged with dust or dirt, the equipment can not drain the water. Clean it appropriately as required.
  - The filter is inserted in the drain outlet. Pull it out to sweep it.
  - Insert it in place after cleaning.

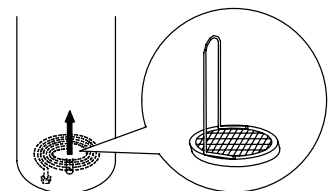

## Cleaning inside the chamber

- Use soft sponge to clean inside the chamber not to damage the surface inside the chamber. Do not remove the filter on the bottom of chamber at cleaning. If it is removed, the pipe fitting is clogged with dirt inside the chamber.
- The heater and sensor are provided on the bottom inside the chamber. Make sure not to bend or damage the filter.

For any questions, contact the dealer who you purchased this unit from, or the nearest sales division in our company.

## When not using this unit for long term / When disposing

### **CAUTION!**

#### When not using this unit for long term...

- Turn off the power and disconnect the power cord.

### **WARNING!**

#### When disposing...

- Keep out of reach of children.
- Consult with the specialized disposal services when disposing the equipment.

### ***Environmental protection should be considered***

We request you to disassemble this unit as possible and recycle the reusable parts considering to the environmental protection. The feature components of this unit and materials used are listed below.

Component Name	Material
<b>Exterior Parts</b>	
Outer covering	Bonderizing steel plate baked with melamine resin coating, ABS resin
Chamber, Cover	Stainless steel SUS304
Packing	Silicon rubber
Plates	PET resin film
<b>Electrical Parts</b>	
Switches, Relay	Resin, copper
Circuit boards	Composite of glass fiber and other
Heater	SUS pipe heater
Power cord	Synthetic rubber coated wiring materials, copper and nickel
<b>Piping Parts</b>	
Hoses	Ethylene propylene tube
Pipes	Copper, Copper alloy

## Safety Device and Error Code

This unit has an automatic diagnosis function built in the controller and safety devices independent of the controller. The table below shows the cause and the solution method when the safety device operates.

### Error Code:

If an error in use or equipment a failure occurs, the temperature display screen on the operating panel displays the corresponding error code and the alarm buzzer sounds. The buzzer stops by pressing any key. In case an error occurs, check the error code and turn off the earth leakage breaker.

Safety Device	Notify	Cause/Solution
Sensor trouble detection	"Er.01" appears	<ul style="list-style-type: none"> <li>• Failure in temperature input circuit.</li> <li>• Temperature sensor is broken or disconnected.</li> <li>• The measured temperature is out of the display range.</li> <li>❖ Make a call for service.</li> </ul>
SSR short-circuit detection	"Er.02" appears	<ul style="list-style-type: none"> <li>• SSR is in short-circuit</li> <li>❖ Make a call for service.</li> </ul>
Heater disconnecting detection	"Er.03" appears	<ul style="list-style-type: none"> <li>• Heater is disconnected.</li> <li>❖ Make a call for service.</li> </ul>
Cover locking error	"Er.04" appears	<ul style="list-style-type: none"> <li>• The cover is unlocked during operation.</li> <li>❖ Make a call for service.</li> </ul>
Cover unlocking error	"Er.05" appears	<ul style="list-style-type: none"> <li>• The cover is not unlocked at releasing.</li> <li>❖ Make a call for service.</li> </ul>
Incorrect bottle position	"Er.06" appears	<ul style="list-style-type: none"> <li>• Bottle is attached incorrectly.</li> <li>❖ Open the door and attach the drain bottle correctly.</li> </ul>
Overheat error	"Er.07" appears	<ul style="list-style-type: none"> <li>• The chamber temperature rises to 140°C or above.</li> <li>• The temperature of "preset temperature + (plus) 3°C or above" is continued for one minute during sterilization process.</li> <li>• The temperature of "preset temperature + (plus) 10°C or above" is continued for ten minutes during heat-retention process.</li> <li>❖ Make a call for service.</li> </ul>
Sample sensor (optional) disconnection	"Er.08" appears	<ul style="list-style-type: none"> <li>• Disconnection or abnormality of sample sensor.</li> <li>• The setting is set to "on" when the sensor is not attached.</li> <li>❖ Check the setting referring to "Maintenance Mode" in Page 31.</li> <li>❖ Make a call for service.</li> </ul>
Exhaust valve error	"Er.09" appears	<ul style="list-style-type: none"> <li>• Failure in exhaust valve.</li> <li>❖ Make a call for service.</li> </ul>
A/D conversion error	"Er.14" appears	<ul style="list-style-type: none"> <li>• Failure in electrical parts.</li> <li>❖ Make a call for service.</li> </ul>
Memory error	"Er.15" appears	<ul style="list-style-type: none"> <li>• Failure in preset value of memory.</li> <li>❖ Make a call for service.</li> </ul>

## Safety Device and Error Code

---

Internal communication error	“Er.17” appears	<ul style="list-style-type: none"><li>• Communication error between the control board and display board.</li><li>❖ Make a call for service.</li></ul>
Water level error	“Er.20” appears	<ul style="list-style-type: none"><li>• Lack of water supply</li><li>❖ Supply water.</li><li>❖ Check the amount of water to be supplied referring to 9 of "Pour water into the chamber" in Page 11. If the error is not cancelled, contact our service department.</li></ul>
Safety valve	Safety valve is operated.	<ul style="list-style-type: none"><li>• Pressure rise inside the chamber or safety valve failure.</li><li>❖ Make a call for service.</li></ul>



## Trouble Shooting

Phenomenon	Check point
The unit does not start to operate although the leakage breaker is turned on.	<ul style="list-style-type: none"> <li>• Check if the power cable is securely connected to the power supply.</li> <li>• Check if the power fails.</li> <li>• Check the power voltage.</li> </ul>
The screen displays the error code and the alarm buzzer sounds.	<ul style="list-style-type: none"> <li>• Check the error code. (refer to "Safety Device and Error Code" on page 45.)</li> </ul>
Exhaust failure or safety valve is operated.	<ul style="list-style-type: none"> <li>• The hose to the drain bottle is twisted or clogged.</li> <li>• The exhaust outlet inside the chamber is blocked with the sterile samples.</li> <li>• Too much samples are stored.</li> </ul>
Drain failure	<ul style="list-style-type: none"> <li>• The filter is clogged.</li> </ul>
Sterilization temperature does not rise or pressure inside the chamber does not rise.	<ul style="list-style-type: none"> <li>• The preset value is lower than the temperature inside the chamber.</li> <li>• The power supply voltage is low.</li> <li>• The ambient temperature is too low.</li> <li>• The cover is not securely closed.</li> <li>• The packing or flange is damaged.</li> </ul>
Pressure inside the chamber rises with the solenoid valve opened.	<ul style="list-style-type: none"> <li>• The exhaust outlet inside the chamber is blocked.</li> </ul>
The temperature changes during operation of equipment.	<ul style="list-style-type: none"> <li>• An inadequate preset temperature is set.</li> <li>• Check if the power supply voltage is low.</li> <li>• The variation in ambient temperature is too large.</li> </ul>
Too much vapor blows out, or hot water blows out from the drain bottle.	<ul style="list-style-type: none"> <li>• The drain bottle does not contain water.</li> <li>• The water in the drain bottle is hot.</li> <li>• The exhaust hose is removed or broken.</li> <li>• The silicon plug is not fitted securely.</li> <li>• The water in the vapor cup is full.</li> <li>• The water level in the drain bottle is above the drain level.</li> </ul>
Water leaks.	<ul style="list-style-type: none"> <li>• The drain valve is not securely closed.</li> <li>• The drain bottle contains too much water.</li> </ul>
Operation halts in standby state.	<ul style="list-style-type: none"> <li>• The cover is not securely closed. Check it referring to the 13 of "Close the cover" in Page 12.</li> </ul>
Large noise during air purge.	<ul style="list-style-type: none"> <li>• Check if the silencer is removed, Check the connection of silencer inside the drain bottle referring to the 6 of "Set the drain bottle" in Page 10.</li> </ul>
Cover does not open.	<ul style="list-style-type: none"> <li>• The power is turned off.</li> <li>• The sterilization process is not completed.</li> </ul>

**In the case if the error other than listed above occurred, turn off the power switch and primary power source immediately. Contact the shop of your purchase or nearest Yamato Scientific Service Office.**

### In Case of Request for Repair

If the failure occurs, stop the operation, turn OFF the power switch, and unplug the power plug. Please contact the sales agency that this unit was purchased, or the Yamato Scientific's sales office.

#### < Check following items before contact >

- ◆ Model Name of Product
  - ◆ Production Number
  - ◆ Purchase Date
  - ◆ About Trouble (in detail as possible)
- } See the production plate attached to this unit.

### Minimum Retention Period of Performance Parts for Repair

The minimum retention period of performance parts for repair of this unit is 7 years after discontinuance of this unit.

The "performance part for repair" is the part that is required to maintain this unit.

# Specification

Product name		Sterilizer				
Model		SN200C/210C	SN300C/310C	SN500C/510C	SQ500C/510C	SQ800C/810C
Performance	Temperature control range	105 to 135°C (sterilization), 65 to 100°C (melting), 45 to 60°C (heat-retention), 45 to 80°C (preheating)				
	Maximum Operational Pressure	0.255MPa				
	Operational ambient temperature	5°C~35°C				
Cover mechanism		Manual up and down open/close system (safety lock mechanism attached)				
Chamber part	Heater	100V 600W × 2	100V 800W × 2	100V 950W × 2	100V 1000W × 2	
	Exhaust valve	For full open and slow exhaust (one each)				
	Option port	For sample sensor (1/4), recorder (1/4) and connection to pressure gauge (branched from the electromagnetic exhaust duct)				
	Cooling fan	Axial fan motor				
Configurations	Temperature control system	PID control by microcomputer				
	Setting/display method	Digital setting by UP/DOWN key / Digital display				
	Timer	Range: 0 or 1min to 99h59min, Resolution: 1minute				
	Operation courses	Apparatus sterilization, Liquid sterilization, Sterilization & Warm, Melting & Warm, Melting & Heat-retention, Manual				
Other functions		Key lock, Auto start, Memory, Preheating, Forced cooling, Pattern lock, Error logging (up to 20 errors), Accumulated time, Time display, Buzzer, Sample temperature sensor (optional)				
Safety devices		Sensor failure detection, SSR short circuit detection, Heater disconnection detection, Water level detection (liquid expansion method), Warning about setting error in drain bottle, Cover lock error detection, Memory error detection, Pressure safety valve (0.255MPa)				
Pressure vessel standard		Small-sized pressure vessel (notification of installation is not required)				
Standard	Effective dimensions of chamber (Diameter × Depth mm)	300 × 305	300 × 445	300 × 665	370 × 470	370 × 750
	External dimensions* (W × D × H mm)	400 × 530 × 840	460 × 590 × 848	460 × 590 × 1058	520 × 660 × 846	520 × 660 × 1161
	Effective capacity of chamber	20L	32L	47L	50L	80
	Weight	Approx. 65 kg	Approx. 75 kg	Approx. 85 kg	Approx. 95 kg	Approx.105 kg
	Power supply (50/60Hz)	SN200C: 100V-120V AC 12.5A-15A	SN300C: 100V-120V AC 16.5A-20A	SN500C: 100V-120V AC 19.5A-23.5A	SQ500C: 100V-120V AC 20.5A-24.5A	
		SN210: 200V-240V AC 6.5A-7.5A	SN310: 200V-240V AC 8.5A-10A	SN510: 200V-240V AC 10A-12A	SQ510: 200V-240V AC 10.5A-12.5A	
Power cord		3m outside the equipment				
Accessories	Rack × 2 OMS-60 (dia205×depth204 mm)	Rack × 2 OMS-70 (dia262×depth204 mm)	Rack × 3 OMS-70 (dia262×depth204 mm)	Rack × 2 OMS-90 (dia332×depth195.5mm)	Rack × 3 OMS-90 (dia332×depth195.5mm)	
	Vapor cup, Drain bottle, Drain board, Filter, Instruction manual					

\*: The external dimensions does not include the dimension of projection areas.

## SN200C/300C/500C, SQ500C/800C

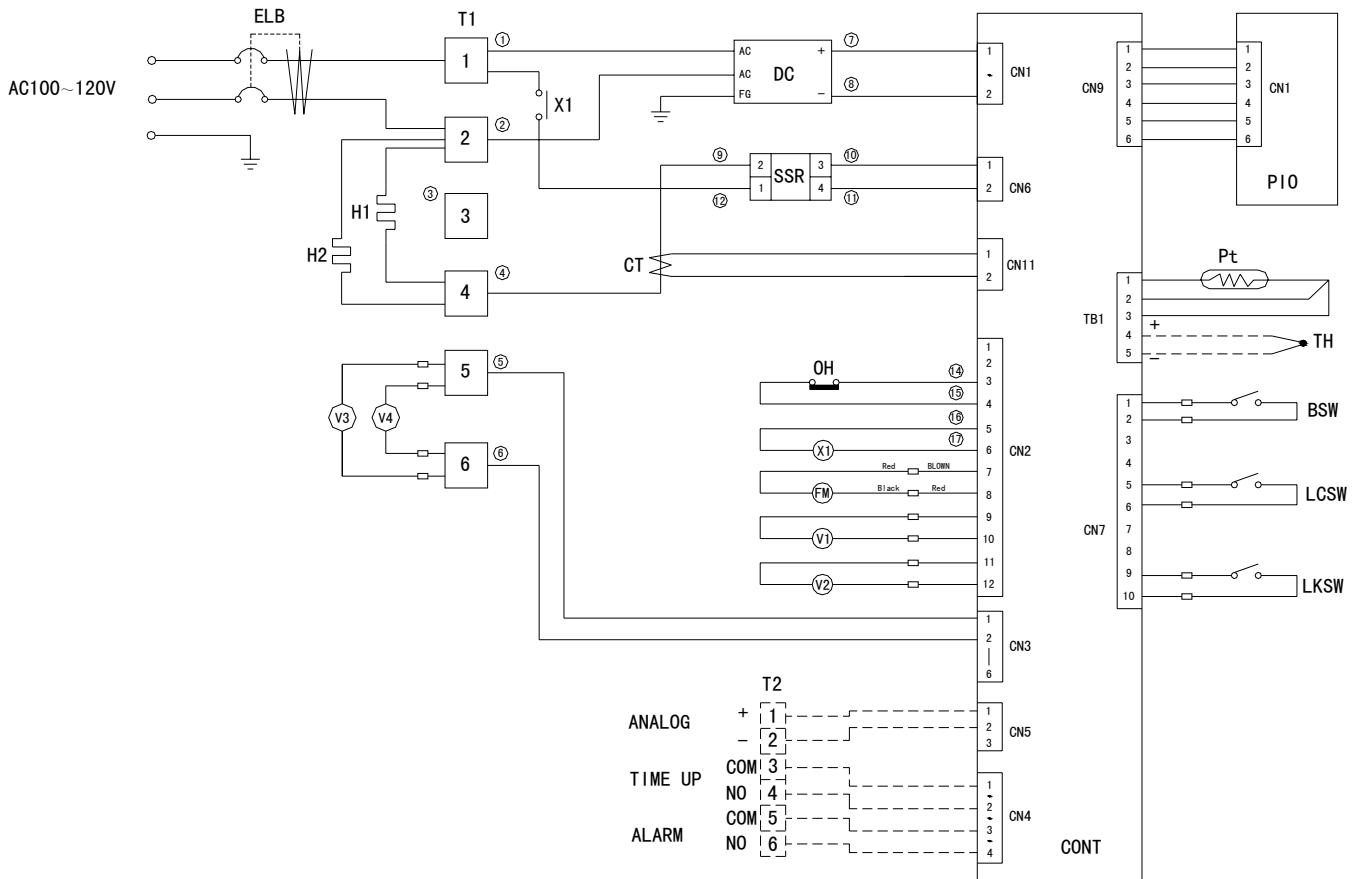

Symbol	Part name	Symbol	Part name
ELB	Earth leakage breaker	OH	Thermostat (for water level detection)
T1, 2	Terminal block	V1	Solenoid valve (full open)
H1, 2	Heater	V4	Solenoid valve (full open)
DC	Switching power supply (DC24V)	V2	Solenoid valve (slow exhaust)
SSR	Solid state relay	V3	DC solenoid (cover lock)
CT1	Current sensor	BSW	Limit switch (bottle detection)
Pt	Sensor for chamber	LCSW	Limit switch (lock lever detection)
TH	Sensor for sample (K)	LKSW	Limit switch (cover lock solenoid valve detection)
FM	Fan motor	CONT	PLANAR board
X1	Relay	PIO	Display board

## SN210C/310C/510C, SQ510C/810C

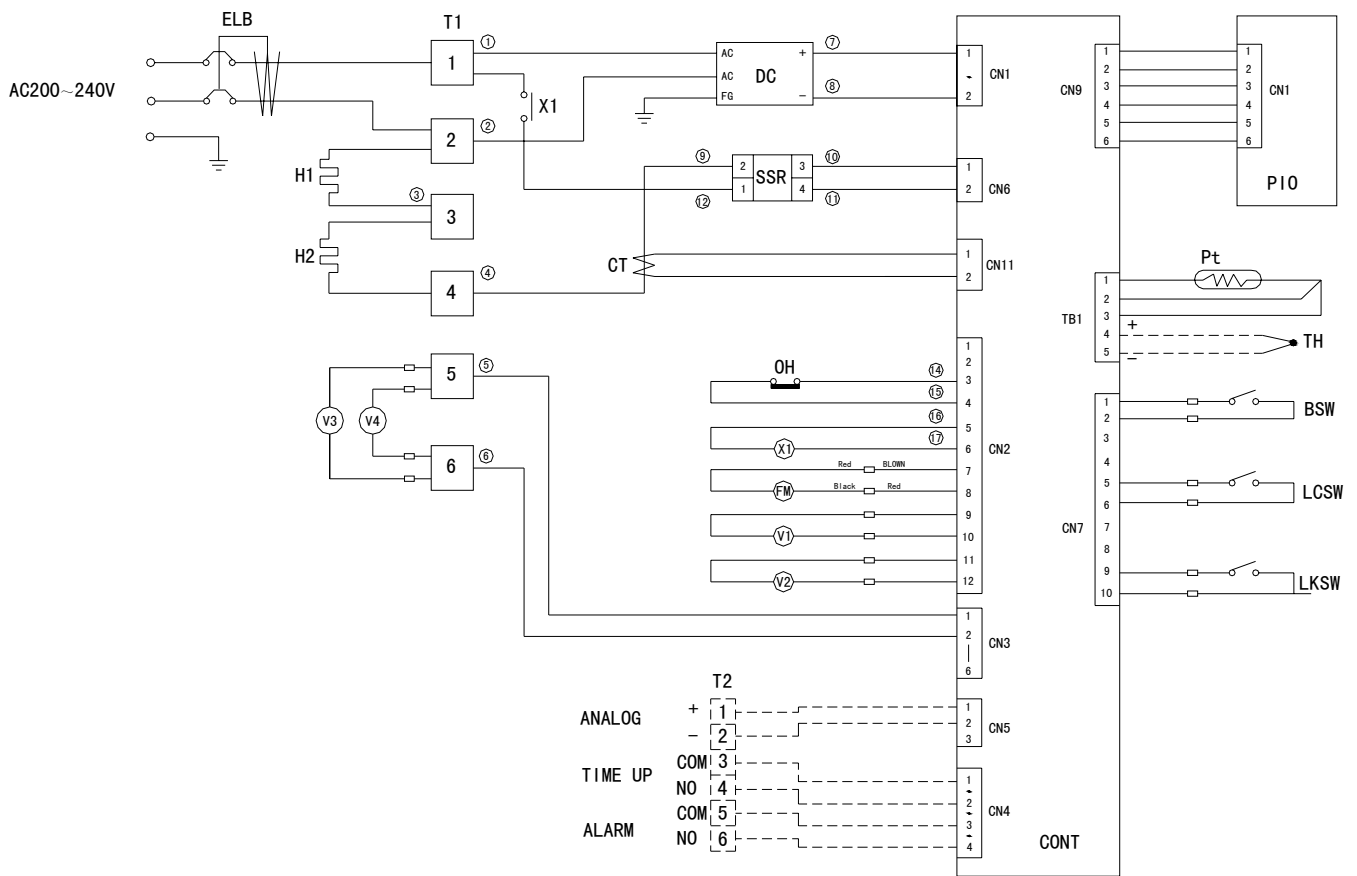

Symbol	Part name	Symbol	Part name
ELB	Earth leakage breaker	OH	Thermostat (for water level detection)
T1, 2	Terminal block	V1	Solenoid valve (full open)
H1, 2	Heater	V4	Solenoid valve (full open)
DC	Switching power supply (DC24V)	V2	Solenoid valve (slow exhaust)
SSR	Solid state relay	V3	DC solenoid (cover lock)
CT	Current sensor	BSW	Limit switch (bottle detection)
Pt	Sensor for chamber	LCSW	Limit switch (lock lever detection)
TH	Sensor for sample (K)	LKSW	Limit switch (cover lock solenoid valve detection)
FM	Fan motor	CONT	PLANAR board
X1	Relay	PIO	Display board

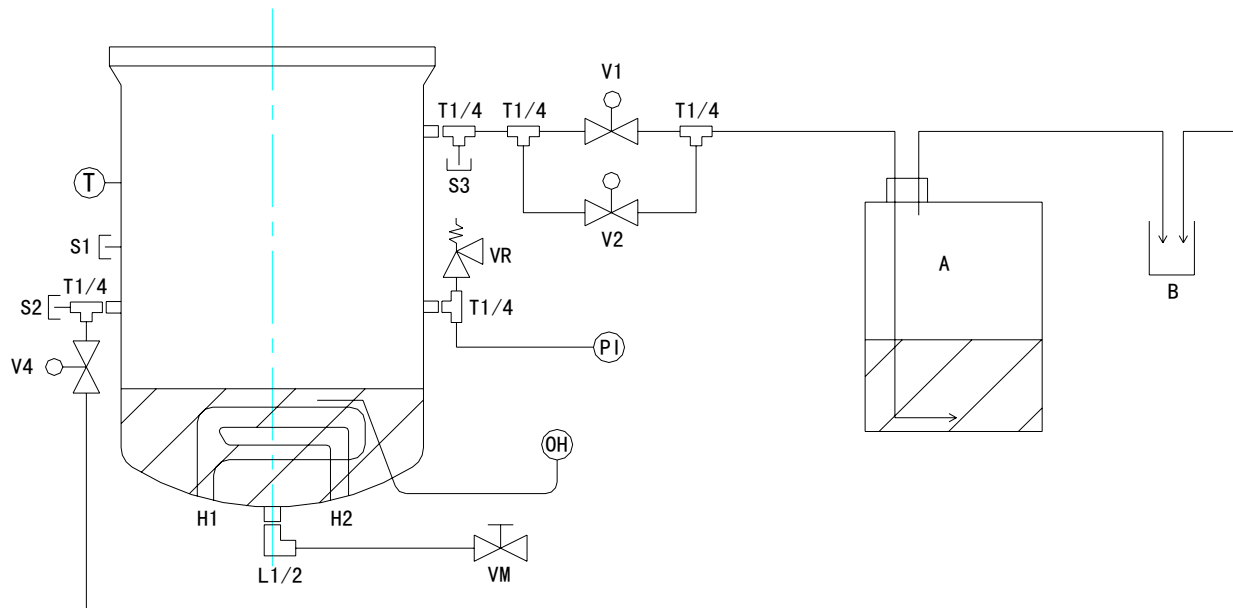

Symbol	Part name	Symbol	Part name
T	Sensor for chamber	A	Drain bottle
OH	Thermostat (for water level detection)	B	Vapor cup
PI	Pressure gauge	S1	Option port (for sample sensor)
V1	Solenoid valve (full open)	S2	Option port (for sample sensor)
V2	Solenoid valve (slow exhaust)	S3	Option port (for sensor for recorder)
VR	Safety valve	H1, 2	Heater
V3	Drain valve (manual)	V4	Solenoid valve (full open)

## Replacement Parts Table

### Common parts

Symbol	Part Name	Code No.	Specification	Manufacturer
CONT	PLANAR board	LT00013584	SN/SQ type	Yamato Scientific
PIO	Display board	LT00013585	SN/SQ type	Yamato Scientific
X1	Relay	A011001001	HF116F-2/24VDC	Yamato Scientific
T1	Terminal block	A011301013	HD320-6PH	Yamato Scientific
ELB	Earth leakage breaker	A010414001	KD-L2123 30A 30mA	Yamato Scientific
CT	Current sensor	2170010002	CTL-6-S-400	URD
V1, 4	Solenoid valve	LT00014585	VCS41-5G-7-02-X32	SMC
V2	Solenoid valve	LT00014586	VCS21-5G-2-02-X32	SMC
V3	DC solenoid	12080400010	TDS-12SB/DC24V	Yamato Scientific
FM	Fan motor	A080104007	SJ1238HD2BAL	Yamato Scientific
OH	Thermostat	LT00014599	EGO 55.13042.110	E.G.O
BSW LCSW LKSW	Micro switch	LT00002990	D2VW-01L3-1M	OMRON
Pt	Sensor for chamber	LT00014592	Pt100Ω	Yamato Scientific
-	Safety valve	LT00014593	M3D-B (setting: 0.255MPa)	Mihana Seisakusho
-	Pressure gauge	A042300006	GS58-271 (range: 0.4MPa)	Nagano Keiki
-	Drain bottle			Yamato Scientific
-	Exhaust hose			Yamato Scientific
-	Bottle plug			Yamato Scientific
-	Silencer			Yamato Scientific
-	Vapor cup			Yamato Scientific
-	Lock lever			Yamato Scientific
-	Hook			Yamato Scientific
-	Hook axis			Yamato Scientific
-	Compressed spring			Yamato Scientific
-	Compression spring			Yamato Scientific
-	Slow leak piping ASSY			Yamato Scientific

# Replacement Parts Table

## For SN200C/210C

Symbol	Part Name		Code No.	Specification	Manufacturer
H1	Heater 1		LT00014573	100V 600W outside	Yamato Scientific
H2	Heater 2		LT00014574	100V 600W inside	Yamato Scientific
SSR	Solid state relay	SN200C	A011006003	XBPE4050C DC24	Yamato Scientific
		SN210C	A011006011	G3NB-225B-1 DC5~24V	OMRON
DC	Switching power supply	SN200C	A010801005	HF60W-SF-24	Yamato Scientific
		SN210C	A010801004	HF-55W-S-24	
-	Packing		LT00014630		Yamato Scientific
-	Spring (left)		LT00014622		Yamato Scientific
-	Spring (right)		LT00014623		Yamato Scientific

## For SN300C/310C

Symbol	Part Name		Code No.	Specification	Manufacturer
H1	Heater 1		LT00014692	100V 800W outside	Yamato Scientific
H2	Heater 2		LT00014693	100V 800W inside	Yamato Scientific
SSR	Solid state relay	SN300C	A011006003	XBPE4050C DC24	Yamato Scientific
		SN310C	A011006011	G3NB-225B-1 DC5~24V	OMRON
DC	Switching power supply	SN300C	A010801005	HF60W-SF-24	Yamato Scientific
		SN310C	A010801004	HF-55W-S-24	
-	Packing		LT00014716		Yamato Scientific
-	Spring (left)		LT00014707		Yamato Scientific
-	Spring (right)		LT00014708		Yamato Scientific



## Replacement Parts Table

### For SN500C/510C

Symbol	Part Name		Code No.	Specification	Manufacturer
H1	Heater 1		LT00014802	100V 950W outside	Yamato Scientific
H2	Heater 2		LT00014803	100V 950W inside	Yamato Scientific
SSR	Solid state relay	SN500C	A011006003	XBPE4050C DC24	Yamato Scientific
		SN510C	A011006011	G3NB-225B-1 DC5~24V	OMRON
DC	Switching power supply	SN500C	A010801005	HF60W-SF-24	Yamato Scientific
		SN510C	A010801004	HF-55W-S-24	
-	Packing		LT00014716		Yamato Scientific
-	Spring (left)		LT00014707		Yamato Scientific
-	Spring (right)		LT00014708		Yamato Scientific

### For SQ500C/510C/800C/810C

Symbol	Part Name		Code No.	Specification	Manufacturer
H1	Heater 1		LT00014834	100V 1000W outside	Yamato Scientific
H2	Heater 2		LT00014835	100V 1000W inside	Yamato Scientific
SSR	Solid state relay	SQ500C	A011006003	XBPE4050C DC24	Yamato Scientific
		SQ510C	A011006011	G3NB-225B-1 DC5~24V	OMRON
DC	Switching power supply	SQ800C	A010801005	HF60W-SF-24	Yamato Scientific
		SQ810C	A010801004	HF-55W-S-24	
-	Packing		LT00014859		Yamato Scientific
-	Spring (left)		LT00014853		Yamato Scientific
-	Spring (right)		LT00014854		Yamato Scientific

## List of Dangerous Substances



Never use explosive substances, flammable substances and substances that include explosive or flammable ingredients in this unit.

### EXPLOSIVE

<b>EXPLOSIVE:</b>	Ethylene glycol dinitrate (nitro glycol), Glycerin trinitrate (nitroglycerine), Cellulose nitrate (nitrocellulose), and other explosive nitrate esters
	Trinitrobenzene, Trinitrotoluene, Trinitrophenol (picric acid), and other explosive nitro compounds
	Acetyl hidroperoxide (peracetic acid), Methyl ethyl ketone peroxide, Benzyl peroxide, and other organic peroxides

### FLAMMABLE

<b>IGNITING:</b>	Lithium (metal), Potassium (metal), Sodium (metal), Yellow phosphorus, Phosphorus sulfide, Red phosphorus, Celluloid compounds, Calcium carbide, Lime phosphate, Magnesium (powder), Aluminum (powder), Powder of metals other than magnesium and aluminum, Sodium hydrosulfite
<b>OXIDIZING:</b>	Potassium chlorate, Sodium chlorate, Ammonium chlorate, and other chlorate
	Potassium perchlorate, Sodium perchlorate, Ammonium perchlorate, and other perchlorate
	Potassium peroxide, Sodium peroxide, Barium peroxide, and other inorganic peroxide
	Potassium nitrate, Sodium nitrate, Ammonium nitrate, and other nitrate
	Sodium chlorite and other chlorites
<b>INFLAMMABLE LIQUID:</b>	Calcium hypochlorite and other hypochlorites
	Ethyl ether, Gasoline, Acetaldehyde, Propylene chloride, Carbon disulfide, and other flammable substances having a flash point of lower than -30°C
	Normal hexane, ethylene oxide, acetone, benzene, methyl ethyl ketone, and other flammable substances having a flash point of -30°C or higher but lower than 0°C
	Methanol, Ethanol, Xylene, Pentyl acetate (amyl acetate), and other flammable substances having a flash point of 0°C or higher but lower than 30°C
<b>FLAMMABLE GAS:</b>	Kerosene, Light oil (gas oil), Oil of turpentine, Isopentyl alcohol (isoamyl alcohol), Acetic acid, and other flammable substances having a flash point of 30°C or higher but lower than 65°C
	Hydrogen, Acetylene, Ethylene, Methane, Propane, Butane, and other flammable substances which assume a gaseous state at 15°C and 1 atm

(Source: Appendix Table 1 of Article 6 of the Industrial Safety and Health Order in Japan)

# Installation Standard Manual

\* Install the unit according the procedure described below (check options and special specifications separately).

Model	Serial number	Date	Person in charge of installation (company name)	Person in charge of installation	Judgment

No.	Item	Method	Reference operation manual	Judgment
<b>Specifications</b>				
1	Accessories	Check the quantities of accessories with the quantities shown in the Accessory column.	<b>Specification</b>	P.49
2	Installation	<ul style="list-style-type: none"> <li>• Visually check the surrounding area. Note: Pay attention to the ambient environment.</li> </ul>	<b>Before Using This Unit</b> "1. Choose a proper place for installation"	P.6
		<ul style="list-style-type: none"> <li>• Keep space.</li> </ul>		
		<ul style="list-style-type: none"> <li>• Measure the customer-specific voltage (switchboard and outlet) with the tester.</li> </ul>	<b>Before Using This Unit</b> "7. Choose a correct power distribution board or receptacle"	P.8
		<ul style="list-style-type: none"> <li>• Measure the voltage at operation (it must be within the range of standard). Note: Use the on-spec product when installed on the plug or breaker.</li> </ul>	<b>Before Using This Unit</b> "9. Always ground this unit"	P.9
			<b>Specification</b>	P.49
		<ul style="list-style-type: none"> <li>• Clean the packing and flange on the chamber.</li> </ul>	<b>Handling Precautions</b> "Do not damage the packing on the cover or flange on the chamber"	P.42
	<ul style="list-style-type: none"> <li>• Attach the drain bottle. Note: Supply water into the bottle.</li> </ul>	<b>Before Using This Unit</b> "Installation Procedure"	P.10	
<ul style="list-style-type: none"> <li>• Attach the drain board.</li> </ul>				
<ul style="list-style-type: none"> <li>• Close the drain valve.</li> </ul>				
<ul style="list-style-type: none"> <li>• Supply water into the chamber. Note: Supply water to the gauge level on the drain board.</li> </ul>				
	<ul style="list-style-type: none"> <li>• Attach the vapor cup and droplet tray.</li> </ul>			
<b>Operation</b>				
1	Test operation	<ul style="list-style-type: none"> <li>• Start operation. Operate the equipment with the apparatus sterilization course. Check: pressure/temperature rise, Vapor leak is not allowed.</li> </ul>	<b>Operation Method</b> "Apparatus/Liquid Sterilization Course"	P. 27
<b>Description</b>				
1	Description of operation	Explain the operation of each unit to the customer according to this Operation Manual.	<b>All</b>	
2	Error code	Explain error codes and the procedure for resetting them to the customer according to this Operation Manual.	<b>In the Event of Failure...</b>	P.45
3	Maintenance inspection	Explain the operation of each unit to the customer according to this Operation Manual.	<b>Maintenance Method</b>	P.43
4	Completion of installation Information to be entered	<ul style="list-style-type: none"> <li>• Enter the date of installation and the name of the person in charge of installation on the face plate on the unit.</li> <li>• Enter necessary information on the guarantee, and pass it to the customer.</li> <li>• Explain the after-sale service route to the customer.</li> </ul>	<b>After Service and Warranty</b>	P. 48

## Responsibility

Please follow the instructions in this document when using this unit. Yamato Scientific has no responsibility for the accidents or breakdown of device if it is used with a failure to comply. Never conduct what this document forbids. Unexpected accidents or breakdown may result in.

## Note

- ◆ The contents of this document may be changed in future without notice.
- ◆ Any books with missing pages or disorderly binding may be replaced.

Instruction Manual for

### **Sterilizer**

**Model SN200C/210C/300C/310C/500C/510C, SQ500C/510C/800C/810C**

Second Edition 02 FEB. 2012

Revision 26 Jun. 2015

---

Yamato Scientific America, Inc.  
925 Walsh Ave, Santa Clara, CA 95050  
Tel:408-235-7725  
For technical information  
and service call: 1-800-292-6286  
<http://www.yamato-usa.com>