

Yamato

Shaker

Model MK161

Instruction Manual

First Edition

- Thank you very much for purchasing this Yamato MK161 Shaker.
- Please read the “Operating Instructions” and “Warranty” before operating this unit to assure proper operation. After reading these documents, be sure to store them securely together with the “Warranty” at a handy place for future reference.

 **Warning:** Before operating the unit, be sure to read carefully and fully understand important warnings in the operating instructions.

**Yamato Scientific America Inc.
Santa Clara, CA**

1. Safety precautions	1
Explanation of pictograms	1
List of symbols	2
Warning • Cautions	3
2. Before operating the unit	4
Precautions on installation	4
3. Names of Parts	7
Main unit	7
Operation panel	8
4. Operating Procedures	9
Performing continuous shaking operation	9
Performing shaking operation using the timer.....	10
Performing shaking operation using the timer.....	11
How to change the shaking system	11
4. Operating Procedures	12
Installing a special rack (optional)	12
5. Handling precautions	13
6. Maintenance procedures	14
Daily inspection/maintenance	14
7. When the unit is not to be used for a long time or when disposing	14
When the unit is not to be used for a long time or when disposing	14
Notes about disposition.....	14
8. When a trouble occurs	15
Countermeasures for malfunctions	15
If a malfunction is suspected.....	15
9. After sales service and warranty	16
When requesting a repair.....	16
10. specifications	16
11. Wiring Diagram	17
12. Replacement parts table	18
13. List of dangerous materials	19

About pictograms

A variety of pictograms are indicated in this operating instruction and on products for safe operation. Possible results from improper operation ignoring them are as follows.

Be sure to fully understand the descriptions below before proceeding to the text.

 **Warning** Indicates a situation which may result in death or serious injury (Note 1.)

 **Caution** Indicates a situation which may result in minor injury (Note 2) and property damages (Note 3.)

(Note 1) Serious injury means a wound, an electrical shock, a bone fracture or intoxication that may leave after effects or require hospitalization or outpatient visits for a long time.

(Note 2) Minor injury means a wound or an electrical shock that does not require hospitalization or outpatient visits for a long time.

(Note 3) Property damage means damage to facilities, devices and buildings or other properties.

Meanings of pictograms



This pictogram indicates a matter that encourages the user to adhere to warning ("caution" included).
Specific description of warning is indicated near this pictogram.



This pictogram indicates prohibitions
Specific prohibition is indicated near this pictogram.



This pictogram indicates matters that the user must perform
Specific instruction is indicated near this pictogram.

1. Safety precautions

List of symbols

Warning



General warnings

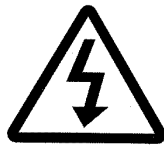

Danger!: High voltage



Danger!: High temperature



Danger!: Moving part

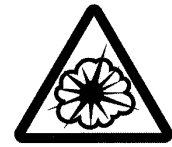

Danger!: Hazard of explosion

Caution



General cautions



Electrical shock!



Burning!



Caution for no liquid heating!



Caution for water leak!



For water only



Poisonous material

Prohibitions



General bans



Fire ban



Do not disassemble



Do not touch

Compulsions



General compulsions



Connect ground wire



Install levelly



Pull out the power plug



Regular inspection

1.Safety precautions

Warning · Cautions

Warning



Never operate the unit in an atmosphere containing flammable or explosive gas

Never operate the unit in an atmosphere containing flammable or explosive gas. Otherwise, an explosion or a fire may result since the unit is not explosion-proof. See page 19.



Be sure to connect the ground wire.

Be sure to connect the ground wire correctly. Otherwise, electrical leak may result and cause an electrical shock or a fire.



Ban on operation when an abnormality occurs

When a smoke or a unusual odor is seen or sensed, immediately turn the electric leakage breaker on the main unit off and pull out the power plug. A fire or an electrical shock may result.



Never use electrical power cords bundled.

When these are used bundled, they might overheat causing a fire.



Take care not to damage electrical power cords.

Avoid tightly bend, pull with a strong force or twist to prevent electrical power cords from damaging. A fire or an electrical shock may result.



Never use an explosive or a flammable material with this unit.

Never use an explosive material, a flammable material or a material containing them. Otherwise, an explosion or a fire may result.



Never try to disassemble or alter the unit.

Never try to disassemble or alter the unit. A malfunction, a fire or an electrical shock may result.



Caution



When a thunder is heard.

When a thunder is heard, turn the main power off immediately. A malfunction, fire or an electrical shock may result.

2. Before operating the unit

Precautions on installation



Warning

1. Be sure to connect the earth.



- Be sure to connect the earth wire (green core wire of the power cord) to the earth wire or the earth terminal to avoid an electrical shock due to earth leakage.
- Never connect the earth wire to a gas pipe or a water pipe. Otherwise, a fire may result.
- Never connect the earth wire to the earth terminal for a telephone line or to a lightning conductor. Otherwise, a fire or an electrical shock may result.
- Never use a branching outlet, which might generate heat and cause a danger.



We recommend use of a ground type outlet tap.

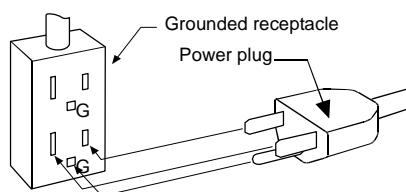

When there is no ground terminal.

In this case, type D grounding work is necessary and please consult your dealer or our nearest sales office.

When a bipolar type outlet tap is used

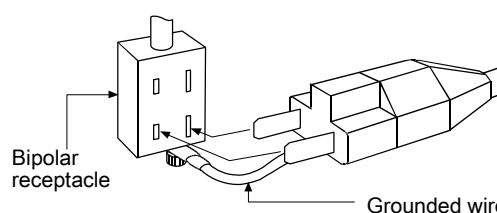

Insert the ground adaptor included as an option, into a power plug confirming the polarity of the outlet. Connect the grounding wire (green) of the ground adaptor to the ground terminal on the power supply equipment.

2. Carefully select an installation site.



Take special care not to install the unit at a place described below:

- Uneven surfaces or dirty surfaces
- Where flammable gas or corrosive gas exists
- Where the ambient temperature is 35 °C or more
- Where temperature changes severely
- Where humidity is high
- Where subject to direct sunlight
- Where vibration is severe



Install this unit at a place with spaces shown below.

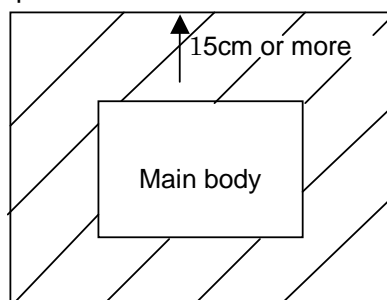

2. Before operating the unit

Precautions on installation

Warning

3. Never operate the unit in an atmosphere containing flammable or explosive gas.



Never operate the unit in an atmosphere containing flammable or explosive gas. Since the unit is not explosion-proof, an arc is discharged when switching "ON" and "OFF" and during operation and a fire or an explosion may result.

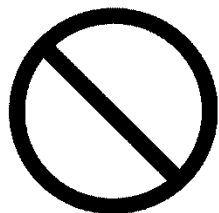

No explosive gas

No flammable gas

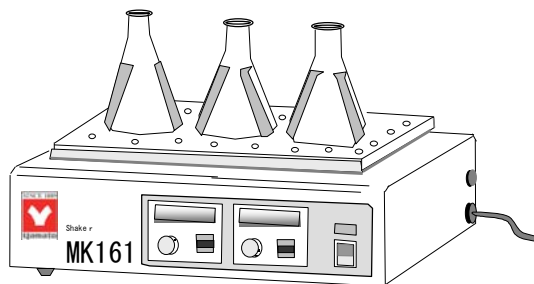

Note: Conical flasks and the shaking table are optional accessories.

4. Do not attempt to alter the unit



The customer shall never attempt to alter the unit. Otherwise a malfunction may result.



**No
modification**

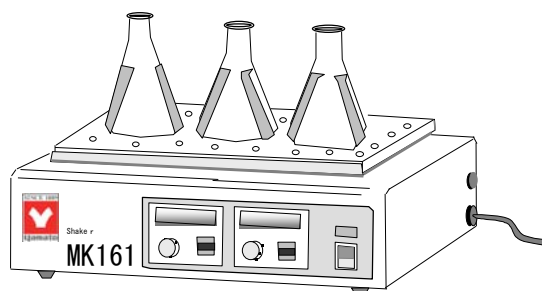

Note: Conical flasks and the shaking table are optional accessories.

5. Install the unit on a level surface



Place the unit on a place as level as possible. Vibrations or noises may be caused unless four rubber feet contact the floor surface evenly. Also, it might cause unexpected troubles or malfunctions.



**Uneven floor
forbidden
Install levelly**

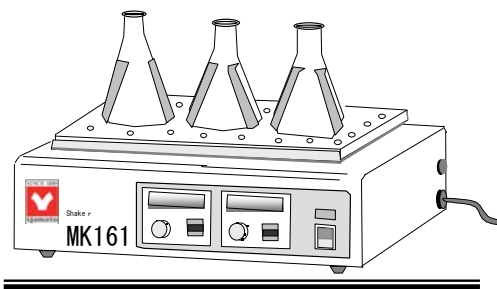

Note: Conical flasks and the shaking table are optional accessories.

2. Before operating the unit

Precautions on installation



6. Connect the power plug to the dedicated outlet

 Use an outlet that is suited to the electrical capacity.

Electrical capacity : AC115V 0.5A

* When the unit does not start even when power is turned ON, check if main voltage is too low or if the unit is connected to the same power line as other devices. If this is the case, use a different power line from those for other devices as the power supply.

7. On installation

 An earthquake or a shock may cause the unit fall over or move and personal injuries may result. We recommend exercising safety precautions including selecting an installation place where less people are passing by. Also, touching the shaking assembly during operation is dangerous. We recommend installing appropriate fence around the installation site.

8. About use in a constant temperature oven

 When you use the unit in a constant temperature oven at a constant temperature, keep the environmental temperature in the range from 5 °C to 35 °C. Do not use the unit in a humidified atmosphere.

9. Handling of a power cord

 Never use electrical power cords bundled. When these are used bundled, they might overheat causing a fire.

Do not convert, forcibly bend, twist or pull the power cord. Otherwise, a fire or an electrical shock may result.

Do not place the power cord under a desk or a chair, or sand between objects to avoid it from being damaged.

Otherwise, a fire or an electrical shock may result.

Do not place the power cord close to a stove or other heat generating device. Sheath of the cord may burn and result in a fire or an electrical shock.

 If the power cord should be damaged (exposure of core wire or disconnection), immediately turn the ELB off, pull out the power cord (plug) out of the power supply and ask your dealer to replace the cord. Operating the unit with a damaged power cord may cause a fire or an electrical shock.

 Connect the power cord to an appropriate wall outlet.

3. Names of Parts

Main unit

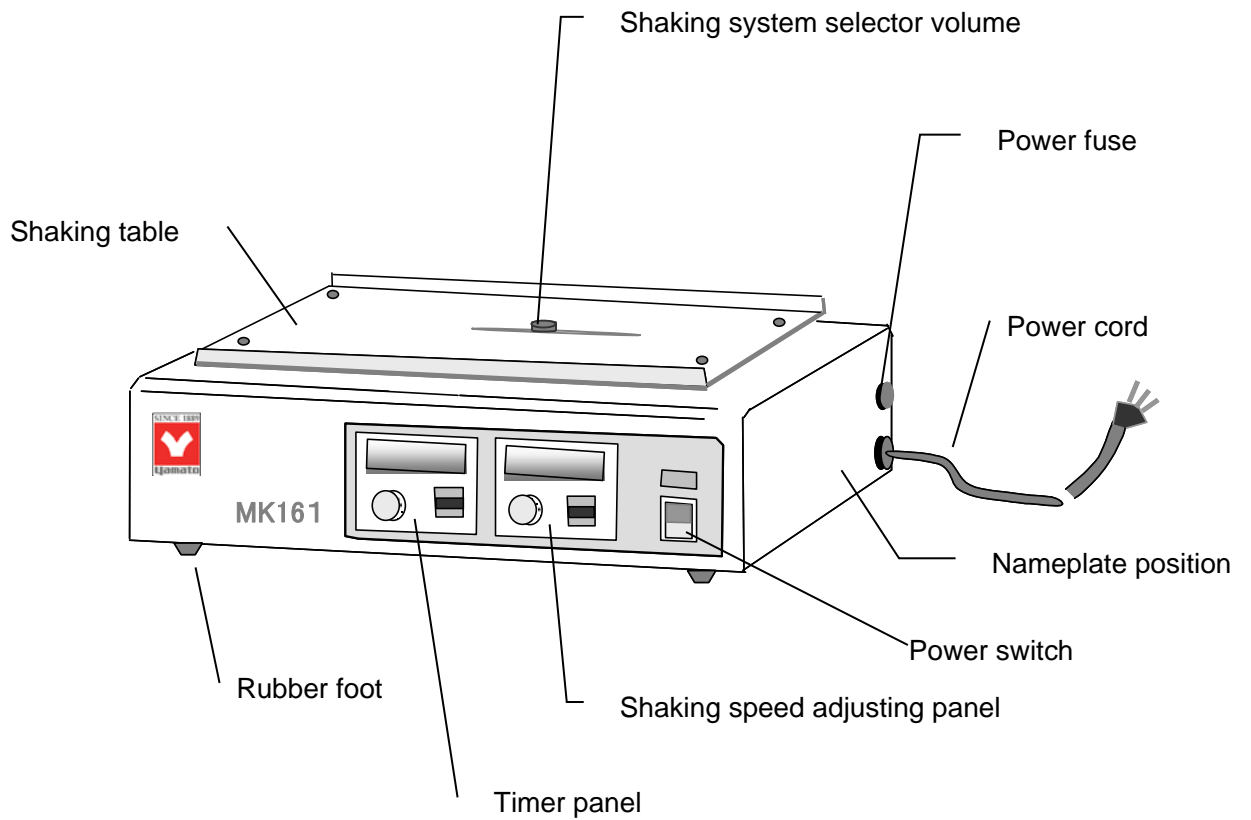

The unit requires a special rack (optional) dedicated for specific applications.
First purchase a special rack appropriate for your application referring to p.12.

3. Names of Parts

Operation panel

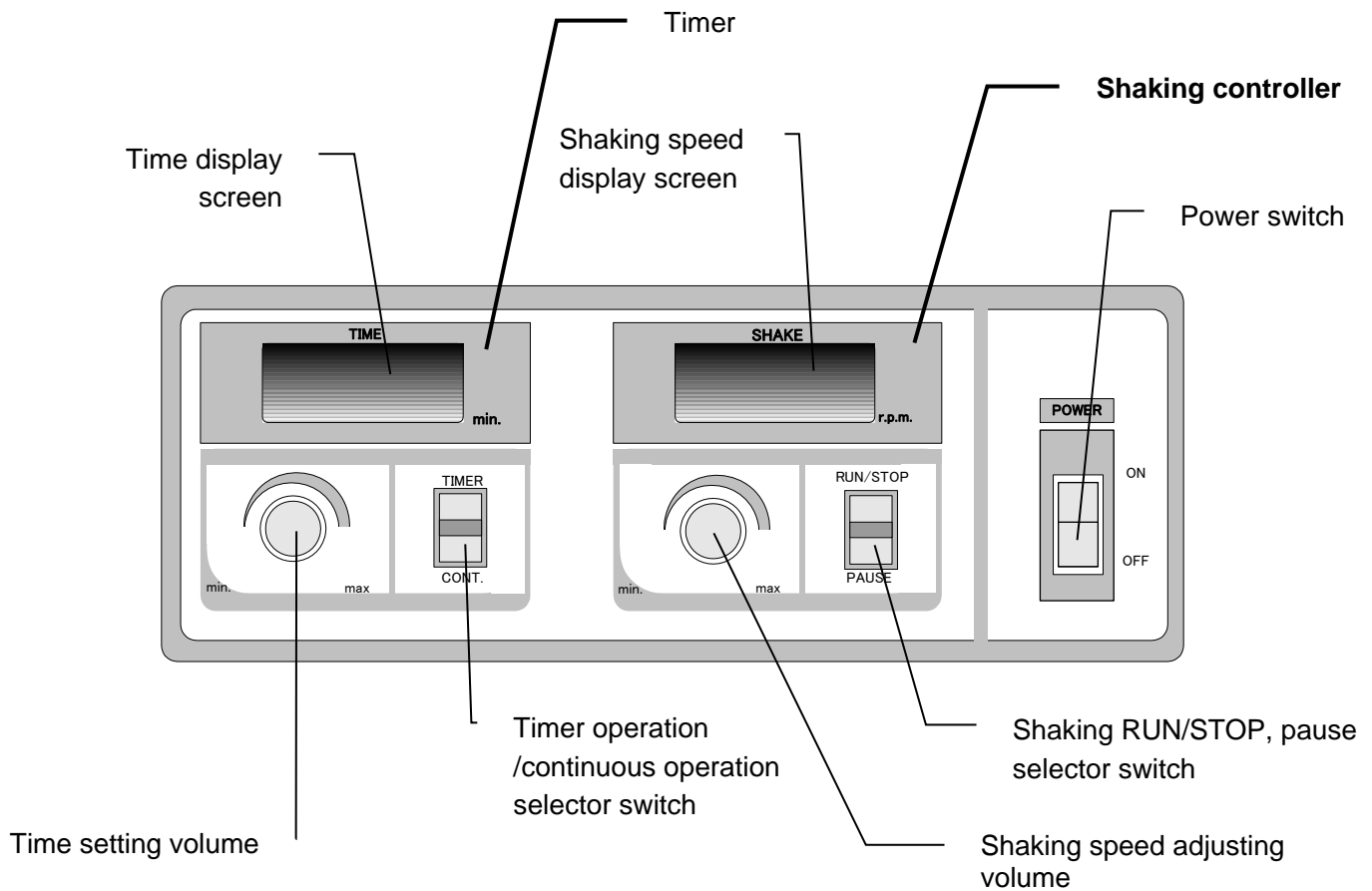

Shaking controller

1 Shaking speed display screen

The screen displays the set shaking speed and the current shaking speed.

2 Shaking speed adjusting volume

Turning this volume clockwise increases shaking speed. Turning it anticlockwise decreases shaking speed.

3 Shaking RUN/STOP/pause selector switch

Moving this switch upward starts shaking. Moving it downward stops shaking.

Moving this switch downward during timer operation pauses shaking. Move it upward to resume shaking.

Timer

1 Time display screen

The screen displays the set time and the remaining time.

2 Time setting volume

Turning this volume clockwise will increase the set time. Turning it anticlockwise will decrease the set time.

3 Timer operation/continuous operation selector switch

Moving this switch upward to enable timer setting.

Moving this switch downward to enable continuous operation.

4. Operating Procedures

Performing continuous shaking operation

How to perform shaking-only operation

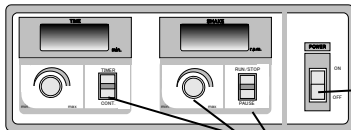
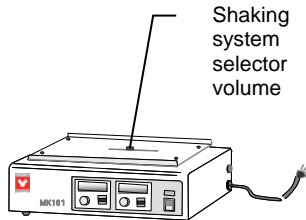

This section explains how to perform continuous shaking without using the timer function.

1. Selecting a shaking system

Set the shaking system selector volume to the system you want.
(See P.11.)

2. Setting specimen

Set specimen in the rack(s) specified for optional accessories. (See P.12.)

3. Turning power on (Turning the power switch ON)

Turn the power switch ON.

4. Setting a shaking speed

Set to a shaking speed you want by turning the speed adjusting volume clockwise.

Move the switch on the shaking speed adjusting panel to the RUN/STOP side.

Set the timer panel switch to [CONT.] side when you do not use the timer.

- ① Turn the power switch ON.
- ② Set this to the [CONT] side when you do not use the timer.
- ③ Set to a shaking speed you want with the volume.
- ④ Move the switch upward to RUN/STOP.

5. Starting operation

Setting the switch on the SHAKE panel to "RUN/STOP" side will start shaking. Initial shaking speed may not be obtained depending on the load status. Make fine adjustment with the shaking speed adjusting volume again during operation to set a number of shaking.

6. Stopping operation

Set the switch on the shaking speed adjusting panel to the [RUN/STOP] side.

7. Pausing shaking operation

Set the switch on the shaking speed adjusting panel to the [PAUSE] side. Shaking will pause. Setting this switch to the [RUN/STOP] side again to resume shaking.

About time setting	Timer setting time range is from 0 to 99.9 min. The minimum unit of time for setting is 0.1 min (6 seconds) .
About setting of shaking speed	<p>The maximum shaking speed is 200r.p.m (times/min) .</p> <p>Avoid setting to a speed higher than this, which causes severe vibration of the unit and poses a danger.</p> <p>When there is a difference between the set shaking speed and the indicated speed, make fine adjustment using the speed adjusting volume during shaking.</p>
About shaking stroke	The shaking stroke for this unit is fixed at 30mm.

4. Operating Procedures

Performing shaking operation using the timer

How to perform shaking operation using the timer

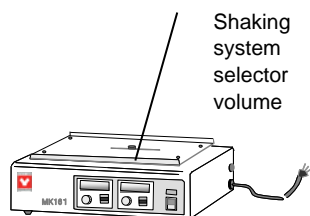

This section explains how to perform shaking operation using the timer function.

This operation mode is used to “perform shaking for the set time only”.

1. Selecting a shaking system

Set the shaking system selector volume to the system you want. (See P.11.)

2. Setting specimen

Set specimen in the rack(s) specified for optional accessories. (See P.12.)

3. Turning power on

Turn the power switch on the main unit ON.

4. Setting a timer

Set to a time you want using the time setting volume on the timer panel if you want to perform timer operation.

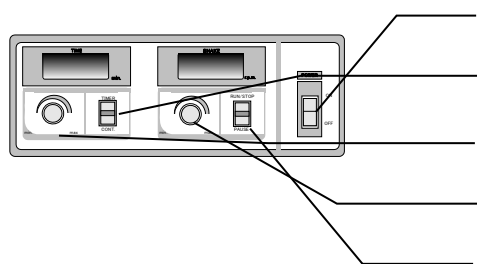

- ① Turn the power switch ON.
- ② Set the switch to the [TIMER] side.
- ③ Set a time you want using the volume.
- ④ Set to a shaking speed you want using the volume.
- ⑤ Move the switch upward to RUN/STOP.

5. Setting a shaking speed

Set to a shaking speed you want by turning the speed adjusting volume clockwise.

6. Starting shaking operation

Set the switch on the timer panel to the [TIMER] side. Move the switch on the shaking speed adjusting panel upward to the “RUN/STOP” side to start operation.

7. Pausing timer operation

Set the switch on the shaking speed adjusting panel to the [PAUSE] side. Shaking pauses.

Set the switch to the [RUN/STOP] side again to resume shaking for the remaining time.

8. Aborting timer operation

If you want to stop timer operation in the middle of it, set the switch on the shaking speed adjusting panel to the [RUN/STOP] side. Timer operation is cancelled.

9. Finishing timer operation

When timer operation finishes, the timer panel will indicate [00.0] and operation stops.

4. Operating Procedures

Performing shaking operation using the timer

About time setting	Timer setting time range is from 0 to 99.9 min. The minimum unit of time for setting is 0.1 min (6 seconds) . The timer volume may be turned either clockwise or anticlockwise for setting.
About setting of shaking speed	a The maximum shaking speed is 200r.p.m (times/min) . Avoid setting to a speed higher than this, which causes severe vibration of the unit and poses a danger.
About shaking stroke	The shaking stroke for this unit is fixed at 30mm.

When you want to change the shaking speed or the set time

You can change the shaking speed during operation simply by turning the volume on the shaking speed adjusting panel.
You cannot change the set time during timer operation. Stop timer operation first, and make setting again.

How to change the shaking system

The unit has employed a new system that allows selecting reciprocating, oval, or rotation shaking system only with a volume.

Move the volume along the mark indicated on the top of the main unit.

When you fix the volume in the midpoint between two marks, the system will perform an intermediate move between reciprocating and oval, or intermediate move between oval and rotation.

Shaking system selector volume

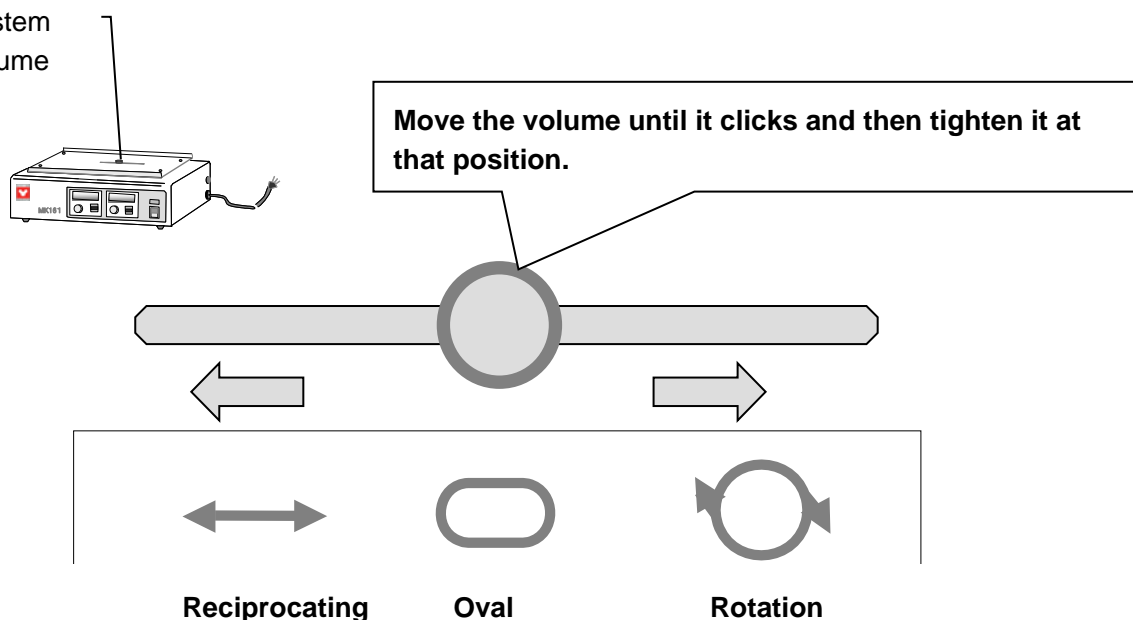

4. Operating Procedures

Installing a special rack (optional)

Special racks are available for the model MK161 (common with the model MK160).

Request them to the nearest dealer, one of our sales offices, or the general customer service center.

Product name	Product name	Capacity	Possible No. of units to install	No. of packages	Product code	
Clamp table Size : 290W × 250D				1 set	232061	
	Conical flask clamp	100ml conical flask	10	Set of 10	232062	
		200ml conical flask	9	Set of 9	232063	
		300ml conical flask*	5	Set of 5	232064	
		500ml conical flask*	4	Set of 4	232065	
		1000ml conical flask*	2	Set of 2	232066	
	*Springs of $\phi 65$ for holding conical flasks are included.					
	Shaking rack for slant type conical flask clamp	100ml conical flask	3 × 2 sets	1 set	232067	
		300ml conical flask*	2 × 2 sets	1 set	232068	
		500ml conical flask*	2 × 2 sets	1 set	232069	
*Springs of $\phi 65$ for holding conical flasks are included.						
Shaking rack for slant type spew tubes	15ml	12 × 2 sets	1 set	232070		
Shaking rack for slant type test tube	$\phi 12$ test tube	50 × 2 sets	1 set	232080		
	$\phi 16.5$ test tube	20 × 2 sets	1 set	232081		
	$\phi 18$ test tube	20 × 2 sets	1 set	232082		
Shaking rack for slant type 50ml centrifuge tube	$\phi 29$ centrifuge tube	18 × 2 sets	1 set	232083		
Non-slip sheet	290 × 250 × t1		1 sheet	232084		
Spring shaking table Size:290 × 250 × 66 Spring pitch:15mm No of net stage:1				1 set	232050	
2-stage spring shaking table Size:290 × 250 × 113 Spring pitch:15mm No of net stage:2				1 set	232056	

Note 1: The clamp installation table is not necessary when you use the spring shaking table or the 2-stage spring shaking table. These can be set directly onto the main unit.

Note 2: A separate clamp installation table will be necessary for conical flask claw clamps, slant type shaking racks, and non-slip sheets.

Note 3: Racks are common for MK161 and MK160.

5. Handling precautions

Warning

1. About materials that cannot be used

-  Never use an explosive material, a flammable material, or a material that contains such materials for this unit. They may cause an explosion or a fire. (See P.19 "List of dangerous materials".)

2. About banning of operation/solutions when an abnormality occurs

-  When smoke or strange odor is generated from this unit for some reason, immediate turn power of the unit off, shut the power supply off and ask inspection to your dealer, one of our sales offices, or the customer center. Leaving the unit as it is may cause a fire or an electrical shock. The user must not attempt a repair, which may cause a danger.

Caution

1. Putting specimen

-  Use the special rack to correctly put specimen. Put specimen evenly taking care not to be concentrated locally. The maximum total allowable weight is 5kg including racks and containers.

2. Do not climb on the unit

-  Do not climb on the unit. It may break and may lead to a personal injury or a malfunction.

3. Do not place any object on the unit

-  Do not place any object other than the special rack on the unit. The unit may malfunction or drop and cause a personal injury.

4. During a thunder storm

-  When a thunder begins, immediately turn power of the unit off, shut the power supply off. Leaving the unit as it is might cause a malfunction or a fire from lightning.

5. About speed adjustment

-  The unit has been adjusted to the appropriate speed at the time of factory shipping. The speed might change due to changes in source voltage or heating of the motor. When you notice abnormal vibrations or dislocation of the unit and other troubles, decrease the speed.
Take care not to exceed the specified maximum speed to avoid possible noises or malfunctions.

6. About operations

-  Always follow the operating procedures specified in the operation manual. Performing any operations other than those listed in this manual may cause a malfunction or an accident. Note that the product warranty may be void if you perform any operations other than those listed in this manual.

7. If a power failure occurs

-  The timer count will return to "00.0" after recovery from a power failure and shaking will stop at the current settings.

8. Handling process samples

-  Always handle process samples so they do not overflow or spill onto unit. Damage or failure may result. In the event of an overflow or spill, turn off the power and operate only after sample fluid has been sufficiently wiped from unit.

6. Maintenance procedures

Daily inspection/maintenance

Warning

- Be sure to pull out the power cord unless necessary before trying to do inspection and maintenance works.
- Never try to disassemble the unit.

Caution

- Wipe off any dirt with a tightly wrung soft cloth. Never try to clean the unit with benzene, thinner or scouring powder, or rub with a scrubbing brush. Deformation, degradation or discoloration may result.

7. When the unit is not to be used for a long time or when disposing

When the unit is not to be used for a long time or when disposing

Caution

When the unit is not going to be used for a long time

- Turn the power to off and pull out the power cord.

Warning

When disposing the unit

- Do not leave the unit in the area where children may have access.
- Be sure to remove handles before disposing the unit to prevent the doors from locking.
- In general, dispose the unit as a bulky waste.

Notes about disposition

Always pay attention to the preservation of the global environment.

- We highly recommend taking the unit apart as far as possible for separation or recycling to contribute to the preservation of the global environment. Major components and materials for the unit are as follows:

Names of major components	Major materials
Major components	
Chassis	Steel sheet iron, melamine resin baking finish
Nameplates	Polyethylene (PET) resin film
Major parts of shaker	
Shaking table	Stainless steel plate
Major electric parts of shaker	
Motor	Motor case, rotor, shaft: made of iron, bracket: made of aluminium, coil: copper (insulation coating with resin)
Power cord & wiring materials, etc.	Wiring materials and boards with resin cladding

8. When a trouble occurs

Countermeasures for malfunctions

Symptom	Causes	Countermeasures
Even if the switch is turned on <ul style="list-style-type: none"> ▪ No display appears ▪ Shaking does not start 	① Imperfect contact of a circuit ② Defect of the power switch ③ Fuse has blown ④ Defective substrate or imperfect contact	① Replace or repair ② Replace ③ Replace ④ Replace or repair
Although shaking is made <ul style="list-style-type: none"> ▪ It is not smoothly. ▪ Excessive noises or vibrations 	① Roller is worn ② Belt is loosened ③ Belt is worn or damaged ④ Anti-vibration rubber is defective ⑤ Floor is not flat	① Replace ② Adjust belt tension ③ Replace ④ Replace ⑤ Move to a different site
Speed is uncontrollable	① Speed controller is defective ② Motor is defective	① Replace ② Replace

If a malfunction is suspected

In such cases

Symptom	Check
The unit will not operate even though power is turned on.	<ul style="list-style-type: none"> ● If the power cord is connected to an outlet securely. ● If a power failure has occurred. ● If the fuse has blown.
Shaking speed fluctuates during operation.	<ul style="list-style-type: none"> ● If the amount of specimen is too much. ● If specimen is concentrated to one side. ● If source voltage is too low.
Shaking stops.	<ul style="list-style-type: none"> ● If the shaking table is not overloaded. ● If a foreign object is pinched in the shaking table.

- ◆ If the symptom does not fall on any of the categories above, immediately turn the power switch off, turn the source power off and contact your dealer, one of our sales office, or our general customer service center.

9. After sales service and warranty

When requesting a repair

When requesting a repair

If any trouble occurs, immediately stop operation, turn the power switch off, pull out the power plug and contact your dealer, our sales office or our customer service center.

Information necessary for requesting a repair

- Model name of the product
 - Serial number
 - Date (y/m/d) of purchase
 - Description of trouble (as in detail as possible)
- } See the warranty card or the nameplate on the unit.

Be sure to indicate the warranty card to our service representative.

Warranty card (attached separately)

- Warranty card is given by your dealer or one of our sales offices and please fill in your dealer, date of purchase and other information and send it to our customer service center by Facsimile (03-3231-6523). Then, store it securely.
- Warranty period is one full year from the date of purchase. Repair service for free is available according to the conditions written on the warranty card.
- For repairs after the warranty period consult your dealer, one of our sales offices or our customer service center.
Paid repair service is available on your request when the product's functionality can be maintained by repair.

Minimum holding period of repair parts

The minimum holding period of repair parts for this product is seven years after end of production. Repair parts here refer to parts necessary for maintaining performance of the product.

10. specifications

Model	MK161	
Specifications		
Shaking system	Reciprocating⇔oval⇔rotation serial switching (manual switch)	
Rotation shake stroke	Rotation shake stroke	30mm
	Reciprocating shake stroke	30mm
	Number of shakes	20~200/min
	Shaking number adjuster	Dial/digital display
Timer	Dial/digital display Digital 0.1min (6 sec) ~99.9min	
Safety unit	Motor protective circuit	
	Power fuse 2A	
Shaking table dimension	Main shaking table dimension:300W × 254D Additional shaking table dimension:290W × 250D	
Motor	DC brushless motor	
Max load weight	5kg (including racks and containers)	
Outer dimension	350W × 300D × 150H	
Weight	Approx.15kg	
Power supply	AC115V 50/60Hz—0.5A	
Accessories	Power fuse, operation manual, warranty card	

11.Wiring Diagram

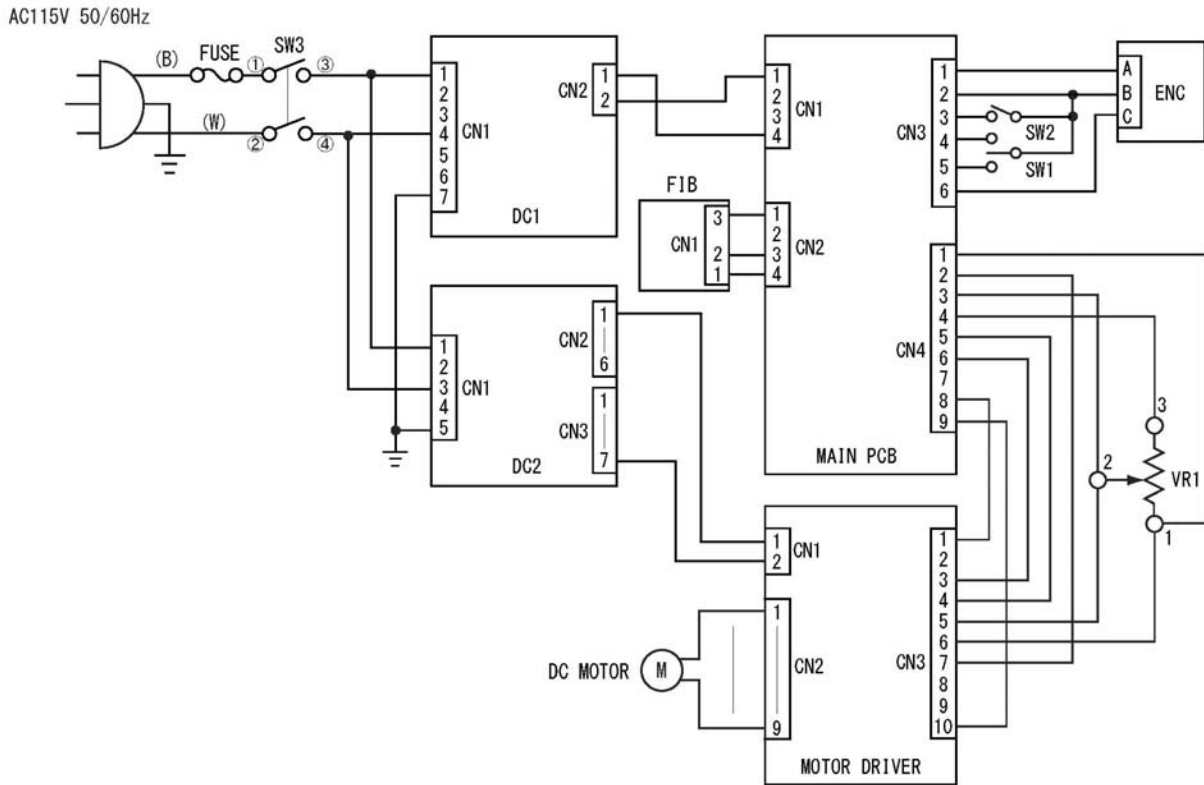

Symbol	Part name
FUSE	Power fuse
SW1	Shaking switch
SW2	Timer switch
SW3	Main switch
VR1	Shaking speed adjusting volume
M	DC motor
MAIN PCB	Control substrate
MOTER DRIVER	DC motor control substrate
DC1	DC power supply for control substrate
DC2	DC power supply for motor
ENC	Timer encoder
FIB	Rotation detection substrate

12. Replacement parts table

Replacement parts for MK161

Part name	Code No.	Specifications	Maker
Power cord	LT00001745	0.75Sq 1.8m with a 3P plug	Yamato
Power fuse	A0080015	F-7161 125V 2A	Sato Parts
Fuse holder	LT00021126	F400-01A1	Sato Parts
Main switch	LT00036046	AJ8200BF	Panasonic
DC power supply for control substrate	LT00002477	LCA10S-5	COSEL
DC power supply for motor	LT00021127	LCA150S-24	COSEL
DC motor	LT00019539	FY8S15-D3	NIDEC SERVO
DC motor control substrate	LT00019540	FYD815SD3	NIDEC SERVO
Control substrate	LT00002479	MK161	Yamato
Shaking switch	LT00002482	M-2028J	Nikkai
Timer switch	LT00002483	M-2022J	Nikkai
Bezel	LT00021128	AT-207K	Nikkai
Switch lever	LT00020352	AT-4136K	Nikkai
Interrupter substrate	LT00021135	MK161 interrupter substrate	Yamato
Encoder substrate	LT00021136	MK161 encoder substrate	Yamato
Roller bearing	LT00020355	DU-30-B5	TOK BB
V belt	LT00020356	MB-270	Mitsuhoshi

13. List of dangerous materials



Never use an explosive substance a flammable substance or a substance containing them for this device.

Explosive substance	Explosive substance	① Nitroglycol, glycerine trinitrate, cellulose nitrate and other explosive nitrate esters
		② Trinitrobenzen, trinitrotoluene, picric acid and other explosive nitro compounds
		③ Acetyl hydroperoxide, methyl ethyl ketone peroxide, benzoyl peroxide and other organic peroxides
Flammable substances	Explosive substances	Metal “lithium”, metal “potassium”, metal “natrium”, yellow phosphorus, phosphorus sulfide, red phosphorus, celluloids, calcium carbide (a.k.a, carbide), lime phosphide, magnesium powder, aluminum powder, metal powder other than magnesium and aluminum powder, sodium dithionous acid (a.k.a., hydrosulphite)
	Oxidizing substances	① Potassium chlorate, sodium chlorate, ammonium chlorate, and other chlorates
		② Potassium perchlorate, sodium perchlorate, ammonium perchlorate, and other perchlorates
		③ Potassium peroxide, sodium peroxide, barium peroxide, and other inorganic peroxides
		④ Potassium nitrate, sodium nitrate, ammonium nitrate, and other nitrates
		⑤ Sodium chlorite and other chlorites
		⑥ Calcium hypochlorite and other hypochlorites
	Flammable substances	① Ethyl ether, gasoline, acetaldehyde, propylene chloride, carbon disulfide, and other substances with ignition point at a degree 30 or more degrees below zero.
		② n-hexane, ethylene oxide, acetone, benzene, methyl ethyl ketone and other substances with ignition point between 30 degrees below zero and less than zero.
		③ Methanol, ethanol, xylene, pentyl acetate, (a.k.a.amyl acetate) and other substances with ignition point between zero and less than 30 degrees.
		④ Kerosene, light oil, terebinth oil, isopentyl alcohol(a.k.a. isoamyl alcohol), acetic acid and other substances with ignition point between 30 degrees and less than 65 degrees.
	Combustible gas	Hydrogen, acetylene, ethylene, methane, ethane, propane, butane and other Substance which is a flammable gas at 15°C, one air pressure.

(Quoted from the separate table 1 in Article 6, the enforcement order of the Industrial Safety and Health Law

Limited liability

Be sure to use the unit strictly following the handling and operating instructions in this operating instruction.

Yamato Scientific Co.,Ltd. assumes no responsibility for an accident or a malfunction caused by use of this product in any way not specified in this operating instruction.

Never attempt to perform matters prohibited in this operation instruction.

Otherwise, an unexpected accident may result.

Notice

- Descriptions in this operating instruction are subject to change without notice.
- We will replace a manual with a missing page or paging disorder.

Instruction Manual

Shaker

MK161

First edition March 22, 2017

Revised

Yamato Scientific America, Inc.

**925 Walsh Avenue, Santa Clara,
CA 95050, U.S.A**

<http://www.yamato-usa.com>

Toll Free: 1-800-2-YAMATO(1-800-292-6286)