

Yamato

Eco Incubator

Model INE800

First edition

- Thank you very much for purchasing this Yamato eco incubator INE800.
- Please read the “Operating Instructions” and “Warranty” before operating this unit to assure proper operation. After reading these documents, be sure to store them securely together with the “Warranty” at a handy place for future reference.

 **Warning:** Before operating the unit, be sure to read carefully and fully understand important warnings in the operating instructions.

Yamato Scientific Co., Ltd.

1. Safety precautions	1
Explanation of pictograms.....	1
List of symbols	2
Warning · Cautions	3
2. Before operating the unit	4
How to install and preparation before operation	4
Cautions for operation.....	7
About defrosting of the refrigerator	8
3. Names and functions of each part	10
Main unit.....	10
Structure of the main unit.....	11
Operation panel.....	12
4. Operating procedures	13
Initial setting to clock setting	13
Setting a buzzer sound pattern	14
Setting the refrigerator mode	15
Setting auto defrost.....	16
Operating procedures	17
Fixed temperature operation.....	18
Auto stop operation	20
Auto start operation.....	22
Program operation	24
How to input a program.....	26
Manual defrost	30
Setting the key lock mode.....	30
Setting the recovery mode	31
Setting a calibration offset.....	32
Backup setting.....	33
To view indications on the monitor	34
Setting the temperature output terminal	35
Setting external communication.....	36
Setting time-up output (optional).....	57
Setting external alarm output (optional).....	57
About the standalone overheat preventive device.....	58
5. Handling precautions	59
6. Maintenance procedures	60
Daily inspection/maintenance	60
7. When the unit is not to be used for a long time or when disposing	62
When the unit is not to be used for a long time or when disposing.....	62
Notes about disposition.....	62
8. When a trouble occurs	63
Safety device and error codes	63
Troubleshooting.....	64
9. After sales service and warranty	65
When requesting a repair.....	65
10. Specifications	66
11. Wiring Diagram	67
12. List of replacement parts	69
13. List of dangerous materials	70
14. Standard installation manual	71

1. Safety precautions

Explanation of pictograms

About pictograms

A variety of pictograms are indicated in this operating instruction and on products for safe operation. Possible results from improper operation ignoring them are as follows.

Be sure to fully understand the descriptions below before proceeding to the text.

 **Warning** Indicates a situation which may result in death or serious injury (Note 1.)

 **Caution** Indicates a situation which may result in minor injury (Note 2) and property damages (Note 3.)

(Note 1) Serious injury means a wound, an electrical shock, a bone fracture or intoxication that may leave after effects or require hospitalization or outpatient visits for a long time.

(Note 2) Minor injury means a wound or an electrical shock that does not require hospitalization or outpatient visits for a long time.

(Note 3) Property damage means damage to facilities, devices and buildings or other properties.

Meanings of pictograms



This pictogram indicates a matter that encourages the user to adhere to warning ("caution" included).
Specific description of warning is indicated near this pictogram.



This pictogram indicates prohibitions
Specific prohibition is indicated near this pictogram.



This pictogram indicates matters that the user must perform
Specific instruction is indicated near this pictogram.

1. Safety precautions

List of symbols

Warning



General warnings



Danger!: High voltage



Danger!: High temperature



Danger!: Moving part



Danger!: Hazard of explosion

Caution



General cautions



Electrical shock!



Burning!



Caution for no liquid heating!



Caution for water leak!



For water only



Poisonous material

Prohibitions



General bans



Fire ban



Do not disassemble



Do not touch

Compulsions



General compulsions



Connect ground wire



Install levelly

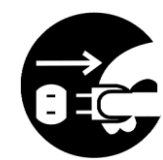

Pull out the power plug



Regular inspection

1.Safety precautions

Warning · Cautions

Warning



Never operate the unit in an atmosphere containing flammable or explosive gas

Never operate the unit in an atmosphere containing flammable or explosive gas. Otherwise, an explosion or a fire may result since the unit is not explosion-proof. See section “13 List of dangerous materials” on page 70



Be sure to connect the ground wire.

Be sure to connect the ground wire correctly. Otherwise, electrical leak may result and cause an electrical shock or a fire.



Ban on operation when an abnormality occurs

When a smoke or an unusual odor is seen or sensed, immediately turn the power off and pull out the power plug from the power distribution board. A fire or an electrical shock may result.



Never use electrical power cords bundled.

When these are used bundled, they might overheat causing a fire.



Take care not to damage electrical power cords.

Avoid tightly bend, pull with a strong force or twist to prevent electrical power cords from damaging. A fire or an electrical shock may result.



Never try to disassemble or alter the unit.

Never try to disassemble or alter the unit. A malfunction, a fire or an electrical shock may result.



Inhibition of octopus wiring.

Octopus wiring using a branching outlet or extensions using a cord reel may cause degradation of freezing performance or temperature control performance as well as heat generation or a fire from a voltage drop.



Never place the unit on its side

Never place the unit on its side during transportation or movement to avoid the malfunction of the refrigerator. If making the unit inclined is inevitable at carrying-in, leave the unit for about a day (for 24 hours) without turning the main power on after carrying-in has been completed.



Caution



When a thunder is heard.

When a thunder is heard, turn the main power off immediately. A malfunction, fire or an electrical shock may result.

2. Before operating the unit

How to install and preparation before operation



Warning

1. Be sure to connect the ground wire.



- Be sure to connect the earth wire (green core wire of the power cord) to the earth wire or the earth terminal to avoid an electrical shock due to earth leakage.
- Never connect the earth wire to a gas pipe or a water pipe. Otherwise, a fire may result.
- Never connect the earth wire to the earth terminal for a telephone line or to a lightning conductor. Otherwise, a fire or an electrical shock may result.
- Never use a branching outlet, which might generate heat and cause a danger.

We recommend use of a ground type outlet tap.

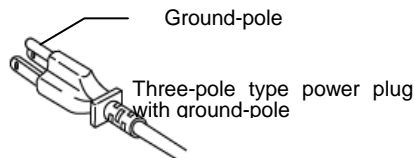

ground type outlet

When there is no ground terminal.

- In this case, class D grounding work is necessary and please consult your dealer or our customer service center.

When a bipolar type outlet tap is used

To two-pole type power supply 100V



Ground wire

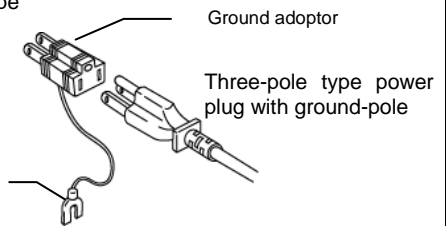

Ground adaptor

- Insert the ground adaptor into a power plug confirming the polarity of the outlet. Connect the grounding wire (green) of the ground adaptor to the ground terminal on the power supply equipment.

2. Carefully select an installation site.



- Take special care not to install the unit at a place described below:
 - Where flammable gas or corrosive gas exists
 - Where humidity is high
 - Where the ambient temperature is 35• °C or more
 - Where temperature changes severely
 - Where subject to direct sunlight
 - Where vibration is severe
 - Outdoor



Install this unit at a place with spaces shown below.

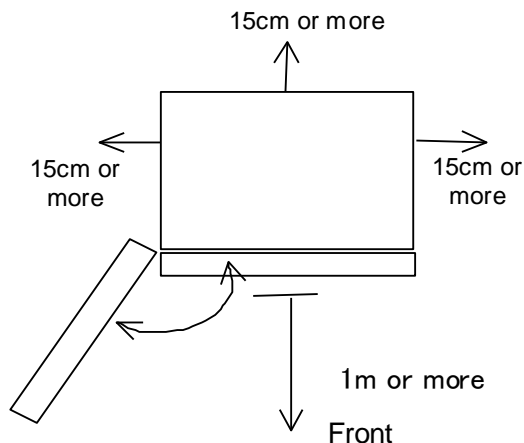

3. Precautions for defrosting.



Accept water at the drain hose during defrosting using a drain pan prepared in advance.

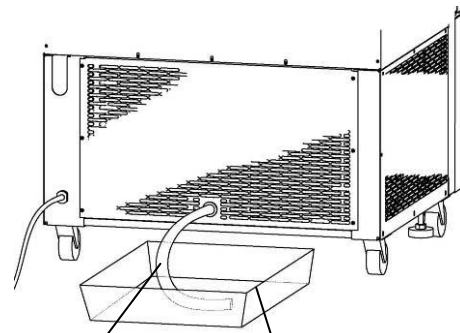

Note: Drain pan is not included in the product.

2. Before operating the unit

How to install and preparation before operation

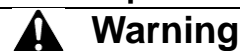

Warning

3. Never operate the unit in an atmosphere containing flammable or explosive gas.



- Never operate the unit in an atmosphere containing flammable or explosive gas. Since the unit is not explosion-proof, an arc is discharged when switching the ELB "ON" and "OFF" and during operation and a fire or an explosion may result.

See the section "13 List of dangerous materials" on page 70 for flammable and explosive gases.

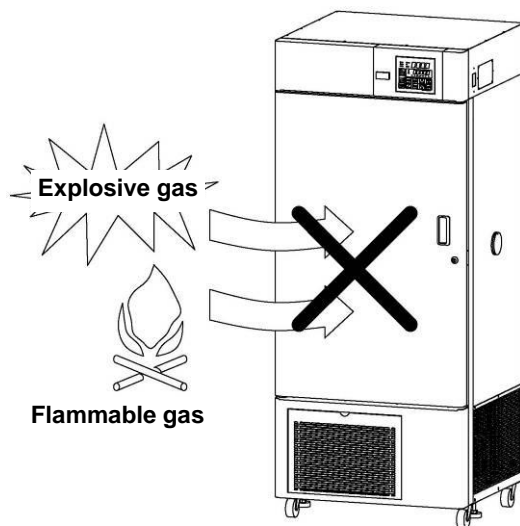

4. Do not attempt to alter the unit



- The customer shall never attempt to alter the unit. Otherwise a malfunction may result.

Modification

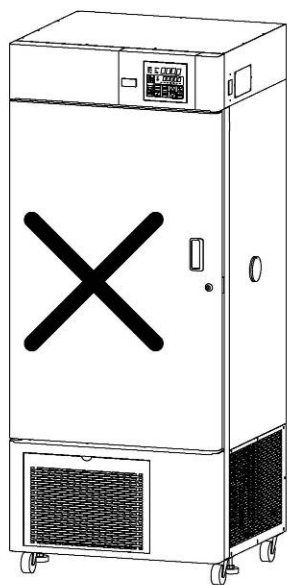

5. Install the unit on a level surface



- Install the unit on a level surface. Otherwise unexpected troubles or a malfunction may result.

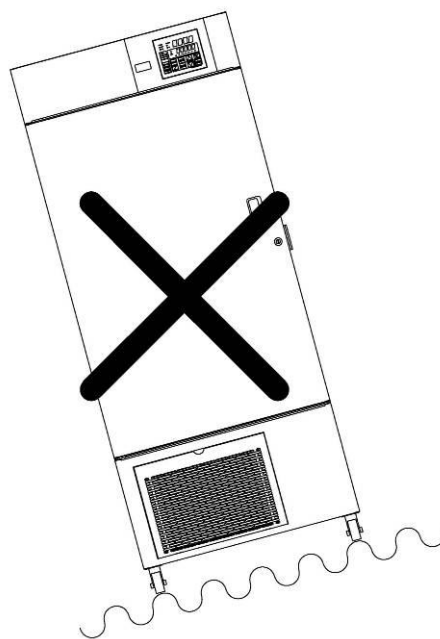

The unit weight is approx. 135 kg.

When lifting the unit for transportation and installation, carefully handle it by at least two people.

2. Before operating the unit

How to install and preparation before operation

6. Power supply

- Use a power supply that meets the electrical capacity of the unit.

Electrical capacity: : AC100V 10A (ELB capacity:15A)

Avoid connecting too many devices using a branching outlet or extending a wire with a cord reel or refrigerating function and temperature controlling function may degrade due to voltage drop and heat generation or a fire may occur.

7. Handling of a power cord

- Never use electrical power cords bundled. When these are used bundled, they might overheat causing a fire.
- Do not convert, forcibly bend, twist or pull the power cord. Otherwise, a fire or an electrical shock may result.
- Do not place the power cord under a desk or a chair, or sand between objects to avoid it from being damaged. Otherwise, a fire or an electrical shock may result.
- Do not place the power cord close to a stove or other heat-generating device. Sheath of the cord may burn and result in a fire or an electrical shock.
- If the power cord should be damaged (exposure of core wire or disconnection), immediately turn the ELB off, turn the power supply off and ask your dealer to replace the cord. If the unit is operated with a damaged power cord, a fire or an electrical shock may result.
- Connect the power cord to an appropriate wall outlet.

8. Installation

- The unit might fall down or move by an earthquake or an impact resulting a personal injury. We recommend making safety measures such as to avoid installing the unit at a place other than busy places.

9. About fixing the adjusters

- There are adjusters at two positions on the front of the main unit.

When the installation site has been determined, follow the procedures below to fix the adjusters.

- ① Turn the adjusters until they securely sit on the floor.
- ② Check for gaps at four points on the installation points on the main body.
- ③ Turn the nuts to securely fix the adjusters under the bottom surface to prevent loosening.

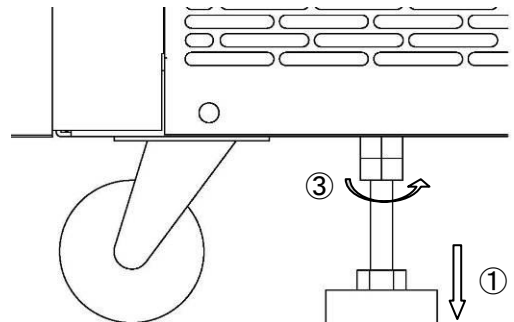

10. After installation

- The unit may topple down in an earthquake or an unexpected impact and cause personal injuries. Take appropriate topple-down preventive measures for safety.

2. Before operating the unit.

Cautions for operation

Warning

1. Specimen that must not be used.

- ⊘ This unit is not explosion-proof. Never attempt to dry or process a specimen that contains a flammable or explosive component.

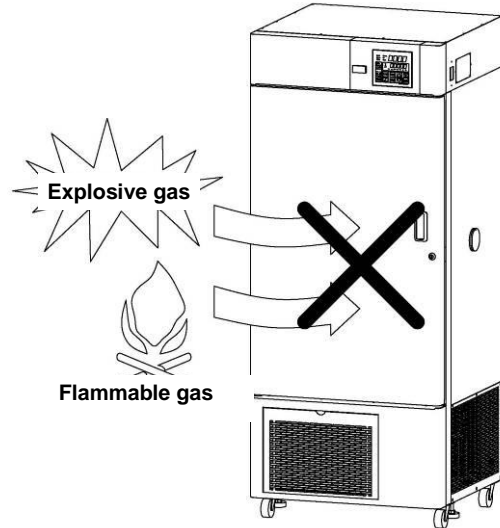

Cautions

2. Put specimens dispersed.

- ! The withstand load of a shelf board is 15 kg when the load is evenly distributed. Put specimens dispersed.

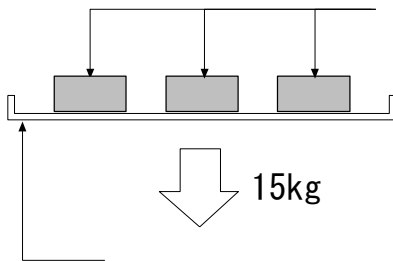

3. Secure space

- ! Too many specimens will prevent correct temperature control. In order to assure temperature precision, be sure to use shelf boards and put specimens dispersed, and secure at least 30% of space inside the bath.

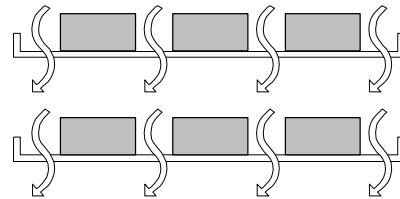

4. Take extreme care for specimens below !

Corrosive specimens

- ! Although the unit employs stainless steel plates for its internal surface, take care that they might corrode with strong acids. Also, take care that vinyl chloride rubber packing may corrode from acid or alkaline substances, oils or organic solvents.
- ! The evaporator, when a lot of frost is formed on it, may degrade the freezing capacity and the set temperature may not be maintained. In particular, take care for specimens that contain more moisture will form more frost on the evaporator. If frosting is found through the frost observation window, start defrost operation.
- ! You cannot use a device with a larger heat burden that increases temperature in the unit.

2. Before operating the unit

About defrosting of the refrigerator

When a lot of frost is formed on the evaporator of the refrigerator, the freezing capacity may be degraded and the set temperature may not be maintained. The unit allows frosting on the evaporator through the frost observation window at the back of the unit. The rate of frosting will differ depending on the following conditions.

- (1) Operating temperature ... Operating at a lower temperature tends to form more frost.
- (2) External temperature and humidity ... Higher external temperature and humidity tend to form more frost.
- (3) State of specimen in the unit ... More moisture in the specimen tends to form more frost.

The unit allows the following operation modes to prevent frosting, one of which shall be set according to the operating status. The operation modes can be enabled both during the fixed temperature and the program operations by pressing the defrost key on the controller operation panel separately from the fixed temperature operation or the program operation.

- 1 Manual defrost operation (starting of operation is manual and stopping is auto)
When a lot of frost is formed, start defrost operation. While defrosting operation is started manually, the operation will automatically stop with the internal timer after about five minutes.
→See page 30 for operating procedures.

- 2 Automatic defrosting operation (both starting and stopping of operation are automatic)
It is effective for long-term operation of the unit to set the cycle defrost that performs defrosting at the preset time cycle, or time defrosting that performs defrosting at the specified time every day. Once you have set the defrosting operation and the time to stop, you can repeat start and stop defrosting operation automatically at the set intervals. In ordinary cases, you can remove frost by performing defrosting operation for about five minutes a day. However, select an appropriate setting based on the actual status of frosting, which will defer depending on the actual operating conditions.
→See page 16 for operating procedures.

Caution

- Although it depends on the operating conditions, take care for possible influences on specimen because the temperature in the unit will rise by about 3°C during a five-minute defrosting. And the temperature on the display may rise by 10°C or more in this case.

2. Before operating the unit

About defrosting of the refrigerator

3 Setting the refrigerator operation mode of the refrigerator (continuous & cycle)

The refrigerator operation mode is a function that enables continuous operation, cycle operation or stopping the refrigerator.

Continuous operation is used when temperature control precision is important. Note that frost tends to form the more the lower the temperature is at the set temperature range of 0~30°C.

Cycle operation controls by repeating the sequence: operation of the refrigerator (14 minutes)→ pause (six minutes) and has less temperature control precision compared with the continuous operation but is able to reduce frosting. Note that the refrigerator enters the continuous operation mode automatically because of the freezing capacity reasons when the set temperature is 10°C or lower. (When the refrigerator is set at Stop, it will not operate irrespective of the set temperature.)

Drying of specimen can be reduced by performing the cycle operation. Set the refrigerator to Stop if its operation is unnecessary. (The refrigerator will automatically set to stop irrespective of the select operation mode when the set temperature is 40.1°C or more.)

→See page 15 for operating procedures.

Caution

- Even when the cycle operation is set, forming of frost may gradually increase during a long time of operation depending on the operating conditions. When a lot of frost is formed, perform defrosting operation or cycle defrosting operation to remove frost. Be sure to put a drain pan to accept water of melted frost at the drain hose.

3. Names and functions of each part

Main unit

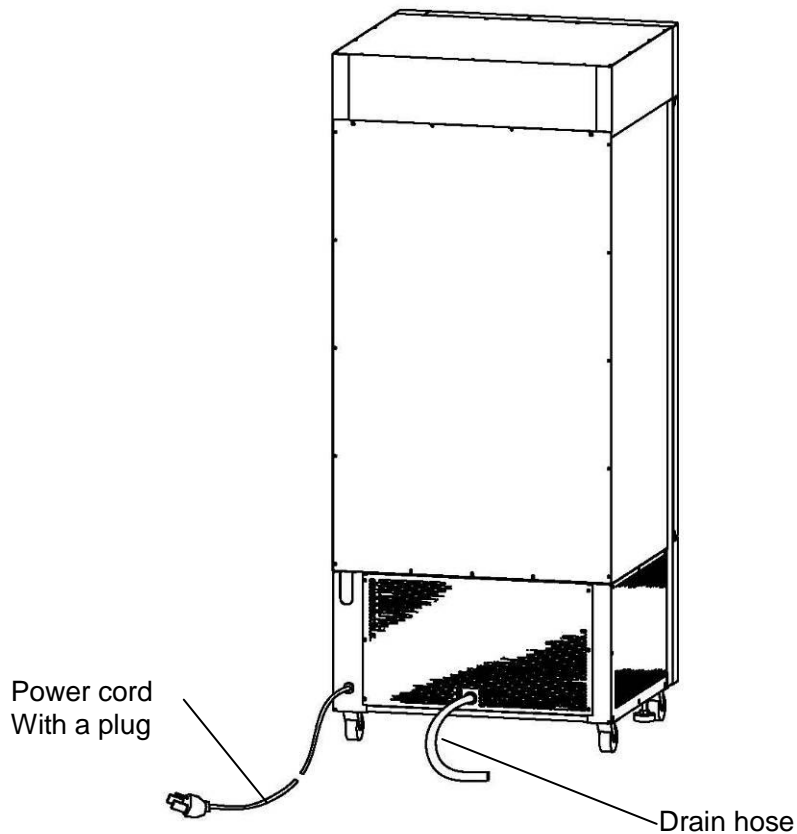
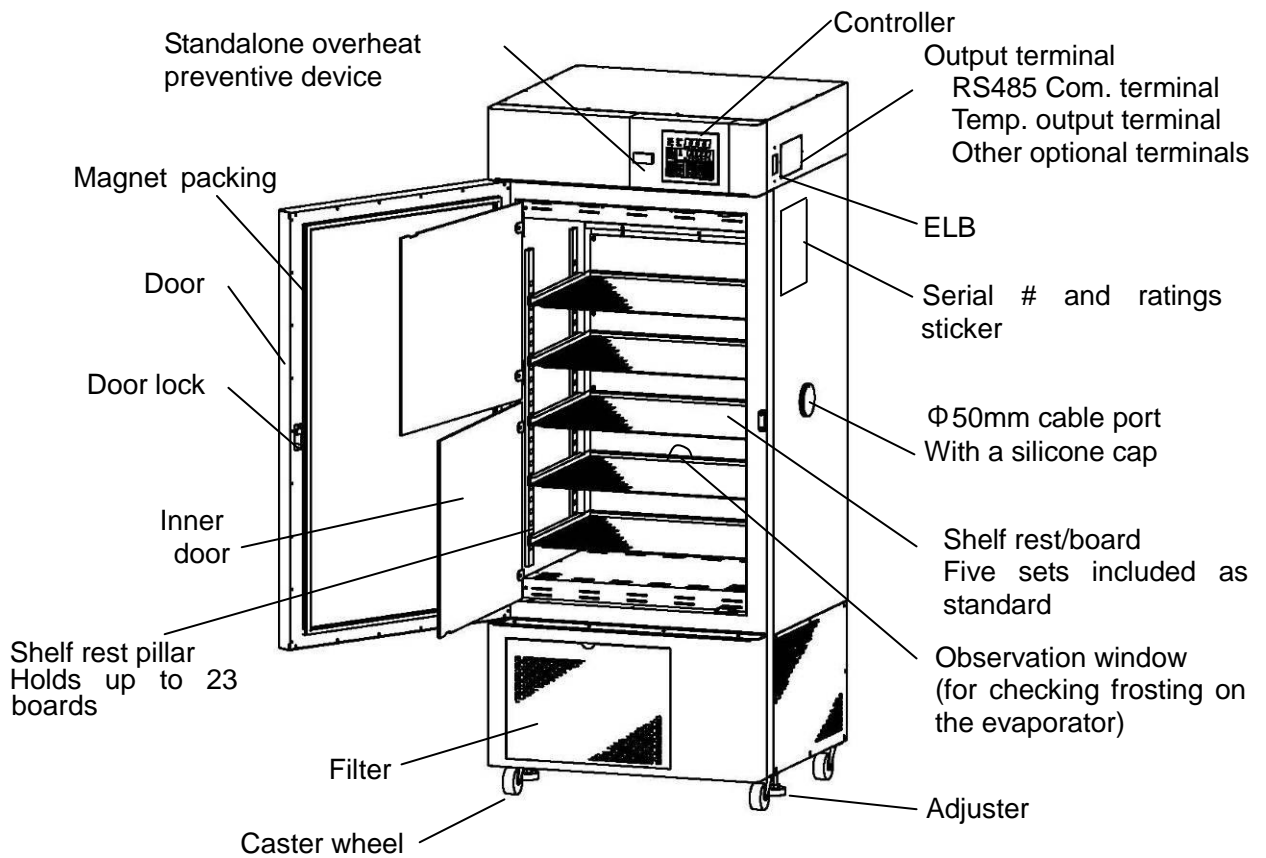

3. Names and functions of each part

Structure of the main unit

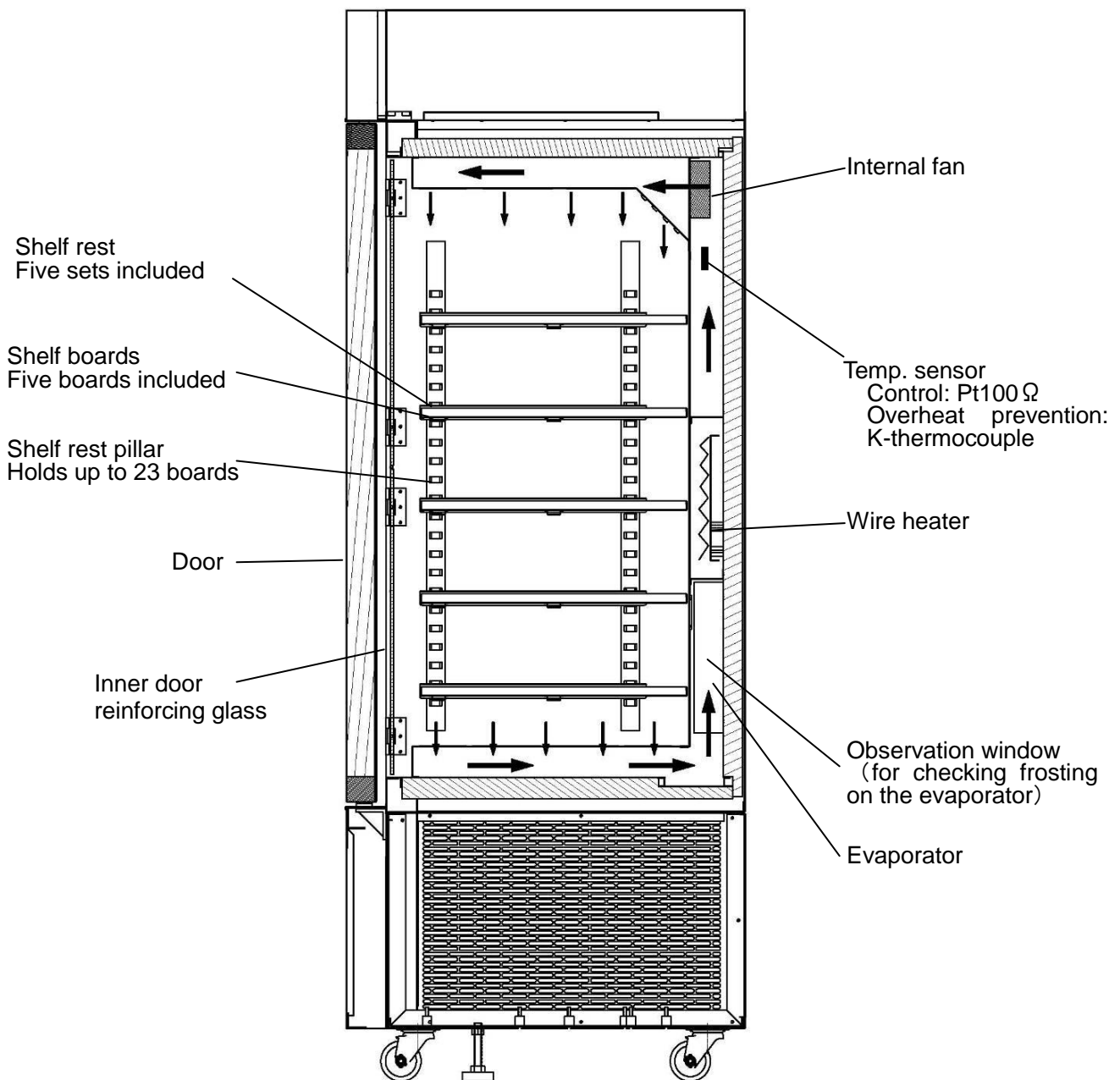

Air inside the unit will be suctioned at the rectifier board at the lower part in the unit with the internal fan and sent to the air conditioning assembly at the back.

The air conditioning assembly at the back has a refrigerator (evaporator of the refrigerator) and a heater, and air temperature will be controlled while the air flows through the air conditioning assembly and blow out at the upper rectifier board and circulates inside the unit.

The temperature controller controls the chiller and the heater in the air conditioning assembly based on the signals from the temperature sensor installed at the blowing-out part of the internal fan to adjust the temperature of the air circulating inside the unit.

The refrigerator (chiller) is controlled with an inverter and it implements energy-saving operation by automatically selecting an optimal cooling capacity according to the set temperature.

※The unit produces operating sounds different from our conventional products because of the introduction of an inverter. Operating sounds of the refrigerator will also change depending on the set temperature, which does not indicate any abnormalities.

33. Names and functions of each part

Operation panel

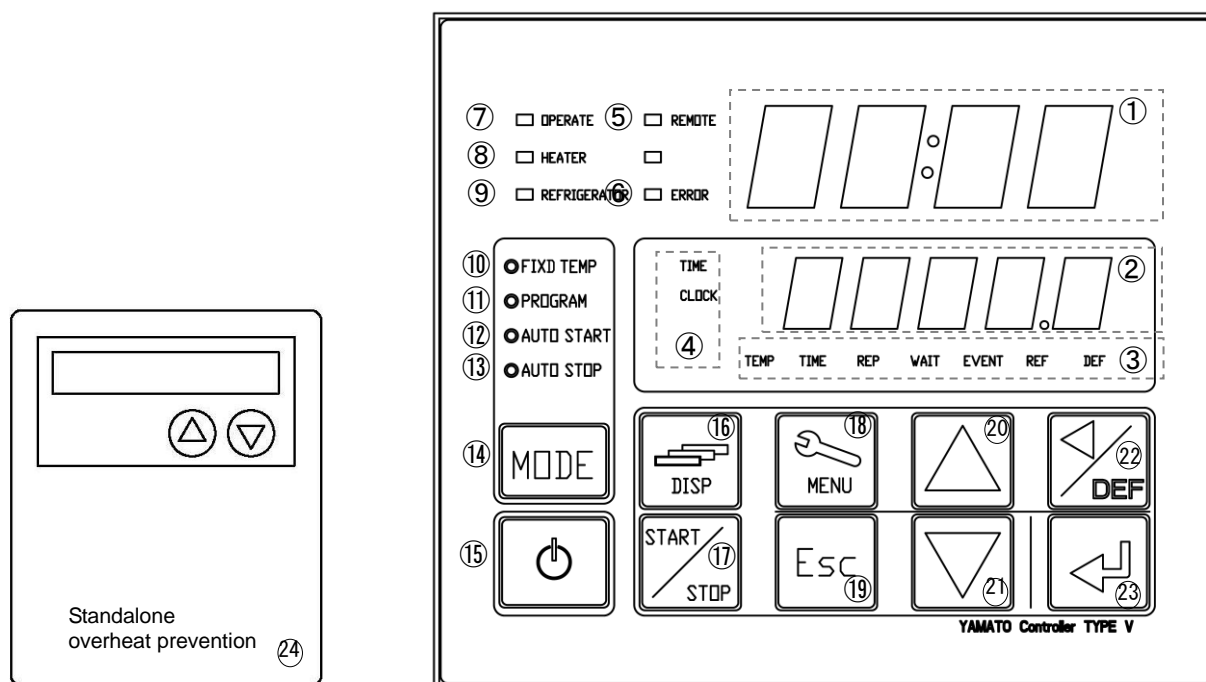

No	Name	Description
1	Main display	Displays the internal temperature and error numbers.
2	Sub display	Displays the set temperature and various pieces of information.
3	Setting guide display	Displays guides for various settings.
4	Setting guide display	Displays guides for various settings.
5	REMOTE lamp	Comes on during communication setting.
6	ERROR lamp	Comes on when an error occurs.
7	OPERATE lamp	Comes on during operation and flashes during operation standby mode.
8	HEATER lamp	Comes on while power is supplied to the heater.
9	REFRIGERATOR lamp	Comes on while power is supplied to the refrigerator and flashes while it is in the operation standby mode.
10	FIXED TEMP lamp	Comes on during fixed temperature operation.
11	PROGRAM lamp	Comes on during program operation and flashes while an operation mode is selected.
12	AUTO START lamp	Comes on during auto start and flashes while an operation mode is selected.
13	AUTO STOP lamp	Comes on during auto stop and flashes while an operation mode is selected.
14	MODE key	Used for switching operation modes among ⑩~⑬.
15	POWER key	Used to turning power On/Off by keeping this key pressed longer.
16	DISP key	Displays power consumption, discharged amount of CO ₂ by keeping this key pressed longer.
17	START/STOP key	Used for starting or stopping the unit.
18	MENU key	Used for setting programs, the buzzer sound, refrigerator modes, the automatic defrost or the temperature output terminal.
19	Esc key	Used when aborting editing or quitting a menu without entering settings or setting items.
20	▲(Up) key	Used for changing settings.
21	▼(Down) key	Used for changing settings.
22	◀ /DEF key	Used for moving the cursor to the left during setting or as the manual defrost key.
23	ENTER key	Used to enter settings or setting items.
24	Standalone overheat preventive device	Used for setting the standalone overheat preventive device.

4. Operating procedures

Initial setting to clock setting

The backup battery contained in the controller is a consumable part. Its rough service life is about five years but we recommend replacing it with a new one earlier.

※ Contact our service department for replacement of the batteries. Make a backup copy beforehand if a program is being used. See “Backup setting on Page 33.”

After replacing the batteries, set the clock correctly again to your watch or the time tone.

1 Turning power on

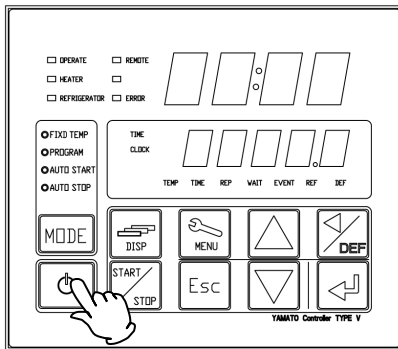

Turn the ELB at the upper part on the right side “ON”. The Sub display on the controller indicates the current time.

Keep the controller key pressed longer to turn the power on.

Main display indicates the internal temperature and the Sub display indicates the set temperature.

2 Display the screens for setting the year/month/day and time using the MENU key

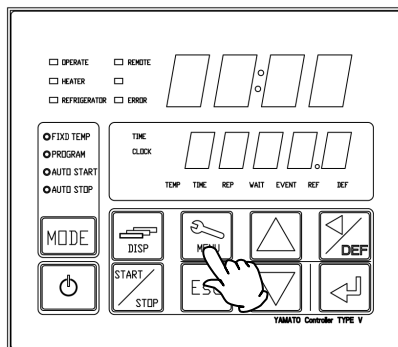

- ① Press the key.
- ② Press the key to move the item forward and press at the item **FUNC**.
- ③ When the item [bUZZ] appears, press the key to display the screen for setting the year/month/day.

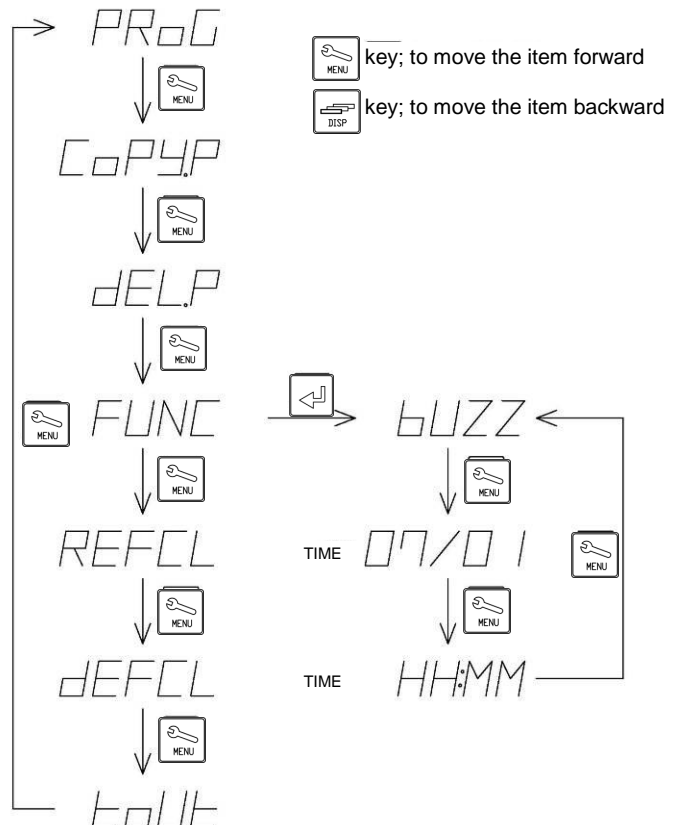

4. Operating procedures

Setting the clock

3 Setting the year and month/day

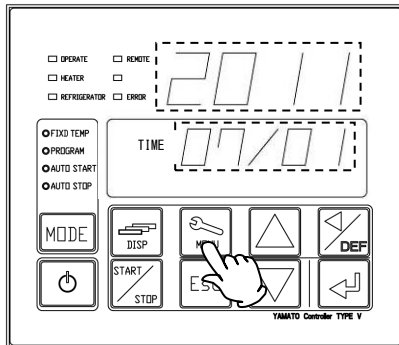

Follow the procedures below to set the date and the clock.

- ① The TIME lamp flashes and the screen for the year and month/date appears.
- ② Press the key.
- ③ Set the western calendar year using the ▲▼ keys and then press the key.
- ④ Set the month/day using the ▲▼ keys and then press the key.

※ You can move the setting position to the left using the ◀ key.

4 Setting the clock (24-hour format)

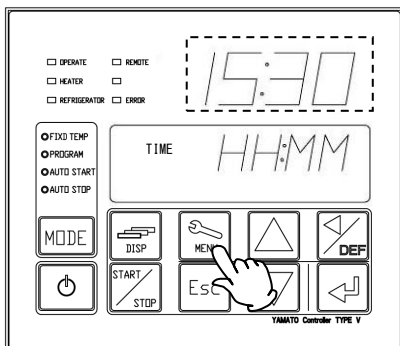

- ① Press the key.
 - ② Press the ENTER key, set the time using the ▲▼ keys and then decide on it using the key. Enter the time in the 24-hour format.
- ※ You can move the setting position to the left using the ◀ key.
- ③ After completing the setting, press the key twice to return to the initial screen.

Setting a buzzer sound pattern

1 Setting a buzzer sound pattern

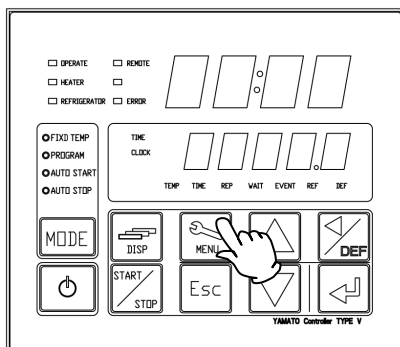

- ① As in the clock setting, use the and keys to display Sub display [bUZZ] in the Sub display and then press the key.
- ② Select from three buzzer sound patterns using the ▲▼ keys and decide on it with the key.

on: All operation sounds will be enabled (initial setting).

CLK: Click sound only is disabled.

(Sound of the POWER key or other determining operation is enabled)

off: Both click sound and determining operation sounds are disabled.

- ※ Buzzer sounds when an error occurs even if you set [bUZZ] to OFF.
- ③ After completing setting, press the key twice to return to the initial screen.

4. Operating procedures

Setting the refrigerator mode

1 Setting the refrigerator mode

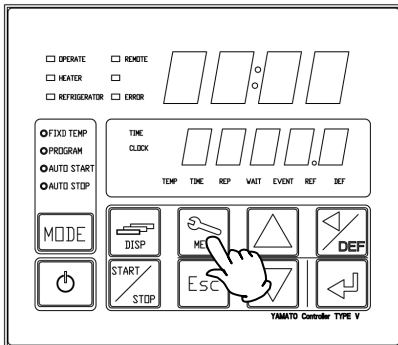

① Press the key several times until [REFCL] appears in the Sub display and then press the key.

② When [REF] appears in the Sub display, press the key, select a refrigerator mode from three options using the keys and then decide on it with the key.

Cnt: Continuous operation (setting: 0~40°C; it is turned OFF at 40.1°C or higher)

non: The refrigerator will be OFF at all setting temperatures.

CyC: Cycle operation (setting: 10.1 °C ~ 40 °C ; continuous operation will be active at 10°C or lower; the operation is turned OFF at 40.1°C or higher)

• Also check the settings below when you have selected[CyC]:

REF.o: Refrigerator ON time (initial value: 14 min.)

REF.F: Refrigerator OFF time(initial value:6 min.)

※Avoid changing the initial settings because these are recommended values.

③ After completing setting, press the key twice to return to the initial screen.

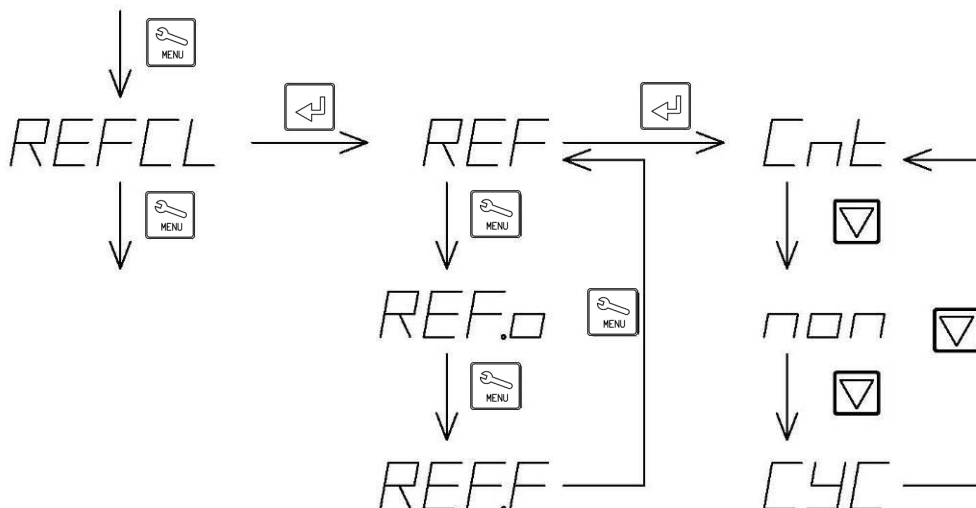

4. Operating procedures

Setting auto defrost

1 Setting auto defrost

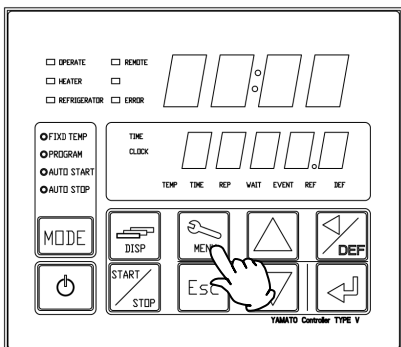

※ You cannot change the current auto defrost setting while the unit is in operation. First, stop operation before setting.

① Press the key several times until [dEFCL] appears in the Sub display and then press the key.

② When [A-dEF] appears in the Sub display, press the key and select an auto defrost mode from three patterns.

non : auto defrost OFF

tIME: cycle defrost (Required settings-dEF:Cy, dEF: t M)

CLK : Clock defrost (Required settings-dFS.t, dEF: t M)

dFS.t : Defrost time(initial value: 00 : 00)[TIME]

dEF:Cy: Ordinary run time (initial value:24hrs) [TIME]
Counted at the start of operation

dEF: t M: Defrost time(initial value:5min) [MIN]※

Example 1 Cycle defrost

A-dEF :tIME Every 12 hours after start of operation.

dEF:Cy:12 ⇒ Defrosting is performed for five minutes.

dEF:tM:5

Example 2 Clock defrost

A-dEF :CLK Defrosting is performed for five minutes once every day at 17 : 00.

dFS:t :17:00 ⇒

dEF:tM:5

※ When setting to a larger value, select a value taking possible increase in internal temperature into consideration. The margin of increase is about 3°C for five-minute defrosting, which differs depending on the internal set temperature or other conditions.

③ After completing setting, press the key twice to return to the initial screen.

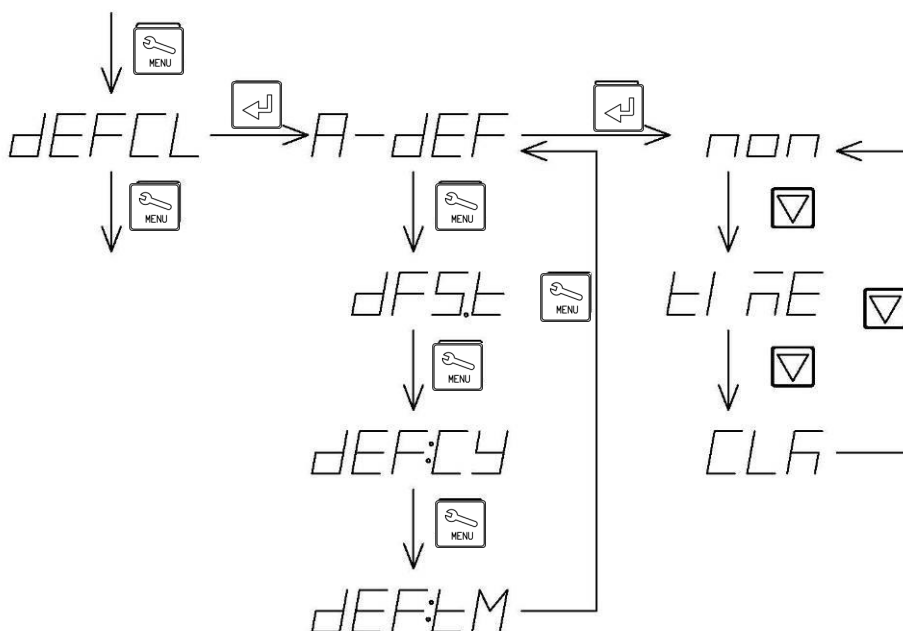

4. Operating procedures

Operating procedures

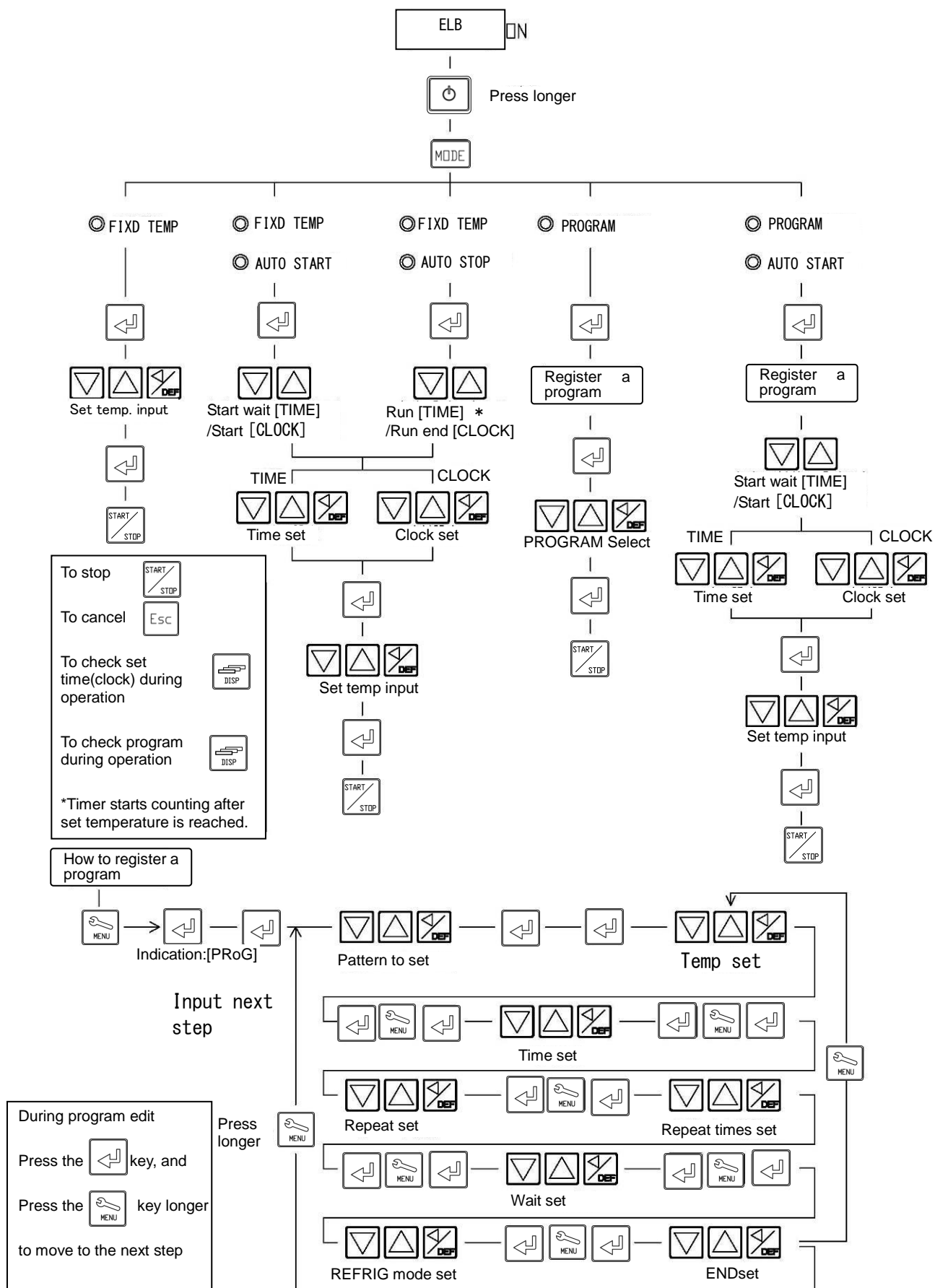

4. Operating procedures

Fixed temperature operation

The mode operates the unit continuously at a fixed temperature. Operation at the set temperature continues until operation is stopped.

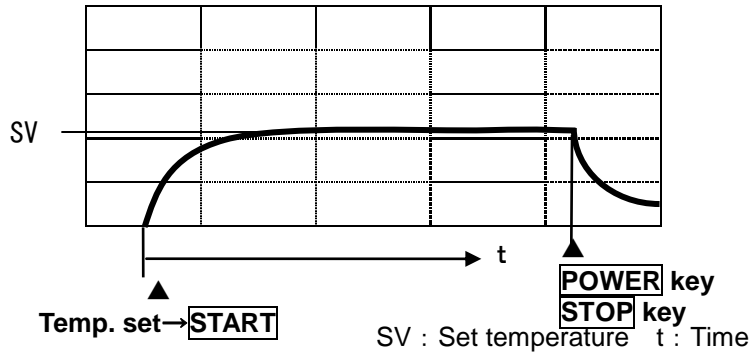

Setting fixed temperature operation

1 Turn power on

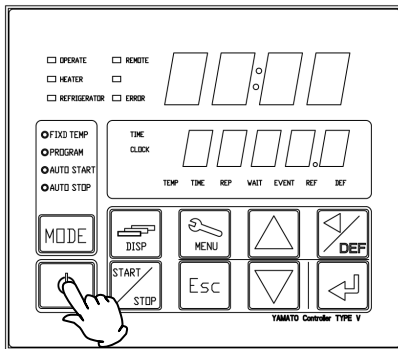

Turn the ELB at the upper right side of the unit "ON". Keeping the key pressed longer will turn power on.

Main display shows the internal temperature and the Sub display shows the set temperature.

2 Setting to the fixed temperature operation mode

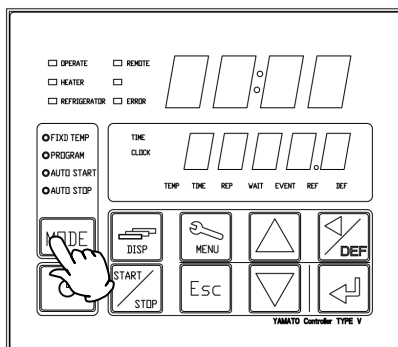

Press the key to turn the fixed temperature operation lamp on.

※When you use the unit for the first time, fixed temperature operation has been selected. Otherwise, the operation mode you selected in the last session will be selected.

3 Setting a temperature

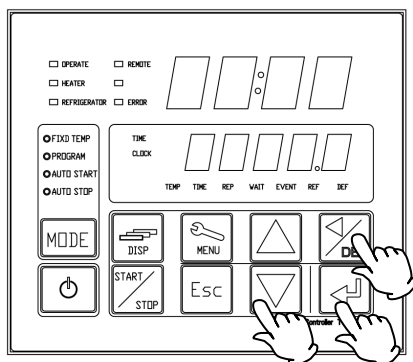

① Press the key. The numeric value to change will flash in the Sub display.

② Move the flashing indication using the key and then change the value with the keys.

Setting range : -5.0~65.0°C (available range:0~60°C)

③ When setting of the temperature has completed, decide on it with the ENTER key.

Press the key if you want to cancel during setting.

4. Operating procedures

Fixed temperature operation

4 Starting/stopping operation

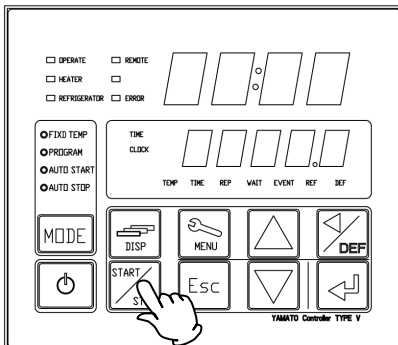

- ① You start and stop operation with the keys.

Caution

You cannot resume operation of the refrigerator for three minutes from immediately after operation stopped. In this case, the refrigerator enters the standby mode, "REFRIGERATOR lamp" flashes and operation automatically resumes after three minutes.

5 To stop operation with the timer during fixed temperature operation (Quick auto stop function)

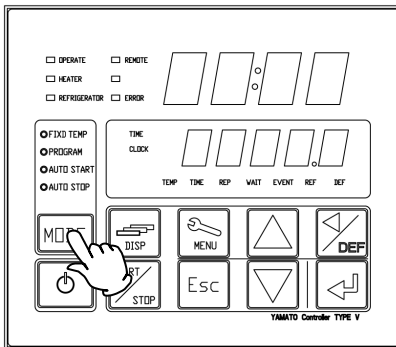

Quick auto stop function is supplied in case you want to automatically stop fixed temperature operation.

- ① Press the key during fixed temperature operation.
- ② Sub display shows QStoP and the [TIME] lamp comes on.
- ③ Select the method to stop from TIME/CLOCK with the and then press the key.
- ④ Set time (setting range: 0~99hr : 59min) or clock (24-hour format) in the Main display and then press the key.
- ⑤ When the set time of TIME/CLOCK comes, the Sub display shows End and operation stops.
- ⑥ Eliminate the End indication with the key.

Example 1 Stop time setting

Operation will stop automatically 2hr 30 min after the set temperature is attained.

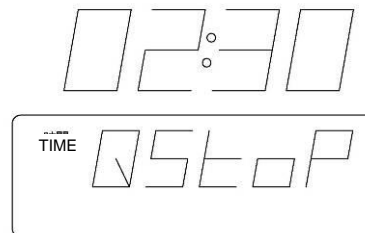

Example 2 Stop setting on the clock

Operation will stop automatically at 3:00 p.m.

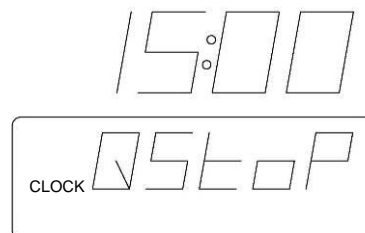

※ You can check the set TIME/CLOCK information using the key during operation.

4. Operating procedures

Auto stop operation

You can stop operation automatically with the timer in this operation mode. (When run time is set.)

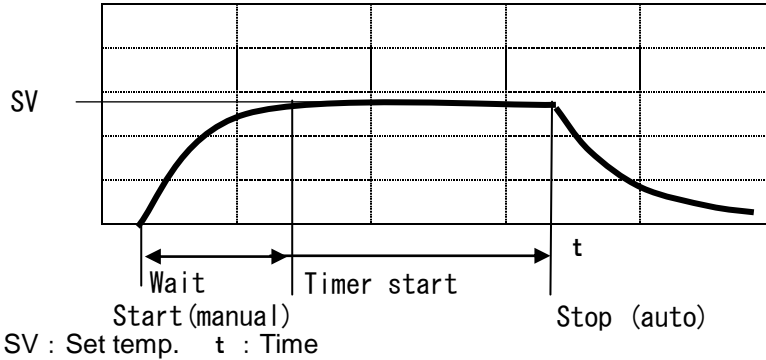

Setting the auto stop operation

1 Turning power on

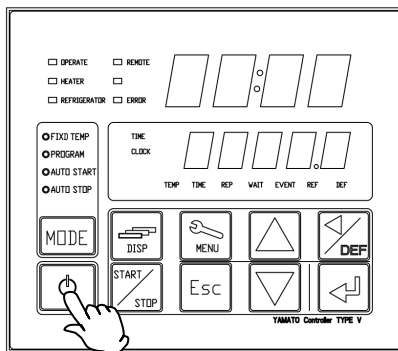

Turn the ELB at the upper right side of the main unit "ON". Keeping the key pressed longer will turn power on.

Main display shows the internal temperature and the Sub display shows the set temperature.

2 Setting to the auto stop mode

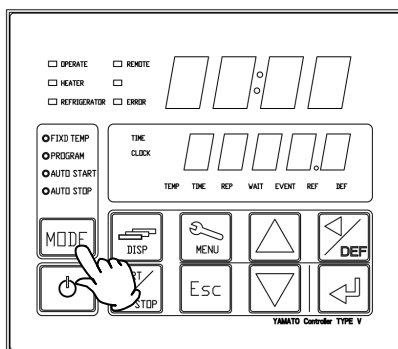

Press the key to turn the lamp for fixed temperature operation/auto stop on.

※When you use the unit for the first time, fixed temperature operation has been selected. Otherwise, the operation mode you selected in the last session will be selected.

3 Setting temperature and run time/operation stop time

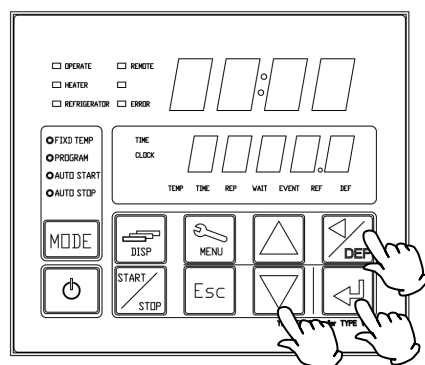

- ① Press the key, select the method to stop from TIME/CLOCK with the keys and then press the key.
- ② Set time (setting range: 0~99hr : 59min) or clock (24-hour format) in the Main display and then press the key.
- ③ Set the temperature in the Sub display and then press the key.

4. Operating procedures

Auto stop operation

Example 1 Run time setting

Operation will stop automatically 2hr 30 min after the temperature of 20°C(set temperature) is attained.

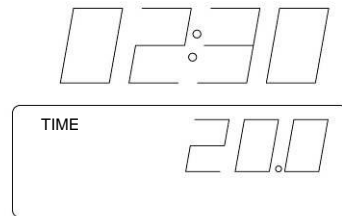

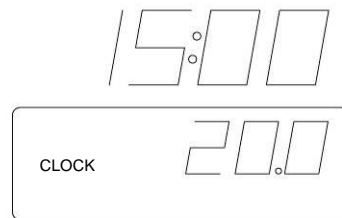

Example 2 Stop time setting

Operation is made at the set temperature of 20°C and automatically stops at 3:00 p.m.

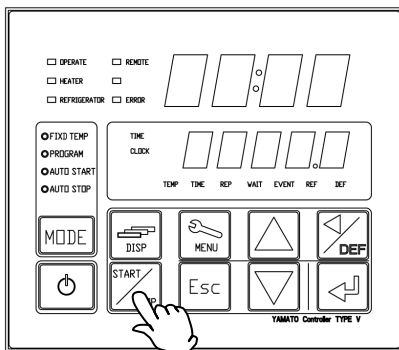

4 Starting/stopping operation



- ① Use  to start operation.
- ② When the set time of TIME/CLOCK comes, the Sub display shows END and operation stops.

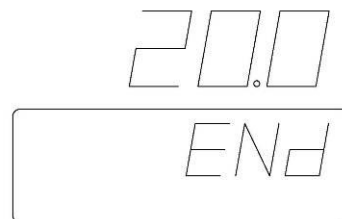

- ③ Eliminate the End indication with the  key.

※ You can check the set TIME/CLOCK information using the  key during operation.

4. Operating procedures

Auto start operation

You can start operation automatically with the timer in this operation mode. Note that operation will not stop automatically and you need to stop operation manually.

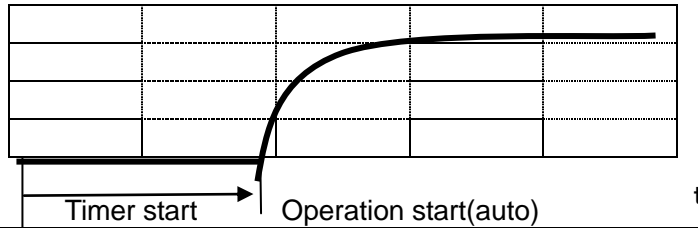

Setting the auto start operation

1 Turning power on

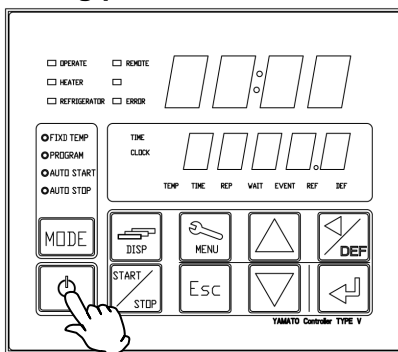

Turn the ELB at the upper right side of the unit "ON". Keeping the key pressed longer will turn power on. Main display shows the internal temperature and the Sub display shows the set temperature.

2 Setting to the auto start mode

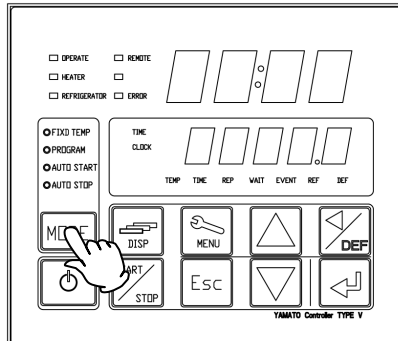

Press the key to turn the lamp for fixed temperature operation/auto stop on.

※ When you use the unit for the first time, fixed temperature operation has been selected. Otherwise, the operation mode you selected in the last session will be selected.

3 Setting the temperature & operation wait time/operation start time

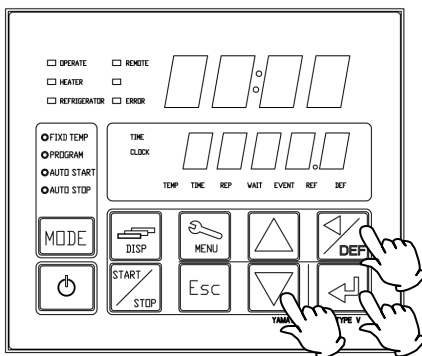

- ① Press the key, select the method to stop from TIME/CLOCK with the ▲▼ keys and then press the key.
- ② Set time(setting range:0 ~ 99hr:59min) or clock (24-hour format) in the Main display and then press the key.
- ③ Set temperature in Sub display and then press the key.

4. Operating procedures

Auto start operation

Example 1 Start time setting

Press the **START** key and operation will start at set temperature of 20°C after 2hr 30min.

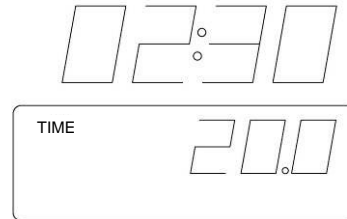

Example 2 Start setting on the clock

Press the **START** key and operation will start at set temperature of 20°C at 3:00p.m.

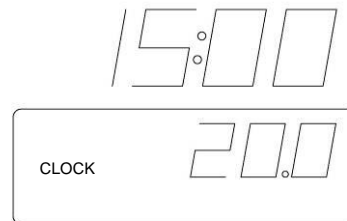

4 Starting/stopping operation

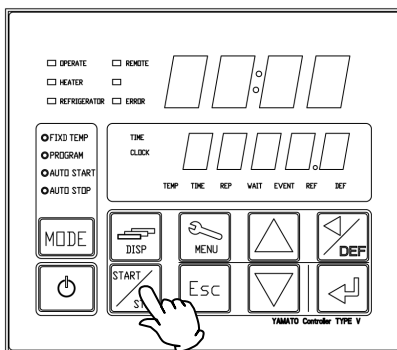

- ④ Use **START/STOP** to enter the operation start wait status.
- ⑤ The lamp flashes during operation and the set time or clock time is displayed on the Sub display.

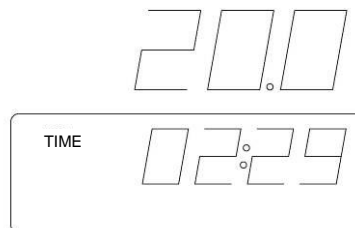

※Main display shows the internal temperature and the Sub display shows the set TIME/CLOCK. When TIME is selected, counting down of the set time will start.

- ⑥ To stop operation, use the **START/STOP** key to manually stop it.

※ You can check the set temperature with the **DISP** key during operation.

Caution

You cannot resume operation of the refrigerator for three minutes immediately after its operation stopped. In this case, it enters the standby mode and the "REFRIGERATOR" lamp flashes.

4. Operating procedures

Program operation

Operation is performed as programmed in this mode as shown in the diagram below.

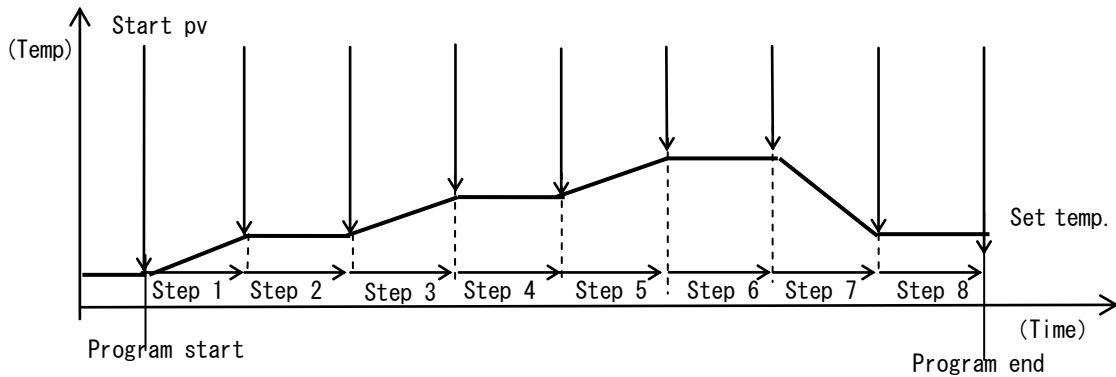

Setting the program operation

1 Turning power on

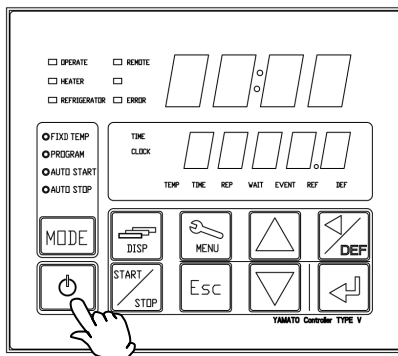

Turn the ELB at the upper right side of the unit "On". Keeping the  key pressed longer will turn power on.

Main display shows the internal temperature and the Sub display shows the set temperature.

* Register a program prior to starting a program operation.

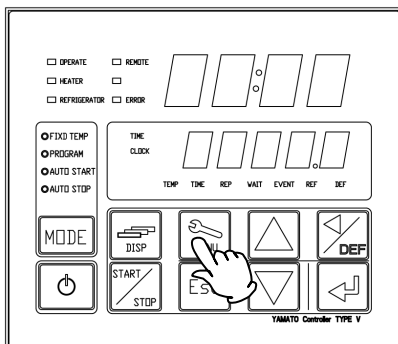

2 Registering a program



You can set up to 99 steps for a program and can save up to 99 program patterns.

(The maximum number of steps that can be saved is 99, which means you can save 10 patterns of programs when each pattern uses nine steps.)

※Note that you cannot use cross-repeating or setting of multiple destinations for return when you use the program repeat function.

Press the  key, display [PRoG] in the Sub display and then press the  key.

4. Operating procedures

Program operation

Example 1 When six steps are registered in pattern 2 and steps 3 to 6 will be repeated five times before completion. (STEP1 & 2→STEP3, 4, 5 and 6 × five time→END)

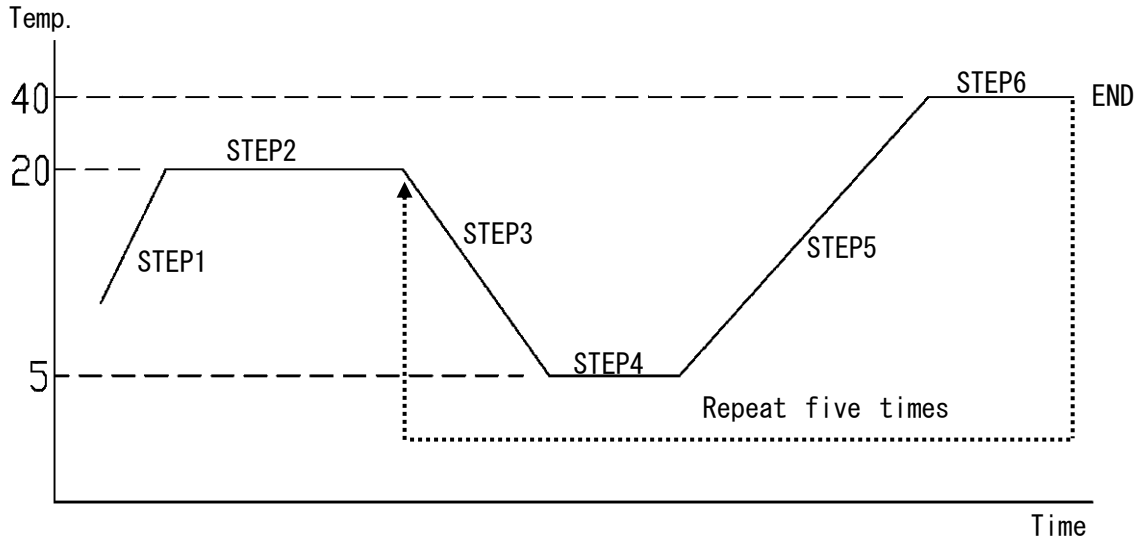









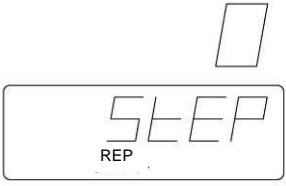

Setting conditions

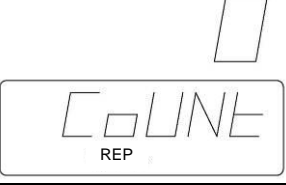
- STEP1: Setting 20°C, 0 minute, wait ON, refrigerator cnt (continuous)
- STEP2: Setting 20°C, 8 hours, wait OFF, refrigerator CYC(cycle)
- STEP3: Setting 5°C, 0 minute, wait ON, refrigerator cnt(continuous)
- STEP4: Setting 5°C, 3 hours, wait ON, refrigerator cnt(continuous)
- STEP5: Setting 40°C, two hours, wait ON, refrigerator non
- STEP6: Setting 40°C, one hour, repeat three times, repeat five times, wait ON, refrigerator non, end ON

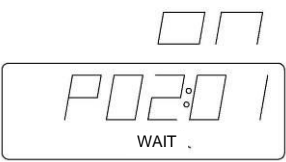
NO	Display	Operating procedures
1-1	Ordinary indication	
1-2		
Step1 1-3		Input of pattern 02, step 01 → → → → →
1-4		Input of 20°C → → → → →
1-5		Input of 00 hr 00min → → → → → →

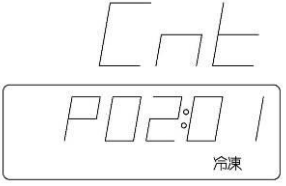
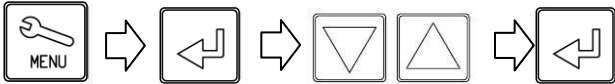
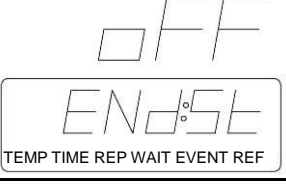
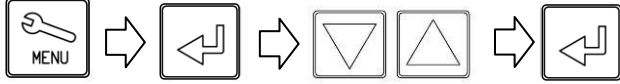
4. Operating procedures

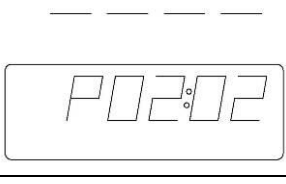
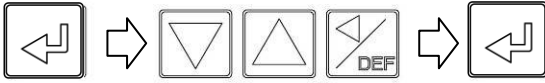
How to input a program

1-6		Input of repeat 0 (no repetition) 
1-7		Input of repeat 0 (no repetition) 
1-8		Wait function ON setting (Setting time is counted when displayed is $\pm 1^{\circ}\text{C}$ of the set temperature) 
1-9		Refrigerator mode Cnt setting 
1-10		END setting OFF (OFF for inputting the next step; on for inputting the final step) 
1-11	When setting of Step1 is completed	 Press longer
2-1		Inputting Pattern 02 and step 02 
} Step2 } Step3 } Step4 } Step5 }	<p>Input for Steps 2 to 5 according to the setting conditions as in the case of Step1.</p> <p>※ During registration of a program</p>  <p>Pressing the DISP key indicates [RESTt.P] on the Sub display and the remaining number of steps to register appears in the Main display.</p>	





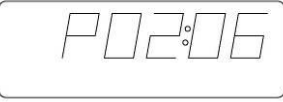
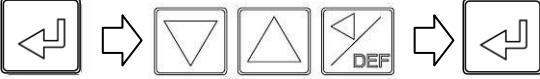
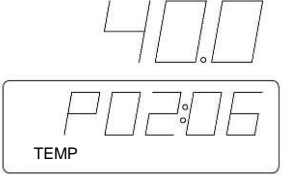
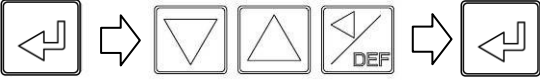
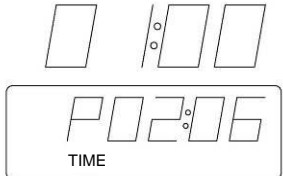
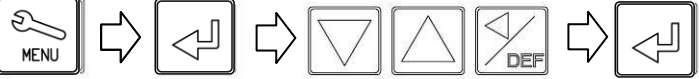
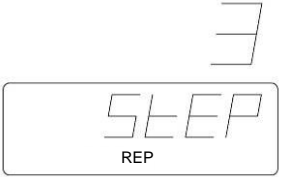
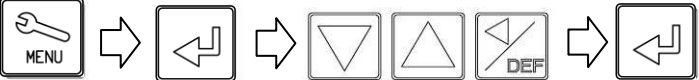
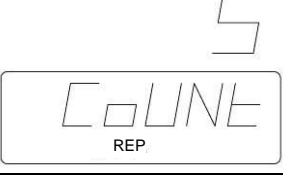
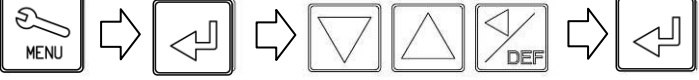
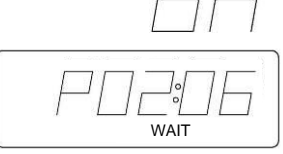
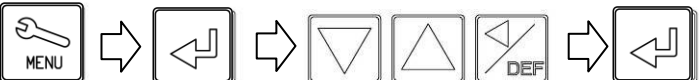
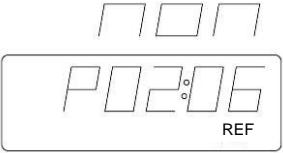
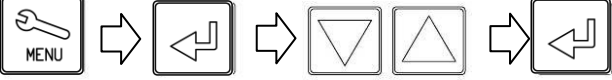
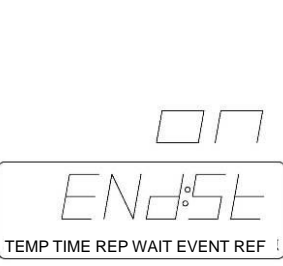
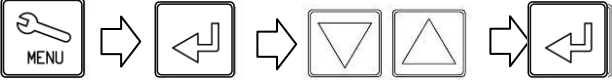





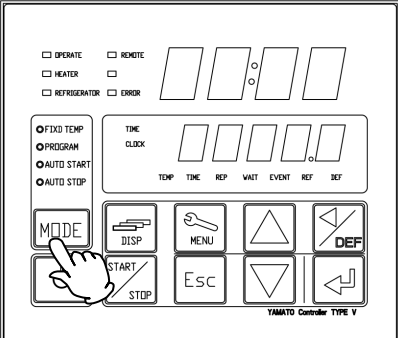
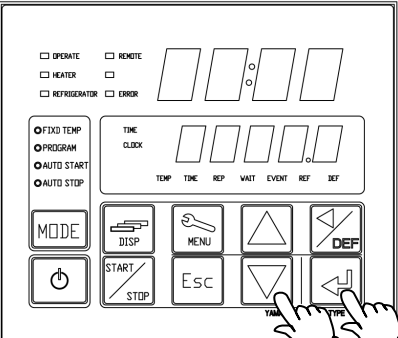

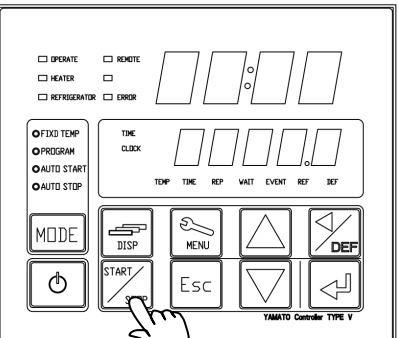

4. Operating procedures

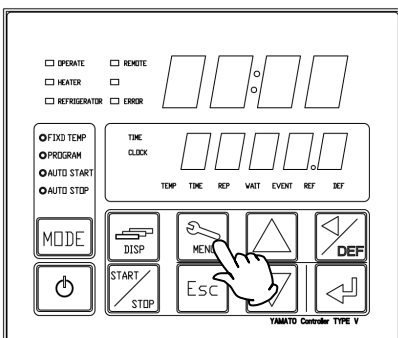
How to input a program

<p>Step6 6-1</p>		<p>Inputting pattern 02 & step 06</p> 
<p>6-2</p>		<p>Inputting 40°C</p> 
<p>6-3</p>		<p>Inputting 01hr 00min</p> 
<p>6-4</p>		<p>Inputting repeat 3 (next step returns to 3)</p> 
<p>6-5</p>		<p>Inputting the repetition times of 5(repeat five times)</p> 
<p>6-6</p>		<p>Setting wait function ON (Setting time is counted when the indicated temperature is $\pm 1^{\circ}\text{C}$ of the set temperature)</p> 
<p>6-7</p>		<p>Setting refrigerator mode non</p> 
<p>6-8</p>		<p>END setting on (oFF for inputting the next step;on for inputting the final step)</p>  <p>※You cannot switch to the program operation until you have set END.</p>

4. Operating procedures

How to input a program

<p>3</p>	<p>Selecting a program operation mode</p> 	<p>Press the MODE key to turn the lamp for the program operation on.</p> <p>※ When you use the unit for the first time, fixed temperature operation has been selected. Otherwise, the operation mode you selected in the last session will be selected.</p>
<p>4</p>	<p>Set the pattern number.</p> 	<p>Pressing the  key indicates [PGM:0X] on the Sub display. Set the number of the pattern to operate using the   keys and then decide on it with the  key.</p>
<p>5</p>	<p>Starting a program operation</p> 	<p>Use the  keys to start the program operation.</p> <p>※ Note that the program operation cannot be started if you do not set End in the final step of the program. If operation will not start, check the program setting.</p>
<p>Copying/deleting a program</p>		<ul style="list-style-type: none"> • Program copy ① Use the  key to indicate [CoPY.P] in the Sub display and then press the  key. ② When the Main display shows [SrC], input the number of patterns as the copy source in the Sub display and then press the  key. ③ When the Main display shows [dESt], input the number of patterns of the copy destination and then press the  key. • Deleting a program ① Use the  key to indicate [dEL.P] in the Sub display and then press the  key. ② When the Main display shows [dEL], input the number of patterns to delete and then press the  key.

4. Operating procedures

How to input a program

When the “start temperature” and the “set temperature” are the same, the temperature will be maintained at that level until the set time has elapsed. At this time, if the indicated temperature becomes $\pm 1^\circ\text{C}$ or more to the set temperature, the mode will change to “wait” and counting of the remaining time will be aborted.

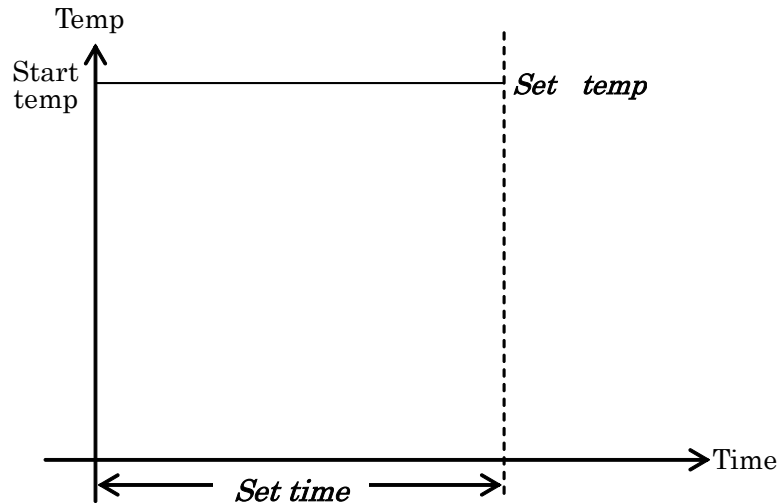

If you set “0” for the set time, the unit will operate at its full power from the “start temperature” to the “set temperature”. When you set wait ON, the “wait” status will continue until the indicated temperature come within the range of $\pm 1^\circ\text{C}$ of the set temperature.

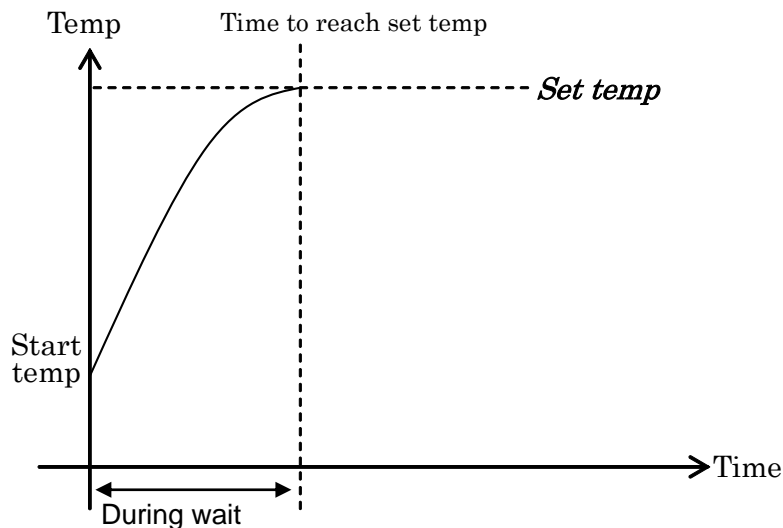

The diagram below shows the repeat concept. The first execution of the repeat intervals is not counted as repetition counts.

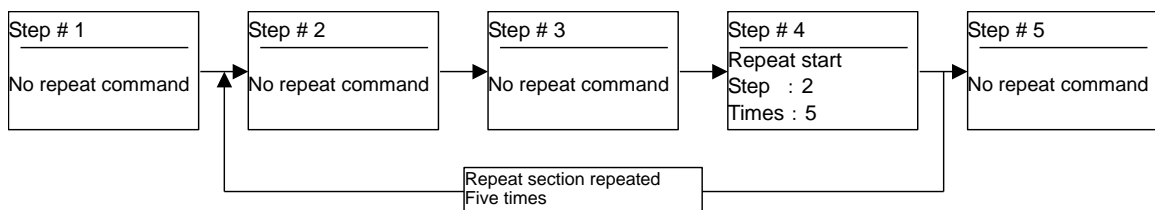

4. Operating procedures

Manual defrost

Frost may tend to form on the evaporator in the unit depending on the specific conditions during operation. Regularly check for frosting through the observation window at the back inside the unit and perform defrosting (removal of frost) if a lot of frost is found. If frequent defrosting is necessary, separately set the auto defrost function. P16 Setting auto defrost)

Note: See “P4 3.Precautions for defrosting”.

Performing manual defrost during operation

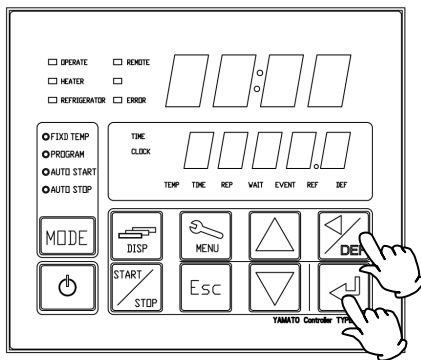

Pressing the key during operation indicates [M-dEF] in the Sub display and pressing the key starts five-minute manual defrost. During defrosting, the Sub display shows [dEF-M] and ordinary operation resumes when defrosting is completed.

* Press the key if you stop defrosting in the middle of it.

The function is enabled in the continuous and the cycle operation modes of the refrigerator.

Setting the key lock mode

1 Turning power OFF

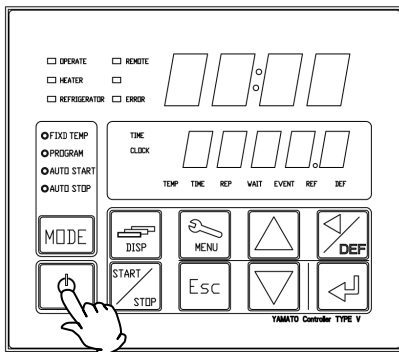

Keeping the key pressed longer will turn power OFF.

2 Entering the password

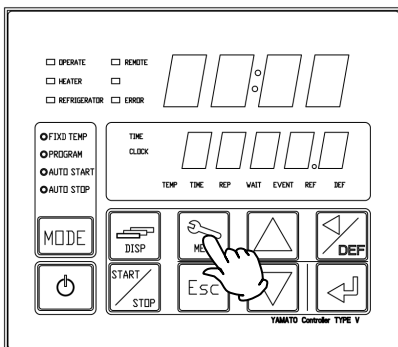

- ① If you keep the key pressed longer, the Sub display shows [UPASS] and the Main display shows a screen for entering two-digit numeric values.
- ② Use the keys to enter the password “11” and decide on it with the key.

4. Operating procedures

Setting the key lock mode

3 Setting the key lock

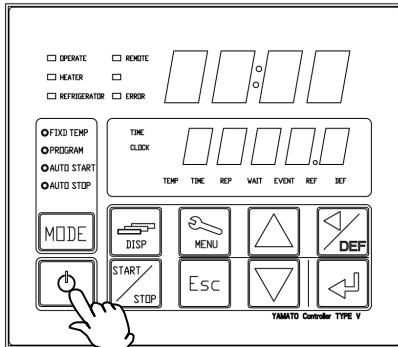

- When the Sub display shows [KLoCK], decide on it with the key.
- Use the keys to select a key lock type and decide on it with the key.
 - :Key lock function OFF (setting on shipping)
 - :Operations other than the and the START keys are disabled.
 - :Only the key is disabled.
 - :Only the key is disabled.
- Keeping the key pressed longer will return you to the ordinary screen.

Setting the recovery mode

This section describes operations after recover from a power outage

1 Turning power OFF

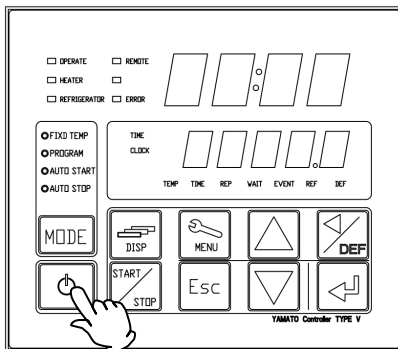

Keeping the key pressed longer will turn power OFF.

2 Entering the password

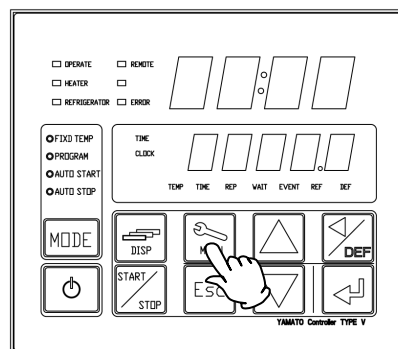

- If you keep the Key pressed longer, the Sub display shows [UPASS] and the Main display shows a screen for entering two-digit numeric values.
- Use the keys to enter the password "11" and decide on it with the key.

3 Setting recovery from a power outage

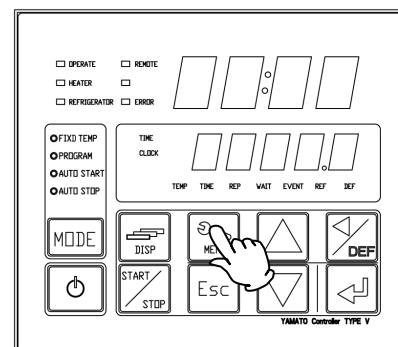

- Press the key to display [RECoV] in the Sub display and then press the key.
- Select an operation after recover and decide on it with the key.
 - Cnt : The state before power outage continues after recover from the outage.
(factory setting)
 - StoP : The unit stops after recover from power outage.
- Keeping the key pressed longer will return you to the ordinary screen.

4. Operating procedures

Setting a calibration offset

The calibration offset function offsets differences between the indicated internal temperature of the controller and measured internal temperature. This function enables parallel compensation in minus or plus direction over the whole temperature band of the unit.

Example

When the measured internal temperature is lower than the indicated one by 2°C:

You can calibrate the internal temperature against the current indication of the temperature by performing compensation by -2°C for the current indication by entering “-2” in the “Calibration offset”.

In this example, the indicated temperature of 37°C will shift to 35°C after entering offset.

※ Compensation of -2°C is applied over the whole temperature band (-5~65°C). Care must be taken for offset amount that will differ depending on the placement of specimens or the set temperature.



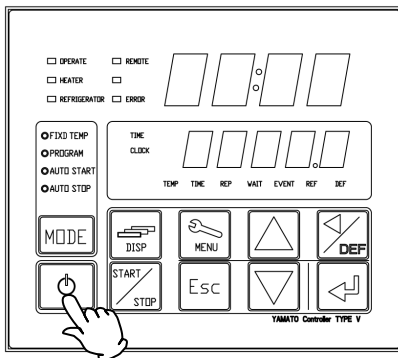

1 Turning power OFF

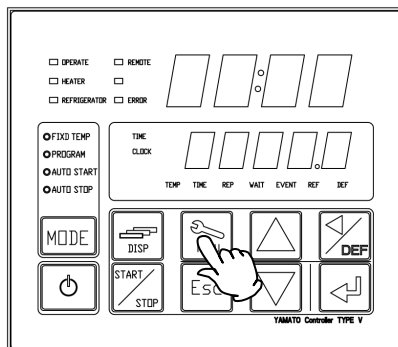

Keeping the  key pressed longer will turn power OFF.





2 Entering the password

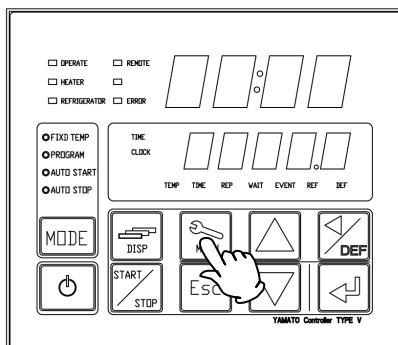

- ① If you keep the  key pressed longer, the Sub display shows [UPASS] and the Main display shows a screen for entering two-digit numeric values.
- ② Use the   keys to enter the password “11” and decide on it with the  key.

3 Setting an calibration offset



- ① Press the  key to display [CAL:oS] in the Sub display and then press the  key.
- ② Enter an offset amount using the   keys and then decide on it with the  key.

Example

Indicated temperature : 37°C, actual measured temperature : 36°C

⇒ Offset input value: -1°C

- ③ Keeping the  key pressed longer will return you to the ordinary screen.

4. Operating procedures

Backup setting

You can backup, readout and reset controller setting information.



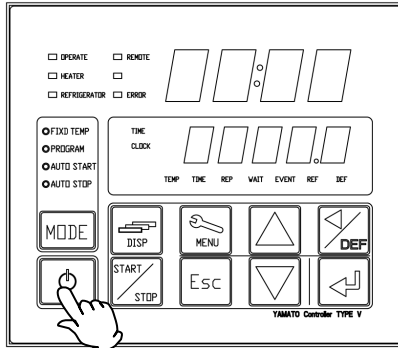

1 Turning power OFF

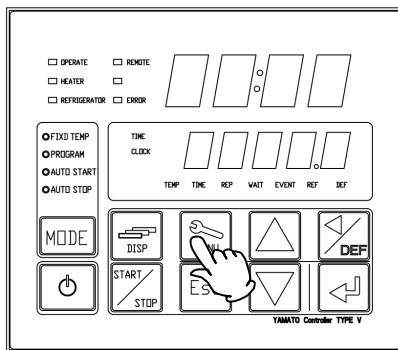

Keeping the  key pressed longer will turn power OFF.



2 Entering the password

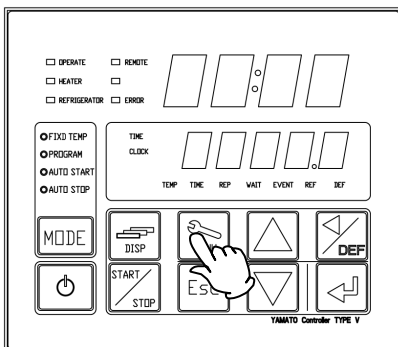

- ① If you keep the  key pressed longer, the Sub display shows [UPASS] and the Main display shows a screen for entering two-digit numeric values.
- ② Use the   keys to enter the password "11" and decide on it with the  key.

3 Performing save, readout or reset of setting information



- ① Press the  key several times until items below appear:
 - U Bks: Backup of various pieces of setting information
 - U bKR: Readout of the backup setting information
 - INI.U: Initialization of various pieces of setting information
- * Setting information includes registered programs and temperature offsets.
- ② Display the item you want and decide on it by pressing  key → [rUn] indication →  key.

44. Operating procedures

To view indications on the monitor

* "Monitor display" is a function to check power consumption or integral run time of the unit. You cannot modify the indications on the monitor.

1 Viewing the indications on the monitor

* You can check the indications on the monitor when the POWER key is on or when the unit is in operation.

Press  key longer



Power consumption kW

↓  key

Integral power consumption tot: MW

↓  key

Integral power consumption tot: kW

↓  key

CO2 discharge amount Co2 : _t

↓  key

CO2 discharge amount Co2 : KG

↓  key

Output of heater operation amount Pld : mV

↓  key

Integral live time PoW : tM

(□ × × × ×) Highest one digit only

↓  key

Integral live time PoW : tM

(× □ □ □ □) Lowest four digits only

↓  key

Integral run time RUN : tM

(□ × × × ×) Highest one digit only

↓  key

Integral run time RUN : tM

(× □ □ □ □) Lowest four digits only

↓  key

Standby screen/operation screen

Keep the  key pressed longer.

The monitor screen activates and the current power consumption will appear. Use the  key to show integral power consumption, CO2 discharge, output of PID operation amount, integral live time, and integral run time in this order. Finally, you will go out of the monitor display screen and return to the standby or operation screen.

* The current power consumption is calculated by converting instantaneous power into one-hour power. Power consumption whose integral value updated every hour is expressed as integral power consumption.

* CO2 discharge is calculated by multiplying power consumption by the conversion coefficient, which will differ depending on the local power consumption. Confirm the local conversion coefficient for CO2 discharge at the utility company before entering it.
(Initial value is the standard coefficient of TEPCO : 0.555)

* Integral **live** time shall mean accumulated time elapsed from turning the ELB ON to OFF.

Up to 65535 hours can be integrated.

Example

Highest one digit : 2

Lowest four digits : 35

⇒ Integral live time: 20035 hours

* Integral **run** time shall mean accumulated time elapsed from start to end of operation.

Up to 65535 hours can be integrated.

Example

Highest one digit : 0

Lowest four digits : 135

⇒ Integrated run time: 00135 hours

4. Operating procedures

Setting the temperature output terminal

The temperature output terminal has a function to output the temperature displayed on the controller to the recorder.

1 Turning power on

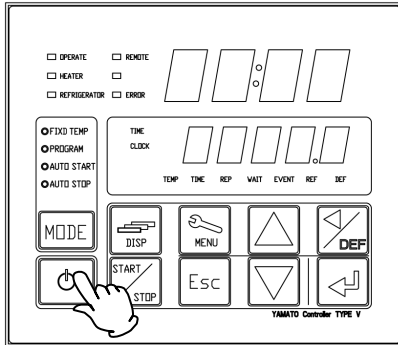

Turn the ELB at the upper right side of the unit "On". Keeping the key pressed longer will turn power ON. Main display shows the internal temperature and the Sub display shows the set temperature.

2 Setting temperature output

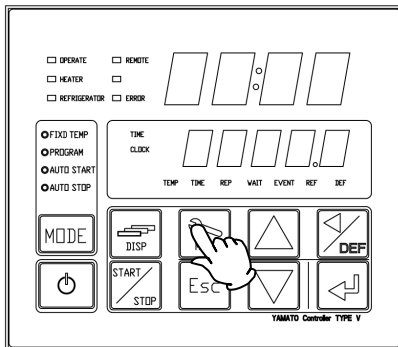

- ① Press the key to indicate Sub display [toUt] in the Sub display and decide on it with the key.
- ② Press the key to select an item to output.
 - SH* :Outputs the set temperature.
 - PH* :Outputs the indicated temperature.
 - non* :Outputs nothing.
 - rh* :Outputs heater operation amount *※
- ③ Press the key, enter the upper limit (initial value:65°C) for the output temperature and then decide on it with the key.
 - * Enter 100% for the output of heater operation amount
- ④ Press the key, enter the lower limit (initial value:-5°C) for the output temperature and then decide on it with the key.
 - * Enter 0% for the output of heater operation amount
- ⑤ Press the key to return to the initial screen.

Example Output : Current of 4~20mA will be output for temperature indication of -5~65°C when PV, 4-20.H:65 and 4-20.L:-5.

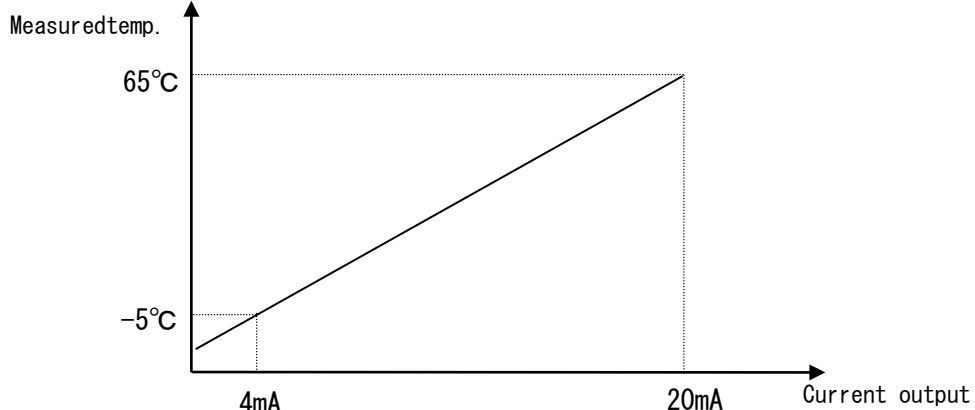

When you want to connect a terminal to the voltage input of the recorder, install a fixed resistor (shunt resistor) of 600Ω or lower.

Example When a shunt resistor of 250Ω is employed:

Indication	Output current	Voltage input to recorder
-5°C	4mA	1V
65°C	20mA	5V

4. Operating procedures

Setting external communication

External communication is a function used to remotely perform operation of the unit and monitor it by connecting to a PC.

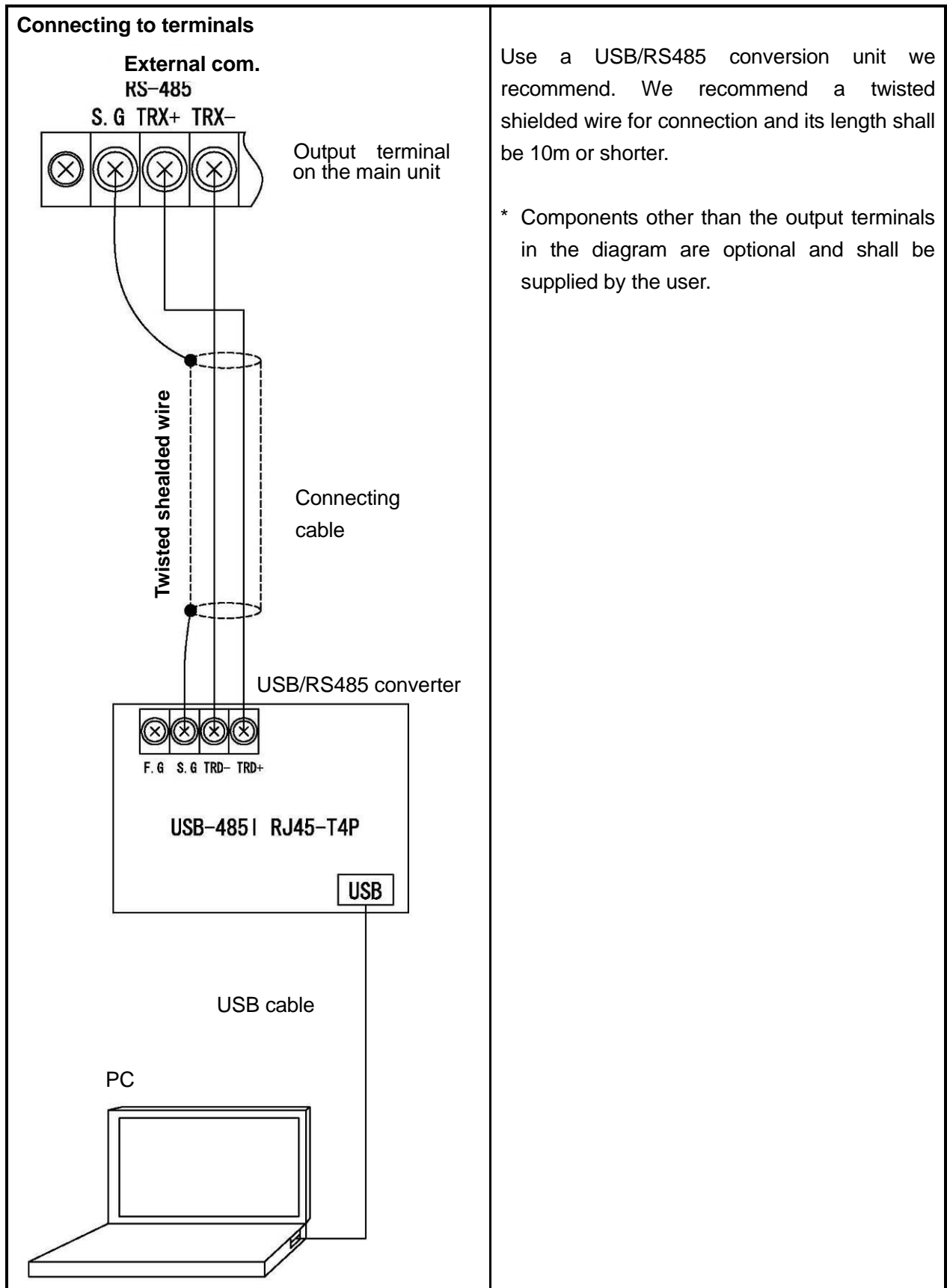

4. Operating procedures

Setting external communication

1. Settings Relating to Communication

1.1 Communication Settings

Before starting communication with the V controller (hereinafter called the "unit"), set communication parameters on the personal computer.

	Item	Communication setting
1	Communication protocol	MODBUS- <u>ASCII</u> /RTU
2	Data length	<u>7</u> /8bit
3	Parity	Non/odd/ <u>evn</u>
4	Stop bit length	<u>1</u> /2bit
5	Baud rate	<u>9600</u> /19200/38400bps
6	Response delay time	<u>0</u> 、10、20~250msec
7	Communication address	<u>1</u> ~99

Note: The values in the shaded areas () are the initial settings.

1.2 Communication Connections

- Personal computer
 - Use serial communication port (USB 1 port).
- RS232C/RS485 converter
 - For the converter, System Sacom's USB-RS485I RJ45-T4P is recommended.
 - Our optional accessory "external communication adaptor (USB-RS485)" permits the connections described in Note 1) below (except the personal computer).
- Communication cable for connection

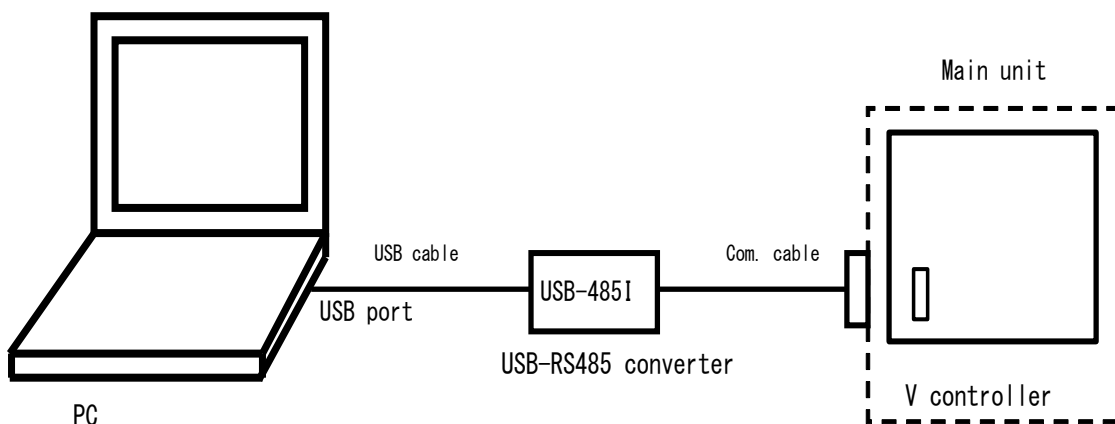

Notes: The configuration of the "External communication adaptor (USB-RS485)" included as optional part is as follows:

- ① USB cable : PC side USB connector A, USB-RS485 side USB connector B, cable length of 1.8m
- ② Com. cable : UL2464TASB 2-core AWG20 cable (3m) on the terminal bed of the USB-RS485 side, with a Y terminal on the unit
- ③ USB-RS485 conversion unit : USB-485I RJ45-T4P by System Sacom

4. Operating procedures

Setting external communication

2.Data transmission system

- Com system : Half-duplex asynchronous system (Boring selecting system)
- Com. distance : Max. 500m (depending on influences from the environment)
- Connection method : Multidrop system (Max 1 :31 stations)
- Start bit : 1 bit
- Transmission code : ASCII (ASCII mode)
Binary (RTU mode)
- Error check : LRC (ASCII mode)
CRC-16 (RTU mode)

3.Frame configuration

The RTU mode consists of a message portion only.

The ASCII mode consists of a starting character “ : (colon, 3AH)”, a message and a terminating character “CR (carriage return, ODH) + LF(line feed), OAH”.

RTU mode :

Message

ASCII mode :

:	Message	CR	LF
---	---------	----	----

4.Message configuration

The configuration of an MODBUS message is as follows for both RTU & ASCII modes:

Slave address
Function code
Data
Error check

4. Operating procedures

Setting external communication

4.1 Slave address

Slave address shall be set in the range from one to 99 beforehand. The master generally performs transmission with one slave. All of connected devices will receive messages from the master alike but the slaves that reply to those messages are limited to those slaves that have the same address as the slave address in the command message.

4.2 Function code

Function code is a function code to be executed by slaves and data pieces are roughly classified into the following groups.

Analogue settings : Various pieces of setting information. The values shall be within the 16-bit range.

-32768 to 32767

Analogue input data : Measured data, status and other data. The values shall be within the 16-bit range.

Code	Function	Unit	Functions unique to MODBUS (for reference)
03	Readout of analogue settings	16 bit	Readout of contents in the holding register
04	Readout of analogue input data	16 bit	Readout of contents in the input register
06	Write of analogue settings	16 bit	Write in the single holding register

4.3 Data part

Data configuration differs depending on function codes.

Data requested by the master consists of the number of codes and number of data pieces to be read or written.

Replies from a slave consist of data to the request.

All basic MODBUS data consists of 16-bit integers and whether they have a sign or not depends on specific data. Thus, values are expressed by allocating the decimal point to a different address to make them integers or by fixing the decimal point and normalizing the values with the upper and lower limits of the scale.

4.4 Reference

Data has a number "Reference #" allocated and which number is necessary for reading out and writing of that data.

The numbers are classified depending on their types into: "analogue input data" and "analogue settings".

Data type	Reference #	Relative numbers
Analogue input data	30001 ~ 40000	Reference # - 30001
Analogue settings	40001 ~ 50000	Reference # - 40001

4.5 Error check

Error check system for transmission frames differs depending on the specific mode.

RTU : CRC-16

ASCII : LRC

4. Operating procedures

Setting external communication

4.5.1 Calculation of CRC-16

In the CRC system, information to send is divided with a generating polynomial and suffixing the generated remainder to the information.

The generating polynomial is as follows:

$$1 + X^2 + X^{15} + X^{16}$$

The following calculation procedures are applied to from the Slave address to the end of data.

1. Initialization of CRC—16 data (defined as X)(=FFFFH)
2. Exclusive or (EX-OR) of data 1 and X→X
3. Shift X to the right by one bit→X
4. When a carry has occurred, calculate EX-OR with A001H. If not, go to 5.→X
5. Repeat steps 3 and 4 until shifts occur eight times.
6. EX-OR of the next data and X→X
7. Same as steps 3 to 5.
8. Repeat these steps up to the last data.
9. Create messages for the calculated 16-bit data (X) from the lowest data first.

Example: When data is [02H] and [07H], CRC—16 will be 1241H and thus the resulting error check data will be [41H] and [12H].

4.5.2 Calculation of LRC

The following calculation procedures are applied to from the Slave address to the end of data.

1. Create a message in the RTU mode.
2. Add up from the beginning of the data (Slave address) to the end.→X
3. Complement X (bit reversed)→X
4. Add 1. (X=X + 1)
5. Suffix X to the end of the message as LRC.
6. Convert the whole data into ASCII characters.

Example: When data is [02H] and [07H], LRC will be [F7H] and thus a binary message will be [02H] [07H] [F7H]; an ASCII message will be [30H] [32H] [30H] [37H] [46H] [37H].

4. Operating procedures

Setting external communication

4.6 Details of function codes

Replies by each of function codes are shown below.

4.6.1 Readout of analogue settings

[Function code : 03 (03H)]

Readout will be made for "Analogue settings (2 byte : 16 bit) data" whose numbers are continuous for the specified number of values starting with the specified number. Data is divided into high 8 bits and low 8 bits, which then will be arranged in the order of their numbers to form data for the reply message.

Example: Readout of fixed temperature operation SV temperature setting, fixed value auto start SV temperature setting, fixed value auto start time/clock time select setting of slave 1.

(Readout of three analogue settings of slave 1 from reference #40001 to 40003)

Reference # (relative numbers)	40001 (0000H)	40002 (0001H)	40003 (0002H)
Data	650 (028AH)	-50 (FFCEH)	0 (0000H)

〈RTU mode〉

Master→device

Slave address	01H
Function code	03H
Starting number(H)	00H
Starting number (L)	00H
Quantity (H)	00H
Quantity (L)	03H
CRC (L)	05H
CRC(H)	CBH

Device→master (normal)

Slave address	01H
Function code	03H
Number of data pieces	06H
Fixed valueSV (H)	02H
Fixed valueSV (L)	8AH
Fixed value AT STA SV (H)	FFH
Fixed value AT STA SV (L)	CEH
Fixed value timeselect (H)	00H
Fixed value timeselect (L)	00H
CRC (L)	E8H
CRC (H)	A3H

〈Error check in the ASCII mode〉

LRC	F9H	LRC	9DH
-----	-----	-----	-----

Note: Starting number (relative number) is "Reference #—40001".

Note: The number of data pieces is the number of bytes of the data.

(This is different from the requested number. In the example, the requested number is three while the number of pieces of the data is six.)

4. Operating procedures

Setting external communication

4.6.2 Readout of analogue input data

[Function code : 04 (04H)]

Readout will be made for "Analogue input (2 byte : 16 bit) data" whose numbers are continuous for the specified number of values starting with the specified number. Data is divided into high 8 bits and low 8 bits, which then will be arranged in the order of their numbers to form data for the reply message. The example of reply is the same as the "Function code03". But the starting number (relative number) is "Reference #—30001".

4.6.3 Write of analogue settings

[Function code : 06 (06H)]

The analogue setting with the specified number is made to the specified value.

Example: Setting the fixed temperature operation SV temperature of slave 1 to100.

〈RTU mode〉

Master→device

Slave address	01H
Function code	06H
Setting # (H)	00H
Setting # (L)	00H
Setting data (H)	00H
Setting data (L)	64H
CRC(L)	88H
CRC(H)	21H

Device→master (normal)

Slave address	01H
Function code	06H
Setting #(H)	00H
Setting #(L)	00H
Setting data (H)	00H
Setting data (L)	64H
CRC (L)	88H
CRC (H)	21H

〈Error check in the ASCII mode〉

LRC	95H
-----	-----

LRC	95H
-----	-----

Note: Setting number (relative number) is "Reference #—40001".

Note: Normal reply is the same as for the command message.

4. Operating procedures

Setting external communication

4.7 Process of an abnormality

When no reply will be returned

No reply will be returned ignoring the message in the following cases:

- ① An transmission error (overrun, framing, parity, CRC or LRC) is found in the message.
- ② The slave address in the message is different from my address.
- ③ Data interval of the message is long.

When RTU is less than 9600bps : 20msec or higher

9600bps or more : 5msec or higher

ASCII···1 second or more

- ④ When transmission parameters do not match.
- ⑤ The size of the received message exceeds the acceptable number of bytes.

Replying an error message

When any of the troubles below is detected even though the message from the master does not contain any errors, a code that describes that error will be returned as an “error message”.

The error message format is as follows:

Slave address
Function code+80H
Error code
CRC(L)
CRC(H)

Function code	Function code +80H
03	83H
04	84H
06	86H

4. Operating procedures

Setting external communication

4.8 Communication error codes

Communication error codes are as follows.

Error code	Description
01H	Function code error When a function code other than those defined is received.
02H	Relative number (Reference #) error When the starting or setting number received is the one not defined.
03H	Incorrect number of data pieces <ul style="list-style-type: none">▪ When the number of pieces exceeds the specified number for data to be transmitted to the received message.▪ When the requested number is 0(zero).▪ When the number of pieces of received data does not match with the actual number of data pieces.
11H	Outside the setting range When a value set is outside the setting range defined in the reference table.
12H	This code is not available for setting.

4. Operating procedures

Setting external communication

4.9 List of references

Reference #	FNC code	R/W	Data name	Setting range (in the communication mode)	Initial value	Remarks
40001	03 06	R W	Fixed temperature operation SV temp. setting	SLL~SLH	0.0°C	PV decimal point *Offset to SLL~SLH.
40002	03 06	R W	Fixed value auto start SV temp. setting	SLL~SLH	0.0°C	PV decimal point *Offset to SLL~SLH.
40003	03 06	R W	Fixed value auto start time/clock select setting	TIME/CLOCK (0/1)	Hour	
40004	03 06	R W	Fixed value auto start time setting(H)	00~99 (0~99)	00	H : Hour
40005	03 06	R W	Fixed value auto start time setting(L)	00~59 (0~59)	00	L : Minute
40006	03 06	R W	Fixed value auto start time setting(H)	00~23 (0~23)	00	H : Hour
40007	03 06	R W	Fixed value auto start clock setting(L)	00~59 (0~59)	00	L : Minute
40008	03 06	R W	Fixed value auto stop SV temp. setting	SLL~SLH	0.0°C	PV decimal point *Offset to SLL~SLH.
40009	03 06	R W	Fixed value auto stop Time/clock select setting	TIME/CLOCK (0/1)	Hour	
40010	03 06	R W	Fixed value auto stop time setting(H)	00~99 (0~99)	00	H : Hour
40011	03 06	R W	Fixed value auto stop time setting (L)	00~59 (0~59)	00	L : Min
40012	03 06	R W	Fixed value auto stop clock setting(H)	00~23 (0~23)	00	H : Hour
40013	03 06	R W	Fixed value auto stop clock setting(L)	00~59 (0~59)	00	L : Min
40014	03 06	R W	Fixed temperature operation quick auto stop time/clock select setting	TIME/CLOCK (0/1)	Time	
40015	03 06	R W	Fixed temperature operation quick auto stop time setting(H)	00~99 (0~99)	00	H : Hour

4. Operating procedures

Setting external communication

Reference #	FNC code	R/W	Data name	Setting range (in the communication mode)	Initial value	Remarks
40016	03 06	R W	Fixed temp. operation quick auto stop time setting(L)	00~59 (0~59)	00	L : Minute
40017	03 06	R W	Fixed temp. operation quick auto stop clock setting(H)	00~23 (0~23)	00	H : Hour
40018	03 06	R W	Fixed temp. operation quick auto stop clock setting(L)	00~59 (0~59)	00	L : Minute
40019	03 06	R W	Program run pattern # setting	0~99 (0~99)	0	*Cannot be set during program run.
40020	03 06	R W	Program run auto start pattern # setting	0~99 (0~99)	0	*Cannot be set during program auto start.
40021	03 06	R W	Program run auto start time/clock select setting	TIME/CLOCK (0/1)	Time	
40022	03 06	R W	Program run auto start time setting(H)	00~99 (0~99)	00	H : Hour
40023	03 06	R W	Program run auto start time setting(L)	00~59 (0~59)	00	L : Minute
40024	03 06	R W	Program run auto start clock setting(H)	00~23 (0~23)	00	H : Hour
40025	03 06	R W	Program run auto start clock setting(L)	00~59 (0~59)	00	L : Minute

4. Operating procedures

Setting external communication

Reference #	FNC code	R/W	Data name	Setting range (in the communication mode)	Initial value	Remarks
40027	03	R	Integral power consumption monitor KW/h	0~999KW/h (0~999)	0 KW/h	
40028	03	R	Integral power consumption monitor MW/h	0~999MW/h (0~999)	0 MW/h	
40029	03	R	Integral CO2 consumption monitor Kg	0~999Kg (0~999)	0 Kg	
40030	03	R	Integral CO2 consumption monitor t	0~999t (0~999)	0 t	
40031	03	R	Operation amount MV monitor	0.0~100.0% (0~1000)	0.0%	
40032	03	R	Integral time monitor Integral live time	max : 65535h (0~65535)	0h	
40033	03	R	Integral time monitor Integral run time	max : 65535h (0~65535)	0h	
40034	03	R	Present power consumption display	0.0~999.9KW/h (0~9999)	0 KW/h	

4. Operating procedures

Setting external communication

Reference #	FNC code	R/W	Data name	Setting range (in the communication mode)	Initial value	Remarks
41001	03 06	R W	Key lock setting	OFF/MLOC/FLOC/ ON (0/1/2/3)	OFF	
41002	03 06	R W	Buzzer sound setting	ON/CLK(click OFF)/OFF (0/1/2)	ON	
41003	03 06	R W	Calendar setting Year	2010~2099 (10~99)	2010	
41004	03 06	R W	Calendar setting Month	1~12(month) (1~12)	1 month	
41005	03 06	R W	Calendar setting Day	1~31(day) (1~31)	1 day	
41006	03 06	R W	Calendar setting Hour	0~23 hour (0~23)	0 hour	
41007	03 06	R W	Calendar setting Minute	0~59 分 (0~59)	0 minute	* Second is fixed at 0(zero).
41008	03 06	R W	Refrigerator control function select	NON/2P/CYC/CNT (0/1/2/3)	2P	*Setting differs depending on the mode.
41009	03 06	R W	Refrigerator cycle run ON time setting	0~120min (0~120)	30 min	*Setting differs on the mode.
41010	03 06	R W	Refrigerator cycle run OFF time setting	0~120min (0~120)	10 min	Reboot protection time \leq OFF time *Setting differs depending on the mode.
41011	03 06	R W	Defrost operation mode setting	NON(N/A)/CLK (clock time) /TIME(time) (0/1/2)	NON	Auto setting *Setting differs depending on the mode.
41012	03 06	R W	Defrost operation start time setting(H)	00~23 (0~23)	00	H : Hour *Setting differs on the mode.
41013	03 06	R W	Defrost operation start time setting(L)	00~59 (0~59)	00	L : Minute *Setting differs depending on the mode.

4. Operating procedures

Setting external communication

Reference #	FNC code	R/W	Data name	Setting range (in the communication mode)	Initial value	Remarks
41014	03 06	R W	Defrost operation interval setting	1~96h (1~96)	24 h	Auto operation only. *Setting differs depending on the mode.
41015	03 06	R W	Defrost operation time setting	0~59min (0~59)	5 min	Common for auto and manual *Setting differs depending on the mode.
41043	03 06	R W	CO2 discharge conversion coefficient	0.001~9.999 (1~9999)	0.555	
41045	03 06	R W	Calibration offset	-CAL.L~CAL.L	0.0	*Offset to -CAL.L ~ CAL.L.
42012	03 06	R W	Compensation for power outage setting	CNT/STP (0/1)	CNT	

44. Operating procedures

Setting external communication

Reference #	FNC code	R/W	Data name	Setting range (in the communication mode)
30101	04	R	Measured temp. monitor (PV)	PT1 : -110°C~110°C +over range : 32767 -over range : -32768 PV decimal point
30102	04	R	PV decimal point position setting	DP.0/DP.1(0/1)
30103	04	R	Target temperature during run(SV)	SV during RUN(Target SV during program run) -1999~9999°C 0°C during READY PV decimal point
30104	04	R	Execution temp. during run(SV)	Execution SV during program run -1999~9999°C 0°C during READY PV decimal point
30105	04	R	Operation amount monitor (MV)	-10.0~110.0%
30107	04	R	RUN/READY status monitor	<p>【High byte】</p> <p>0:fixed temperature operation 1:Fixed value auto start 2:Fixed value auto stop 3:Program run 4:Program auto start</p> <p>【Low byte】</p> <p>0=READY(standby) 1=RUN(during operation) 2=END(end)</p>

4. Operating procedures

Setting external communication

Reference #	FNC code	R/W	Data name	Setting range (in the communication mode)																
30108	04	R	Error status monitor	BIT0=Temperature sensor error BIT1=Triac short circuit BIT2=Heater disconnection BIT3=Fan error BIT4= BIT5=Standalone overheat preventive device error BIT6= BIT7=Melting of main relay contact BIT8=Refrigerator error BIT9=RAM error BIT10=EEPROM error BIT11= BIT12= BIT13=Inverter error BIT14=High voltage error BIT15= Low <table border="1" style="margin-left: auto; margin-right: auto;"> <tr> <td>7</td><td>6</td><td>5</td><td>4</td><td>3</td><td>2</td><td>1</td><td>0</td> </tr> </table> High <table border="1" style="margin-left: auto; margin-right: auto;"> <tr> <td>15</td><td>14</td><td>13</td><td>12</td><td>11</td><td>10</td><td>9</td><td>8</td> </tr> </table> 0=No error 1=Error found	7	6	5	4	3	2	1	0	15	14	13	12	11	10	9	8
7	6	5	4	3	2	1	0													
15	14	13	12	11	10	9	8													
30109	04	R	Warning status monitor	BIT0= BIT1= BIT2=Software overheat error <table border="1" style="margin-left: auto; margin-right: auto;"> <tr> <td>7</td><td>6</td><td>5</td><td>4</td><td>3</td><td>2</td><td>1</td><td>0</td> </tr> </table> 0=Warning OFF 1=Warning ON	7	6	5	4	3	2	1	0								
7	6	5	4	3	2	1	0													
30110	04	R	No. of pattern/step being executed	【High byte】 Pattern No. 0~99(0=standby) 【Low byte】 Step No. 0~99(0=standby)																

4. Operating procedures

Setting external communication

Reference #	FNC code	R/W	Data name	Setting range (in the communication mode)
30111	04	R	Destination No. of step repetition being executed/remaining number of step repetition	【High byte】 Repetition destination No.0~99 【Low byte】 Remaining repetition number: 0~99/255(INF=255)
30112	04	R	Remaining time of fixed value auto start	【High byte】 Hour : 0~99 【Low byte】 Minute : 0~59
30113	04	R	Remaining time of fixed value auto stop	【High byte】 Hour : 0~99 【Low byte】 Minute : 0~59
30114	04	R	Remaining time of fixed value quick auto stop	【High byte】 Hour : 0~99 【Low byte】 Minute : 0~59
30115	04	R	Remaining time of program run auto start	【High byte】 Hour : 0~99 【Low byte】 Minute : 0~59
30116	04	R	Remaining time of step being executed	【High byte】 Hour : 0~99/255(INF=255) 【Low byte】 Minute : 0~59/255(INF=255)
30117	04	R	Device status monitor	bit0:Remaining time of fixed value auto start(0=count stop; 1=counting) bit1:Remaining time of fixed value auto stop(0=count stop; 1=counting) bit2:Remaining time of quick auto stop(0=count stop; 1=counting) bit3:Remaining time of program run auto start(0=count stop; 1=counting) bit4:Remaining time of program run step being executed (0=count stop; 1=counting) bit5:Remote/Local status(0=Local; 1=Remote) bit6:Defrost status(0=Defrost stop; 1=Defrosting) bit7:Program run repetition status(0=No repetition; 1=Repeating) Bit8:Quick auto stop status(0=No auto stop; 1=during auto stop) Bit9:Power key status(0=OFF; 1=ON)

44. Operating procedures

Setting external communication

Reference #	FNC code	R/W	Data name	Setting range (in the communication mode)
30131	04	R	Integral live time monitor	max : 65535h
30132	04	R	Integral run time monitor	max : 65535h
30133	04	R	Power consumption monitor (KW/h)	0~999KW/h
30134	04	R	Power consumption monitor (MW/h)	0~999MW/h
30135	04	R	CO2 consumption monitor(Kg)	0~999Kg
30136	04	R	CO2 consumption monitor(t)	0~999t
30137	04	R	Present power consumption display	0~999KW/h

4. Operating procedures

Setting external communication

Reference #	FNC code	R/W	Data name	Setting range (in the communication mode)
31001	04	R	Pattern #	1~99
31002	04	R	Step #	1~99
31003	04	R	Ending step setting	OFF/ON
31004	04	R	Step temp. setting	PV decimal point SLL~SLH
31005	04	R	Step time setting (H)	00~99/INF
31006	04	R	Step time setting(L)	00~59/INF
31007	04	R	Repeat setting (repeat destination)	0~98
31008	04	R	Repeat setting (times)	0~99/INF
31009	04	R	Wait setting	OFF/ON
31013	04	R	Refrigerator operation setting	NON/2P/CYC/CNT

* Steps 2 to 98 are omitted.

* 1 step= 15 reference unit



4. Operating procedures

Setting external communication

Reference #	FNC code	R/W	Data name	Setting range (in the communication mode)
32471	04	R	Pattern #	1~99
32472	04	R	Step #	1~99
32473	04	R	Ending step setting	OFF/ON
32474	04	R	Step temp. setting	PV decimal point SLL~SLH
32475	04	R	Step time setting(H)	00~99/INF
32476	04	R	Step time setting(L)	00~59/INF
32477	04	R	Repeat setting (destination)	0~98
32478	04	R	Repeat setting(times)	0~99/INF
32479	04	R	Wait setting	OFF/ON
32483	04	R	Refrigerator operation setting	NON/2P/CYC/CNT

About external communication



Never attempt to access any addresses not listed in the reference addresses above when you use the remote setting or operation of the unit using external communication. Otherwise, a malfunction to the product may result and the unit may become uncontrollable.

4. Operating procedures

Setting external communication

5. Wire connection

Here is an example of a multi drop wire connection.

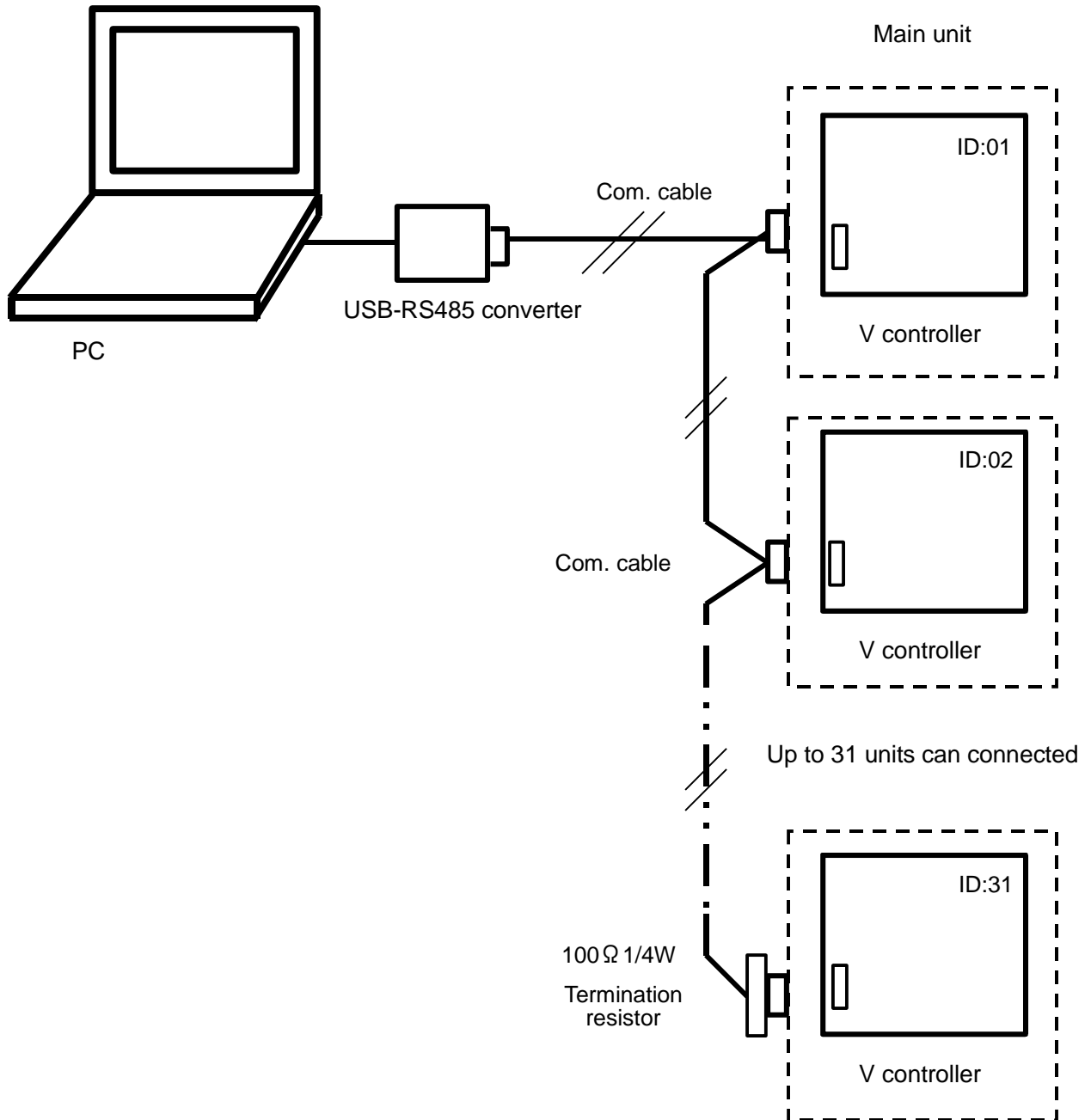

Note: Termination resistor shall be separately ordered.

If you supply a termination resistor, connect a fixed resistor rated 100 Ω 1/4W or more to the last terminal block of the cable device.

4. Operating procedures

Setting time-up output (optional)

Time-up output is a function that outputs a signal when operation is terminated (END indication).

Connecting terminals

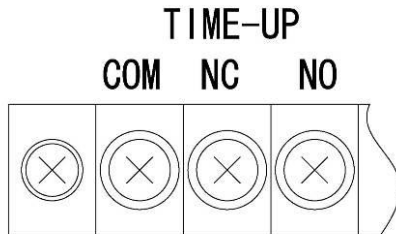

Connect the time-up output terminal at the upper right side of the unit.

COM } Connect the a contact(relay contact).
NO }

COM } Connect the b contact(relay contact).
NC }

Contact capacity: AC250V 1A(resistance load)
DC30V 1A(resistance load)

*About the time-up output timing

Sub display shows "END" at the end of program run or auto stop run. A time-up signal will be output while this "END" is displayed.

Pressing the **START/STOP** key deletes "END" indication when time-up output is cancelled as well.

Setting external alarm output (optional)

External alarm is a function that outputs a signal when an error occurs to the main unit.

Connecting terminals

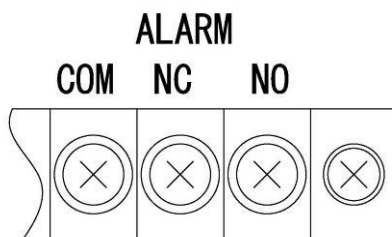

Connect to the external alarm output terminal at the upper right side of the main unit.

COM } Connect the a contact(relay contact).
NO }

COM } Connect the b contact (relay contact).
NC }

Contact capacity:AC250V 1A(resistance load)
DC30V 1A(resistance load)

* About the external alarm output

An error code will be displayed when an error occurs. An external alarm signal is output while the error code is displayed.

4. Operating procedures

About the standalone overheat preventive device

Setting a temperature on the standalone overheat preventive device

* Setting a temperature with the ▼▲ keys.

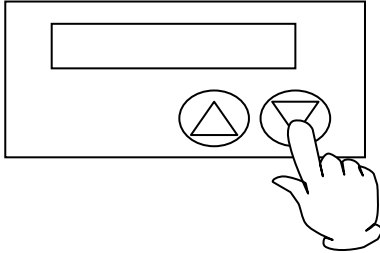

About the standalone overheat preventive device



Operation may stop when the difference between the set temperature on the standalone overheat preventive device and that on the controller, which activates the preventive device. Set the temperature for the standalone overheat preventive device to a temperature by at least 10°C higher than that of the controller. Note that the standalone overheat preventive device cannot be employed for protecting specimens. The factory setting of the temperature is 75°C. The settable range is between 0°C and 75°C.

If you want to operate the standalone overheat preventive device at a temperature you want, first operate the unit with its inside being stably kept at that temperature, slowly lower the setting on the standalone overheat preventive device and make sure that it securely operates at the desired temperature and then start operating. Wait for five seconds until the unit starts to operate before checking. When the device is activated, Er07 is indicated and operation will stop. When you have changed the set temperature on the standalone overheat preventive device, registration of the temperature takes about five seconds during which you should wait before turning its power off.

5. Handling precautions



Warning

1. About the substance which must not be used



Never use an explosive material, a flammable material, or a material that contains such materials for this unit. They may cause an explosion or a fire. (See P.70 "List of dangerous materials".)

2. Ban on use/countermeasures when an error occurs



If smoke is emerges on the unit or an odd odor is felt, immediately turn the power of the main unit off, turn the power supply off and contact your dealer, a Yamato sales office or our customer service center for inspection. Otherwise, a fire or an electrical shock may result. The user shall never attempt to repair the unit to avoid any possible dangers.



Caution

1. . Do not step on the unit.



Do not step on the unit. Otherwise, the unit may trip over or be damaged resulting a personal injury or a malfunction.

2. Do not place any objects on the unit



Do not place any objects on the unit. They may fall off and cause a personal injury. In addition, do not put paper or other easily flammable items around the unit.

3. When a thunder is heard.



When a thunder is heard, turn the power of the main unit off then turn the main power supply off immediately. Otherwise, a lightning strike may result and cause a fire.

4. Precautions about placement of specimens



Placing too much specimen may hinder proper temperature control. Do not operate the unit under overload in order to assure temperature accuracy.

5. About recovery from power outage



When power supply to the unit has recovered after having stopped operation from a power outage, the unit will operate in either of two ways below depending on the setting you have selected.

- If recovery has been set, the unit will return to the status immediately before the power outage when power supply recovers. When power outage occurs during operation, the unit will recover to the operating status and continue operation.
- If recovery has not been set, the power key of the unit will shift to OFF status when the power supply recovers. When power outage occurs during operation, the unit recovers to the stopped status and aborts operation.

6. Maintenance procedures

Daily inspection/maintenance

Warning

- Be sure to pull out the power cord unless necessary before trying to do inspection and maintenance works.
- Start these works after the device has returned to the normal temperature.
- Never try to disassemble the unit.

Caution

- Wipe off any dirt with a tightly wrung soft cloth. Never try to clean the unit with benzene, thinner or scouring powder, or rub with a scrubbing brush. Deformation, degradation or discoloration may result.

Every month

- Inspect the functions of the ELB.
 - Test shall be performed with the power cord connected and power is being supplied to the unit.
 - First turn the ELB to “off.”
 - Then, turn the ELB “on” and press the test button on the device with a ball-point pen to check whether it is turned off to indicate that it is in the normal state.
- Check operation of the standalone overhear preventive device.
 - Carry out fixed temperature operation at an appropriate set temperature and then set the operating temperature of the standalone overhear preventive device to a temperature lower than that one by a few degrees (about 5°C).
 - If the device is normal, the heater circuit will be shut off in several seconds and, at the same time, the “Alarm” sign and Er07 come on and the alarm buzzer sounds.
- Clean the dust filter and the fins of the condenser.
 - Remove the filter frame of the front. (attached with magnets)
 - Pull out the filter out of the frame and remove dusts using an electric cleaner.
 - Remove dusts on the condenser fins using an electric cleaner.

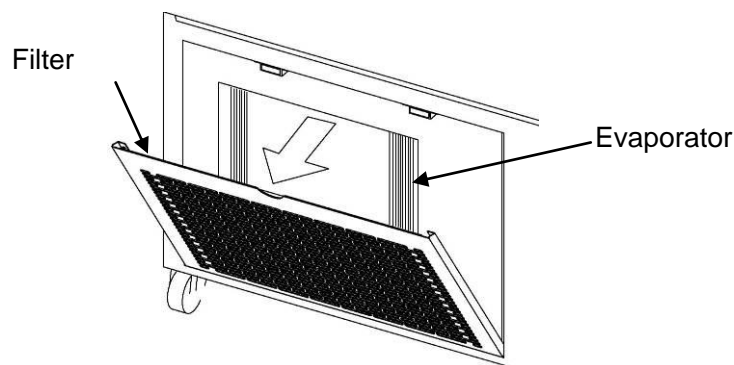

Caution

- When the condenser is clogged with dusts or foreign particles, degradation of its cooling capacity or a malfunction may result.
- During cleaning, take care not to crush condenser fins which are soft.
- Take care not to cut your finger with keen edges of the fins.

* Never fail to carry out checking of the ELB and operation of the overhear preventive device above prior to long-term continuous operation or unmanned operation during nighttime.

- ◆ If you have any questions, immediately contact your dealer, one of our sales offices or our general customer service center.

6. Maintenance procedures

Daily inspection/maintenance

When specimen spills over

- Clean the inside of the unit. If soil has extended to inside the rectifying board, remove the lower rectifying board and clean the inside.
 - Remove the rectifying boards at the lower part of the inside. They can be separated into front and rear parts. Remove screws and remove the front rectifying board as shown in the diagram below. If soil is extensive, remove the rear part and clean the inside.
 - Use well wrung out soft cloth to remove soil on the inside.

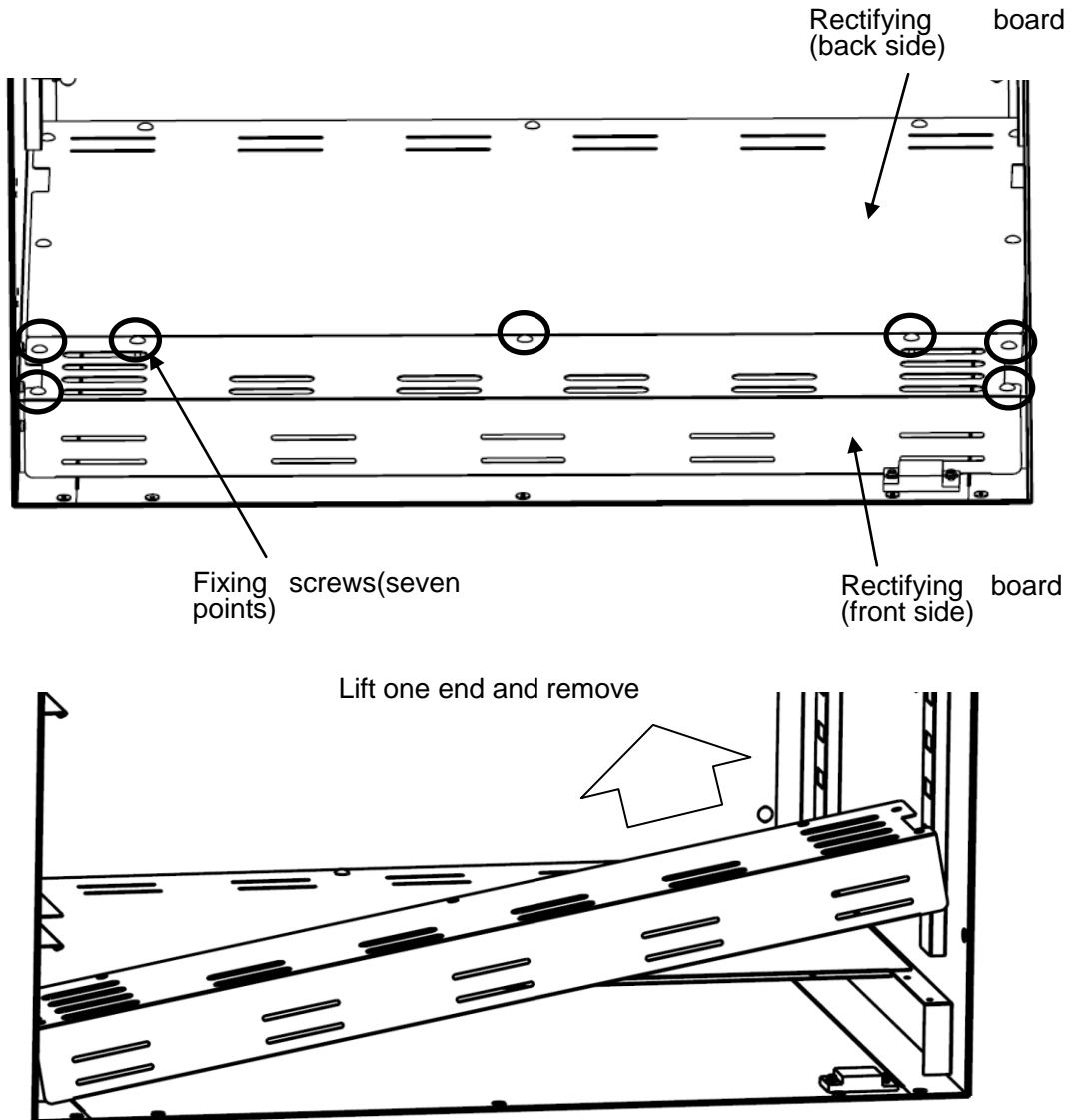



⚠ Caution

- If cleaning is not performed properly, some types of spilt specimen may cause contamination or other troubles.
- Take extreme care for handling of stainless steel plates.

- ◆ If you have any questions, immediately contact your dealer, one of our sales offices or our general customer service center.

7. When the unit is not to be used for a long time or when disposing

When the unit is not to be used for a long time or when disposing

 Warning	 Caution
<p>When the unit is not going to be used for a long time</p> <ul style="list-style-type: none"> ● Turn the power to off and pull out the power cord. 	<p>When disposing the unit</p> <ul style="list-style-type: none"> ● The Unit employs substitutive CFC. Ask disposal to a professional company. ● Do not leave the unit in the area where children may have access.

Notes about disposition

Always pay attention to the preservation of the global environment.

- We highly recommend taking the unit apart as far as possible for separation or recycling to contribute to the preservation of the global environment. Major components and materials for the unit are as follows:

Names of major parts	Material
Major components of the main unit	
External surface	Chrome free electrogalvanized steel plate Chemical-proof baking finish
Internal surface	Stainless steel plate
Heat insulator	Styrene foam
Boards	Polyethylene(PET) resin film
Major components of electric system	
Switch, relay	Composite of resin, copper and other materials
Operation panel	Polycarbonate resin
Boards	Composite of fiber glass and other materials
Heater	Iron chrome wire
Power cord	Composite of synthesized rubber coating, copper, nickel and other materials
Wire materials	Composite of fiber glass, fire-retardant vinyl, copper, nickel and other materials
Stickers	Resin materials
Sensor (Pt & K double sensor)	SUS304 stainless steel and other materials

8. When a trouble occurs

Safety device and error codes

The unit has the self diagnostic function with a controller and a separate safety device.

Table below shows possible causes and measures when the safety device is triggered.

[Error code]

When an error occurs to the unit, the buzzer sounds and operations stops.

The operation panel shows an error code. Check the error code, immediately turn power off and stop operation.

Error indication	Error name	Possible causes and measures
Er01	Sensor error	<ul style="list-style-type: none"> ● Error in the temperature input circuit ● Disconnection or other errors in the temperature sensor ● Measured temperature is outside the displayable range Contact our customer service center.
Er02	SSR short circuit	<ul style="list-style-type: none"> ● SSR short circuit Contact our customer service center.
Er03	Detection of heater disconnection	<ul style="list-style-type: none"> ● Heater disconnection Contact our customer service center.
Er04	Internal fan error	<ul style="list-style-type: none"> ● Disconnection of the internal fan ● Locking of the internal fan Contact our general customer service center.
Er07	Standalone overheat preventive device activated	<ul style="list-style-type: none"> ● Activation of overheat protector First reset the power supply and check the temperature in the bath and the set temperature for the overheat protector. If the unit does not reset, contact our customer service center.
Er10	Melted main relay contact	<ul style="list-style-type: none"> ● Main relay error Contact our general customer service center.
Er24	Inverter error	<ul style="list-style-type: none"> ● Refrigerator overload Tentatively turn power off, wait until the unit has sufficiently cools down and resume operation. When the environmental operating temperature exceeds 35°C, operate the unit at an environment of 35°C or lower. When the filter or the condenser is clogged, clean it following the instructions in "P60 6. Maintenance procedures". Contact our general customer service center if an error occurred again.
Er25	Refrigerator voltage error high	

8. When a trouble occurs

Troubleshooting

Symptom	Causes	Solutions
Power will not turn on even if the power switch is turned ON.	● Imperfect power supply of the user side	● Assure power supply to be AC100V±10%.
	● ELB error ● Power switch error	● Replace ● Replace
Temperature will not rise	● Placement of too many samples	● Do not cover over 70% of the total shelf board area.
	● Heater disconnection ● SSR error ● Temperature controller error	● Replace ● Replace ● Replace
Temperature will not decrease	● Placement of too many samples ● Operating environment temperature exceeds 35°C ● Condenser is clogged with dusts ● Too much frost on the evaporator	● Do not cover over 70% of the total shelf board area. ● Operating environmental temperature: 5~35°C ● Clean the condenser fins ● Defrost
	● Temperature sensor error ● Temperature controller error ● Relay error ● Imperfect power supply of the user side ● Refrigerator error	● Replace ● Replace ● Replace ● Prepare appropriate power supply ● Repair or replace
The heater will not turn OFF even if the set temperature is reached.	● SSR error ● Temperature controller error	● Replace ● Replace

When power outage occurred

When power supply to the unit has recovered after having stopped operation from a power outage, the unit will operate in either of two ways below depending on the setting you have selected.

- If recovery has been set, the unit will return to the status immediately before the power outage when power supply recovers. When power outage occurs during operation, the unit will recover to the operating status and continue operation.
- If recovery has not been set, the power key of the unit will shift to OFF status when the power supply recovers. When power outage occurs during operation, the unit recovers to the stopped status and aborts operation.

Reference : P31 Setting the recovery mode

9. After sales service and warranty

When requesting a repair

When requesting a repair

If any trouble occurs, immediately stop operation, turn the power switch off, pull out the power plug and contact your dealer, our sales office or our customer service center.

Information necessary for requesting a repair

- Model name of the product
 - Serial number
 - Date (y/m/d) of purchase
 - Description of trouble (as in detail as possible)
- } See the warranty card or the nameplate on the unit.
(See P.10) .

Be sure to indicate the warranty card to our service representative.

Warranty card (attached separately)

- Warranty card is given by your dealer or one of our sales offices and please fill in your dealer, date of purchase and other information and send it to our customer service center (described the number in the back cover) by Facsimile. Then, store it securely.
- Warranty period is one full year from the date of purchase. Repair service for free is available according to the conditions written on the warranty card.
- For repairs after the warranty period consult your dealer, one of our sales offices or our customer service center.
Paid repair service is available on your request when the product's functionality can be maintained by repair.

Minimum holding period of repair parts

The minimum holding period of repair parts for this product is seven years after end of production. Repair parts here refer to parts necessary for maintaining performance of the product.

10. Specifications

Model		INE800	
System		Forced blow circulation	
Operating temperature range *1		0°C~60°C	
Temp. control accuracy (at 37°C) *1		±0.2°C former JTM(continuous run at 37°C)	±0.3°C JIS Temp. fluctuation (continuous run at 37°C)
		±0.5°C former JTM(cycle run at 37°C)	±1.0°C JIS Temp. fluctuation (cycle run at 37°C)
Temp. distribution accuracy (at 37°C) *1		±0.5°C former JTM(continuous run at 37°C)	2.0°C JIS Temp. gradient (continuous run at 37°C)
Temp. attainment time *1	Max. temp.	20°C→60°C Approx. 35 minutes	
	Min. temp.	20°C→ 0°C Approx. 50 minutes	
Temp. control system		PID control	
Temp. setting system		Set temp. display : 5-digit amber LED digital display	
Temp. display system		Temp. display : 4-digit green LED digital display	
Timer		0min~99 hr 59min, un-limited	
Resolution of the timer		One minute	
Operating function		Fixed temperature operation: auto stop; auto start Program run (Max. 99 patterns, 99 steps, repeat)	
Additional functions		Integral time meter function, calibration offset function External communication function (RS485), temp. output terminal (4-20mA)	
Refrigerator		Rotary unit 200W	
Operating range of refrigerator		Setting 40°C or lower ※2	
Refrigerator refrigerant		R134a 350g	
Heater	Material	Iron chrome wire	
	Capacity	750W	
Blower fan		Axial fan	
Sensor		Pt100Ω (temp. controller), K-thermocouple(standalone overheat preventive device)	
Interior		Stainless steel plate	
Exterior		Chrome free electrogalvanized steel plate Chemical-proof baking finish	
Heat insulator		Styrene foam (non-Freon)	
Inner door		Reinforced glass (thickness:5 mm; two-part of upper and lower)	
Safety unit		Temp. sensor error, heater disconnection, SSR short-circuit, main relay error, internal fan error, refrigerator high voltage error, refrigerator discharge gas temperature error, inverter error, automatic overheat preventive function, key lock function, standalone overheat preventive device, overcurrent ELB	
Defrosting mechanism		Manual ON/auto OFF, auto defrost (time-dependent cycle or clock time)	
Cable port		I.D.:50 mm (right side of the main unit)	
Internal dimensions: W × D × H *3		600 × 477 × 1000 (effective size:800) mm	
External dimensions: W × D × H		710 × 645 × 1730 mm	
Inner capacity		286L	
Withstand load of shelf board		15 kg/board	
Number of shelf stages (pitch)		23 (30 mm)	
Power supply		AC100V 10A (ELB: 15A)	
Weight		Approx.135 kg	
Accessories	Shelf boards/shelf rails	Stainless steel punched metal 5 boards/10 rails	
	Others	Door key x 2, silicon plug x 1	
Optional accessories		External communication adaptor set(RS-485-USB conversion), external alarm terminal, shelf board set, time-up output terminal, anti-seismic clamps (anchor bolt hole: Φ11mm)	

*1 Performance has been measured at: power of AC100V; room temperature of 23°C±5°C; humidity of 65%RH±20%; and no load.

The recommended operating environmental temperature range:5°C~35°C.

*2 The refrigerator will turn OFF at a set temperature of 40.1°C or over. If you set cooling at a constant rate in the program run, the refrigerator will be OFF and cooling at a constant rate is disabled when the indicated temperature is 45°C or over and the set temperature is 40.1°C or over.

*3 Protrusions are excluded.

11. Wiring Diagram

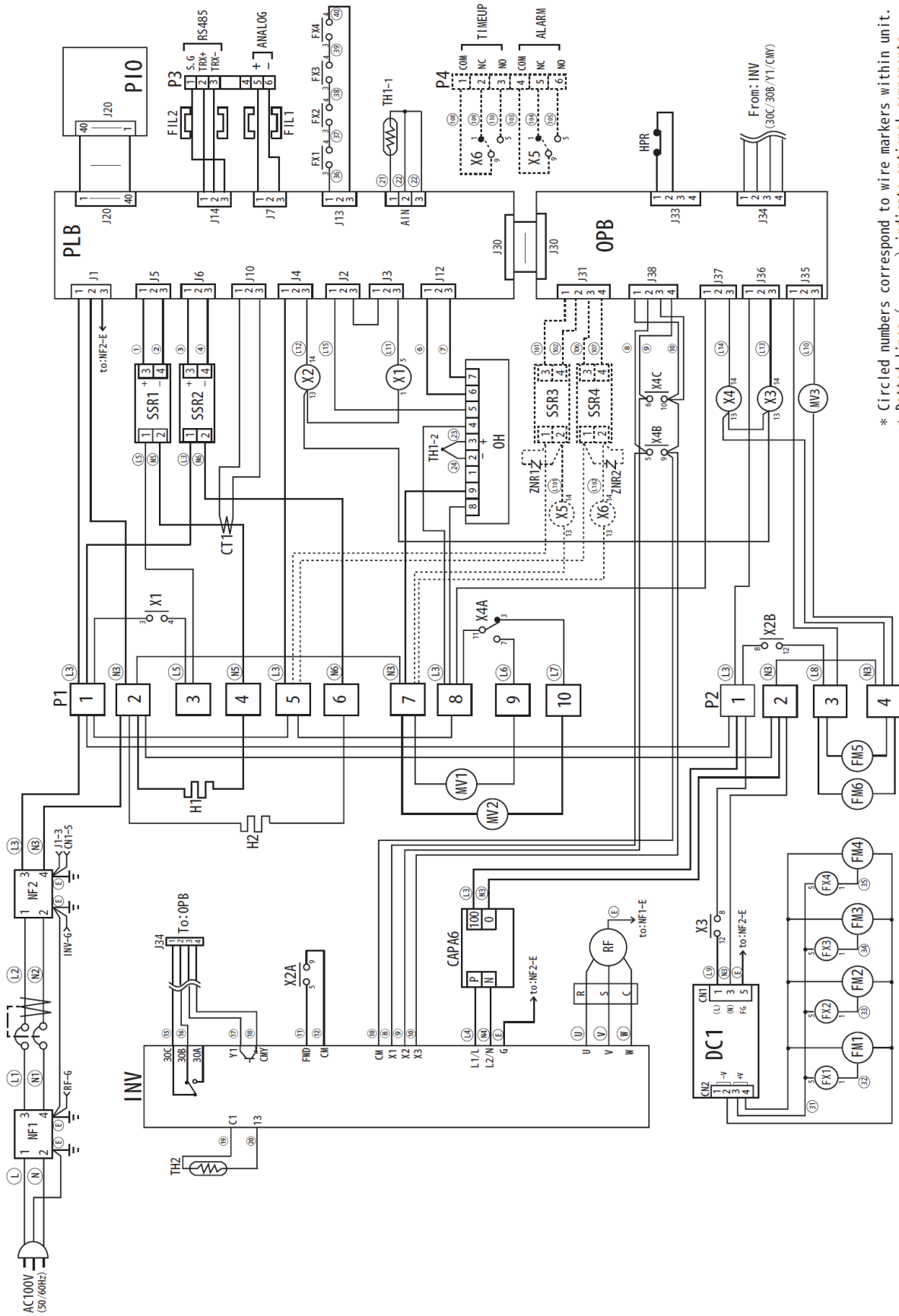

* Circled numbers correspond to wire markers within unit.
 * Dotted lines (-----) indicate optional components.

11. Wiring Diagram

Part symbols in the wiring diagram

Symbol	Name	Symbol	Name
NF 1 & 2	Noise filter	TH1	Temp. sensor (double sensor Pt & K)
ELB	Electric Leakage Breaker	TH2	Temp. sensor (thermistor)
P 1~3	Terminal block	OH	Standalone overheat preventive device
H1	Heater (inside)	SSR1	Solid state relay (main heater)
H2	Heater (door)	SSR2	Solid state relay (door heater)
FM1~4	Fan motor (inside)	PLB	Planar board
FM5	Fan motor (refrigerator)	PIO	Display board
FM6	Fan motor (inverter)	OPB	Option board
MV1	Solenoid valve (defrost)	CT1	Current sensor
MV2	Solenoid valve (return pipe)	DC1	DC24V power supply
MV3	Solenoid valve (injection)	HPR	High pressure relay
X1	Relay (internal heater)	CAPA6	Voltage doubler rectifier board
X2	Relay (refrigerator)	INV	Inverter
X3	Relay (internal fan)	RF	Refrigerator
X4	Relay (defrost)	FIL 1 & 2	Ferrite core
FX 1~4	Fan error detection relay		
Optional parts			
Symbol	Name	Symbol	Name
X5	Relay (external alarm)	SSR3	Solid state relay (external alarm)
X6	Relay (time-up)	SSR4	Solid state relay (time-up)
ZNR 1 & 2	Surge absorber	P4	Terminal block

12. List of replacement parts

Part name		Part code	Specifications	Maker
V planar board		LT00034911		Yamato
V PIO board		LT00034912		Yamato
V optional board		LT00034913		Yamato
Switching power supply		LT00036526	LGA50S-24	COSEL
Inverter		LT00035481	FRN0.75E1S-20A	Fuji
Rectifying circuit		LT00035482	CAPA6-0.75	Fuji
Relay	X2,3,5,6	LT00035031	RU2S-C-A100	IDEC
Socket	X2,3,5,6	LT00020610	SM2S-05DN	IDEC
Power relay	X1	LT00035479	RJ1S-CLR-A100	IDEC
Socket	x 1, FX1~4	LT00025916	SJ1S-05B	IDEC
Relay	x 4	LT00035356	RU4S-C-A100	IDEC
Socket	x 4	LT00034151	SY4S-05DN	IDEC
Fixing spring for relays	Common	LT00035320	SFA-503	IDEC
Terminal block		LT00035672	MKH-250ABC-4P	Terminal
Terminal block		LT00035676	MKH-250ABC-10P	Terminal
SSR		2160000035	TRS5225	Toho
Surge absorber		LT00033116	ERZV14D471	Panasonic
Current detection element		2170010002	CTL-6-S-4-H	URD
Noise filter	NF2	LT00035503	NAC-10-472	COSEL
Noise filter	NF1	LT00035504	NBC-10-472	
Ferrite core		LT00035505	ZCAT2436-1330A	TDK
Double sensor(Pt & K)		LT00001081	Pt&K	Yamato
ELB		LT00029774	NV-L22GR 15A	Mitsubishi
Refrigerator unit		LT00035476	UF-NR210MLV-YL	Yamato
Unit components	Refrigerator	/	80200470S	Sanyo
	Fan motor		80205310283000	
	Fan		80203401132004	
	Pressure switch		80203511365000	
	Dryer		81004004142001 D-SM032T	
	Capacitor		80203101418004	
	Accumulator		80203515187000	
Fan motor	For inverter	D0010138	MU925S-11	Oriental
Fan	for internal circulation	LT00035478	KLDC24Z7S	NIDEC SERVO
Fan error detection relay	FX1 ~4	LT00035616	RJ1S-C-D24	IDEC
Filter	For capacitor	INE8040000		Yamato
Magnet packing	For door	LT00032677	IN804-30030	Yamato
Cam lock	Door key	LT00000913	C-178-T	Takigen
Heater wire		IN045	IN81S-40590 AC100V/750W	Yamato
Cord heater		IB016	IN81S-40481	Yamato
Terminal block		LT00009399	MF10-4AX 6P with a cover	Toyo
INE800 Digital thermostat set		INE80S0100	PAS3K1A1-0B6 INE80-PAS3-P0100	Yamato
Solenoid valve		3020060003	SEV-502DXF	Saginomiya
Solenoid valve		3020060004	NEV-603DXF	Saginomiya
Charge valve		3250010002	FV222D0010C	Meiko
Accumulator		3230000001	SAC-154000	Yamato

13. List of dangerous materials



Never use an explosive substance a flammable substance or a substance containing them for this device.

Explosive substance	① Nitroglycol, glycerine trinitrate, cellulose nitrate and other explosive nitrate esters
	② Trinitrobenzen, trinitrotoluene, picric acid and other explosive nitro compounds
	③ Acetyl hydroperoxide, methyl ethyl ketone peroxide, benzoyl peroxide and other organic peroxides
	④ Metallic azide, including sodium azide, etc.
Flammable substances	Explosive substances
	① Metal "lithium" ② metal "potassium" ③ metal "natrium" ④ yellow phosphorus ⑤ phosphorus sulfide ⑥ red phosphorus ⑦ phosphorus sulfide ⑧ celluloids, calcium carbide (a.k.a, carbide) ⑨ lime phosphide ⑩ magnesium powder ⑪ aluminum powder ⑫ metal powder other than magnesium and aluminum powder ⑬ sodium dithionous acid (a.k.a., hydrosulphite)
	Oxidizing substances
	① Potassium chlorate, sodium chlorate, ammonium chlorate, and other chlorates
	② Potassium perchlorate, sodium perchlorate, ammonium perchlorate, and other perchlorates
	③ Potassium peroxide, sodium peroxide, barium peroxide, and other inorganic peroxides
	④ Potassium nitrate, sodium nitrate, ammonium nitrate, and other nitrates
	⑤ Sodium chlorite and other chlorites
	⑥ Calcium hypochlorite and other hypochlorites
	Flammable substances
	① Ethyl ether, gasoline, acetaldehyde, propylene chloride, carbon disulfide, and other substances with ignition point at a degree 30 or more degrees below zero.
	② n-hexane, ethylene oxide, acetone, benzene, methyl ethyl ketone and other substances with ignition point between 30 degrees below zero and less than zero.
	③ Methanol, ethanol, xylene, pentyl n-acetate, (a.k.a.amyl n-acetate) and other substances with ignition point between zero and less than 30 degrees.
④ Kerosene, light oil, terebinth oil, isopenthyl alcohol(a.k.a. isoamyl alcohol), acetic acid and other substances with ignition point between 30 degrees and less than 65 degrees.	
Combustible gas	
Hydrogen, acetylene, ethylene, methane, ethane, propane, butane and other gases combustible at 15°C at one air pressure.	

Excerpt from Table 1, Hazardous Substances, of the Cabinet Order of the Occupational Safety and Health Law (substances related to Articles 1, 6, and 9)

14. Standard installation manual

*Install the product according to the following: (Confirm separately for optional items or special specifications)

Model	Serial number	Date	Installation mgr. (company name)	Installation mgr.	Judgment

No.	Item	Implementation method	TOC No. Reference page of the operating instruction manual	Judgment
Specifications				
1	Accessories	Check for number of accessories on the basis of the column for accessories.	10. Specifications field P.66	
2	Installation	<ul style="list-style-type: none"> Visual check of environmental conditions Caution: Take care for environment 	2. Before operating the unit <ul style="list-style-type: none"> On the installation site P.4	
		<ul style="list-style-type: none"> Securing a space Installation of drain pan Installation of adjuster Installation of shelf board 	2. Before operating the unit <ul style="list-style-type: none"> Installation procedure P.4~7	
Operation-related matters				
1	Source voltage	<ul style="list-style-type: none"> Measure the user side voltage (distribution board, outlet, etc.) with a tester Measure voltage during operation (shall meet the specifications) Caution: Always use a plug that meets the specification for attaching to the ELB. 	2. Before operating the unit <ul style="list-style-type: none"> Be sure to connect the ground wire. Power supply.... 10. Specifications <ul style="list-style-type: none"> Specification-power supply P. 66	
2	Operation start	<ul style="list-style-type: none"> Start operation. 	2. Before operating the unit <ul style="list-style-type: none"> Installation procedures 4. Operating method P. 4~7 P.13~58	
Description				
1	Operational descriptions	Explain operations of each component according to the operational instructions	4. Operating method P.13~58 1. Safety precautions ~14. List of dangerous materials P. 1~70	
2	Error codes	Explain the customer about error codes and procedures for release according to the operational instructions	8. Troubleshooting ~9. After sales service and warranty P.63~65	
3	Maintenance and inspection	Explain operations of each component according to the operational instructions	6. Maintenance procedures <ul style="list-style-type: none"> Daily inspection/maintenance P. 60	
4	Completion of installation Entries	<ul style="list-style-type: none"> Fill in the installation date and the installation mgr. on the nameplate of the main unit Fill in necessary information to the warranty card and hand it over to the customer Explanation of the route for after-sales service 	9. After sales service and warranty P.65	

Limited liability

Be sure to use the unit strictly following the handling and operating instructions in this operating instruction.

Yamato Scientific Co., Ltd. assumes no responsibility for an accident or a malfunction caused by use of this product in any way not specified in this operating instruction.

Never attempt to perform matters prohibited in this operation instruction.

Otherwise, an unexpected accident may result.

Notice

- **Descriptions in this operating instruction are subject to change without notice.**
- **We will replace a manual with a missing page or paging disorder.**

Instruction Manual

Eco Incubator

INE 800

First edition December 13, 2011

Revised on December 27, 2013

Yamato Scientific Co., Ltd.

2-2-1 Nihonbashi Muromachi, Chuo-ku,

Tokyo, 103-0022, Japan

<http://www.yamato-net.co.j>

p