

SINCE 1889



INSTRUCTION MANUAL FOR GRAVITY CONVECTION OVENS

Model

DX302
DX402
DX602

Third edition

- Thank you very much for purchasing this Yamato DX series constant temperature drying oven.
 - Please read the “Operating Instructions” and “Warranty” before operating this unit to assure proper operation. After reading these documents, be sure to store them securely together with the “Warranty” at a handy place for future reference.
- ⚠ Warning!** Before operating the unit, be sure to read carefully and fully understand important warnings in the operating instructions.

Yamato Scientific America Inc.
Santa Clara, CA

Table of Contents

1. Safety precautions	1
Explanation of pictograms	1
List of symbols	2
Warning · Cautions	3
2. Before operating the unit	4
Precautions when installing the unit	4
3. Names and functions of parts	9
Main body	9
Operation panel	10
Explanation of characters	11
4. Operating procedures	12
List of operation modes and functions	12
Operation mode · function setting keys and characters	14
Operating procedures (settings for Standalone overheat prevention device (Thermostat))	15
Operating procedures (fixed temperature operation)	16
Operating procedures (quick auto stop operation)	17
Operating procedures (auto stop operation)	19
Operating procedures (auto start operation)	21
Useful functions (calibration offset function)	23
Useful function (setting lock function)	24
Useful function (power outage compensation function)	25
5. Cautions on handling	26
6. Maintenance procedures	28
Daily inspection/maintenance	28
7. When the unit is not to be used for a long time or when disposing	29
When the unit is not to be used for a long time or when disposing	29
Notes about disposition	29
8. Troubleshooting	30
Safety device and error codes	30
When a malfunction is suspected	31
9. After sales service and warranty	32
When requesting a repair	32
10. Specifications	33
11. Wiring diagram	34
12. List of replacement parts	35
13. List of dangerous materials	36
14. Standard installation manual	37



1. Safety precautions

Explanation of pictograms

About pictograms

A variety of pictograms are indicated in this operating instruction and on products to assure safe operation. Possible results from improper operation ignoring them are classified as follows.

Be sure to fully understand the descriptions below before proceeding to the text.

	Warning	Indicates a situation which may result in death or serious injury (Note 1)
	Caution	Indicates a situation which may result in minor injury (Note 2) and property damage (Note 3).

(Note 1) Serious injury means a wound, an electrical shock, a bone fracture or intoxication that may leave after effects or require hospitalization or outpatient visits for a long time.

(Note 2) Minor injury means a wound or an electrical shock that does not require hospitalization or outpatient visits for a long time.

(Note 3) Property damage means damage to facilities, devices and buildings or other properties.

Meanings of pictograms

 This pictogram indicates a matter that encourages the user to adhere to warning ("caution" included).
Specific description of warning is indicated near this pictogram.

 This pictogram indicates prohibitions
Specific prohibition is indicated near this pictogram.

 This pictogram indicates matters that the user must perform.
Specific instruction is indicated near this pictogram.

1.Safety precautions

List of symbols

Warning



General warnings



Danger!:
High voltage



Danger!:
High temperature



Danger!:
Moving part



Danger!:Hazard of
explosion

Caution



General cautions



Electrical shock!



Burning!



Caution for no
liquid heating!



Caution for water
leak!



For water only



Poisonous
material

Prohibitions



General bans



Fire ban



Do not
disassemble



Do not touch

Compulsions



General
compulsions



Connect ground
wire



Install levelly



Pull out the power
plug



Regular
inspection

1. Safety precautions

Warning · Cautions

Warning



Never operate the unit in an atmosphere containing flammable or explosive gas

Never operate the unit in an atmosphere containing flammable or explosive gas. Otherwise, an explosion or a fire may result since the unit is not explosion-proof. See section "Never operate the unit in an atmosphere containing flammable or explosive gas. Otherwise, an explosion or a fire may result since the unit is not explosion-proof." See section "13. List of dangerous materials" on page 36.



Be sure to connect the ground wire.

Be sure to connect the ground wire correctly. Otherwise, electrical leak may result and cause an electrical shock or a fire.



Ban on operation when an abnormality occurs

When a smoke or an unusual odor is seen or sensed, immediately turn the power switch on the main unit off and pull out the power cord (plug) from the power supply. A fire or an electrical shock may result.



Never use electrical power cords bundled.

When these are used bundled, they might overheat causing a fire.



Take care not to damage electrical power cords.

Avoid tightly bend, pull with a strong force or twist to prevent electrical power cords from damaging. A fire or an electrical shock may result.



Never use an explosive or a flammable material with this unit.

Never use an explosive material, a flammable material or a material containing them. An explosion or an electrical shock may result. See section "13. List of dangerous materials" on page 36.



Never try to touch a hot part.

Some parts of the unit are hot during and immediately after operation. Take special care for possible burning.



Never try to disassemble or alter the unit.

Never try to disassemble or alter the unit. A malfunction, a fire or an electrical shock may result.



Caution



When a thunder is heard.

When a thunder is heard, turn the main power off immediately. A malfunction, fire or an electrical shock may result.

2. Before operating the unit

Precautions when installing the unit

1. Carefully select an installation site.



Take special care not to install the unit at a place described below:

- On uneven or dirty floor
- Where combustible gas or corrosive gas exists
- Where the ambient temperature is 35°C or more
- Where temperature fluctuates widely
- Where dust or humidity is excessive
- Where subject to direct sunlight
- Where vibration is severe



Install this unit at a place with spaces shown below.

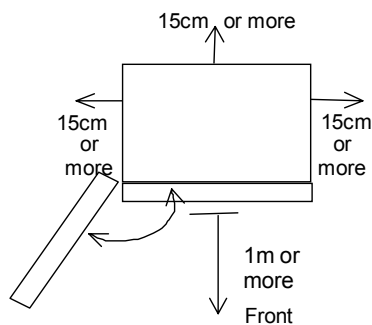

2. Never operate the unit in an atmosphere containing explosive or flammable gas



Never operate the unit in an atmosphere containing flammable or explosive gas. Since the unit is not explosion-proof, an arc is discharged when turning a switch “ON” and “OFF” and during operation and a fire or an explosion may result.



See the section “13. List of dangerous materials” on page 36 for flammable and explosive gases.

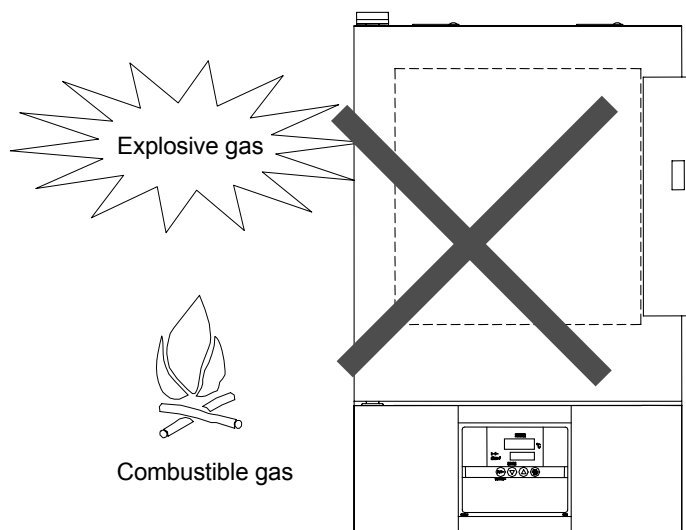

2. Before operating the unit

Precautions when installing the unit

3. Never use the unit with an explosive material, a flammable material or a material containing them.

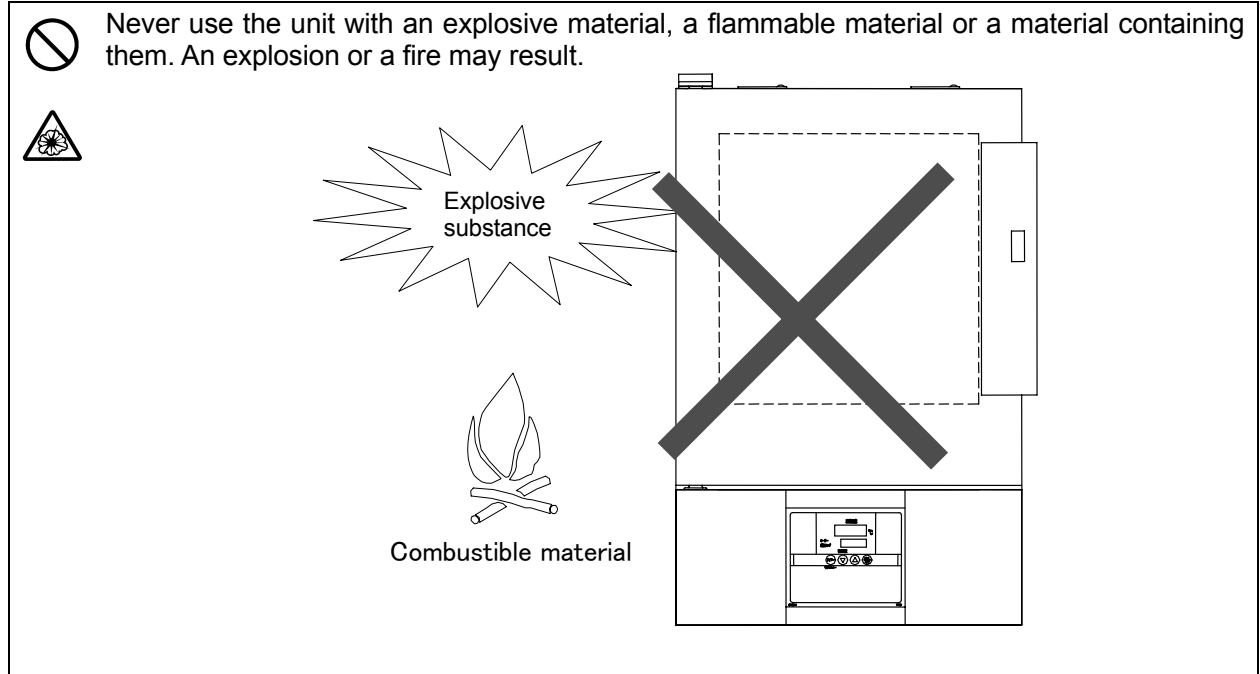

4. Do not alter the product.

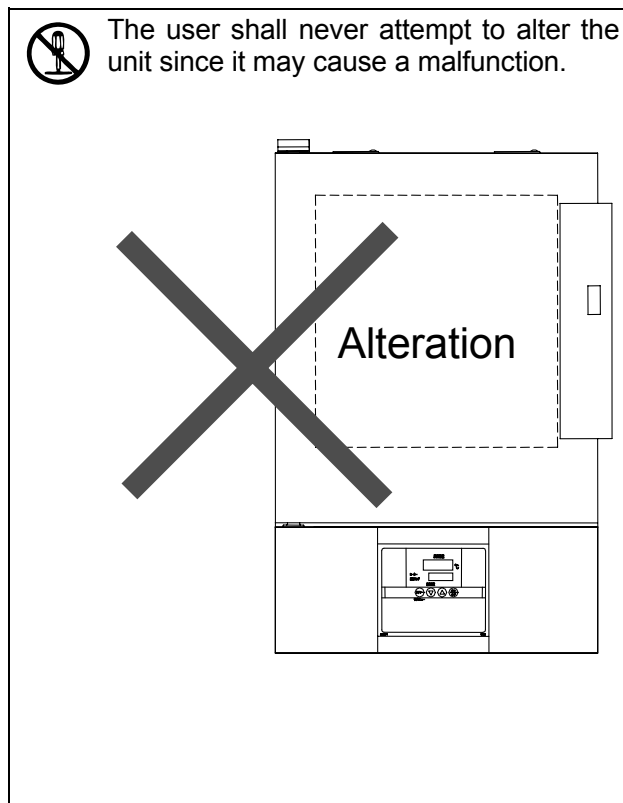

5. Install the unit on a level surface

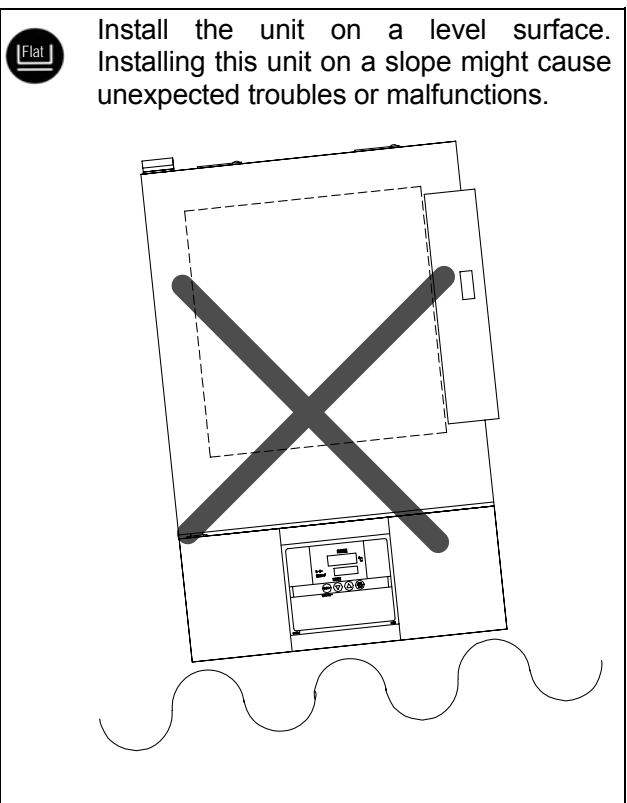

2. Before operating the unit

Precautions when installing the unit

6. Do not overload shelves.

- ⊘ Withstand load of each shelf board is 15kg in uniform loading. Place samples in a dispersed fashion.

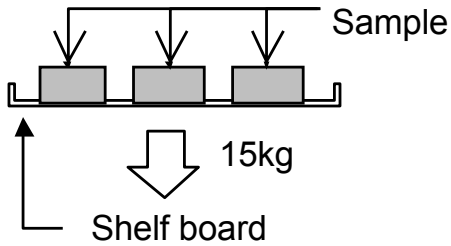

7. Do not place too many samples.

- ⊘ Too many samples may prevent proper temperature control. Be sure to use shelf boards and place samples apart each other so as to make free space of 30% or more to assure proper temperature accuracy.

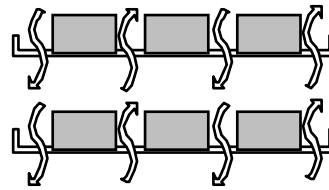

Make at least 30% of space

8. Installation

- ⚠ The unit might fall down or move by an earthquake or an impact resulting a personal injury. We recommend to make safety measures such as to avoid installing the unit at a place other than busy places. Take appropriate safety measures to prevent the unit from tripping over.

9. Placing shelf boards and samples

- ⚠ Two shelf boards are included with this product. One of them has been fixed on the lowest stage of the shelf pillar of the internal chamber at the time of shipping from the factory. Set another board to an appropriate position in the chamber. A heater is installed under the flow adjusting board. Thus, the temperature of the flow adjusting board and around it is always higher than the set temperature and placing a sample directly on the board may damage it or cause a fire. Therefore, the shelf board is fixed with screws as shown to disable direct placement of samples. Because of the shape of samples, when the unit is operated with shelf boards removed to accept them, assure sufficient space between them and the flow adjusting board and never place samples directly on the board.

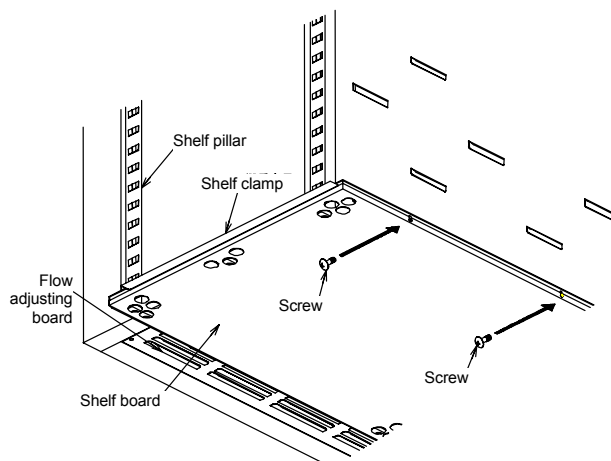

2. Before operating the unit

Precautions when installing the unit

10. Always operate the unit with the vent holes open.



Do not cover the vent holes on the top panel of the unit.
Adjust the open amount according to the water content of a specific sample.

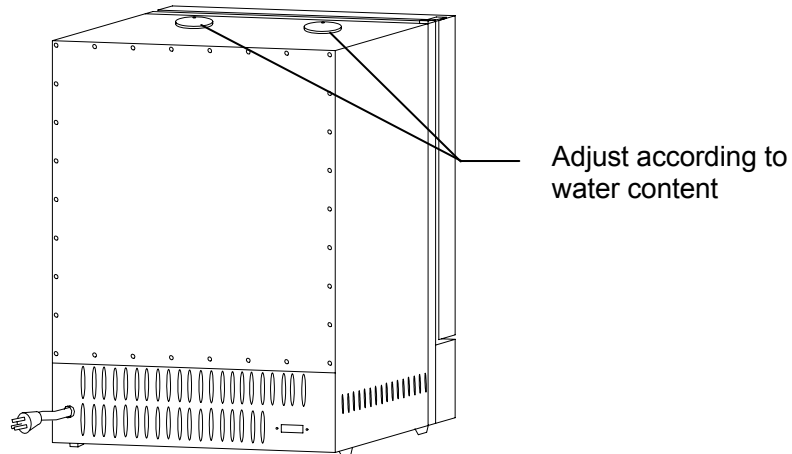

11. Be sure to connect the power plug to the dedicated power distribution panel or a wall outlet.

Use a power distribution panel or a wall outlet that meets the electrical capacity of the unit.

Electrical	DX302	AC115V	8.5A
capacity:	DX402	AC115V	13.5A
	DX602	AC115V	13.5A

- * When the unit will not start even when you turn the earth leakage breaker to "ON", check for low main voltage or if the unit is connected to the same power supply line as other devices and connect it to another line if necessary.

Avoid connecting too many devices using a branching outlet or extending a wire with a cord reel or temperature controlling function may degrade due to voltage drop.



Do not connect the unit to any parts or lines other than a correct power supply line such as a gas pipe, a water pipe or a telephone line.
Otherwise, an accident or a malfunction may result.

2. Before operating the unit

Precautions when installing the unit

12. Handling of a power cord

⊘ Never use electrical power cords bundled. When these are used bundled, they might overheat causing a fire.

Do not convert, forcibly bend, twist or pull the power cord. Otherwise, a fire or an electrical shock may result.

Do not place the power cord under a desk or a chair, or sand between objects to avoid it from being damaged. Otherwise, a fire or an electrical shock may result.

Do not place the power cord close to a stove or other heat generating device. Sheath of the cord may burn and result in a fire or an electrical shock.

! If the power cord should be damaged (exposure of core wire or disconnection), immediately turn the main unit off, pull out the power cord (plug) out of the power supply and ask your dealer to replace the cord. Otherwise, a fire or an electrical shock may result.

! Connect the power cord to an appropriate wall outlet.

13. Be sure to connect the ground wire.

- ⚡ When there is no ground terminal available, class D grounding work is necessary and please consult your dealer or our nearest sales office.
- ! Be sure to connect the ground wire to the wall outlet securely.

We recommend use of a ground type outlet When a bipolar type outlet tap is used
tap.

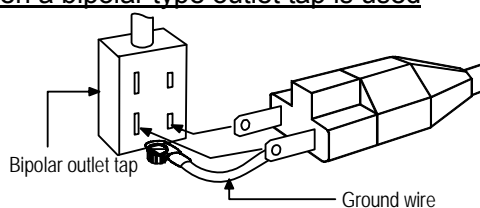
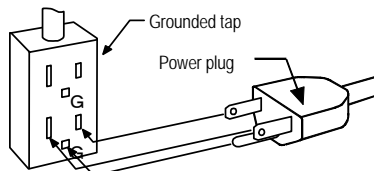

When there is no ground terminal.

In this case, class D grounding work is necessary and please consult your dealer or our nearest sales office.

Insert the ground adaptor included as an option, into a power plug confirming the polarity of the outlet. Connect the grounding wire (green) of the ground adaptor to the ground terminal on the power supply equipment.

⊘ Never connect the ground wire to anything other than the ground terminal such as gas pipe, water pipe, or telephone line. Otherwise, an accident or a malfunction may result.

14. When you operate the unit for the first time

! When you operate the unit for the first time at a higher temperature, the unit may generate an odor. This is due to decomposed bonding material contained in heat-insulation material and is not a malfunction of the unit. We recommend operating the unit at the highest temperature once before starting its regular operation.

3. Names and functions of parts

Main body

Front panel

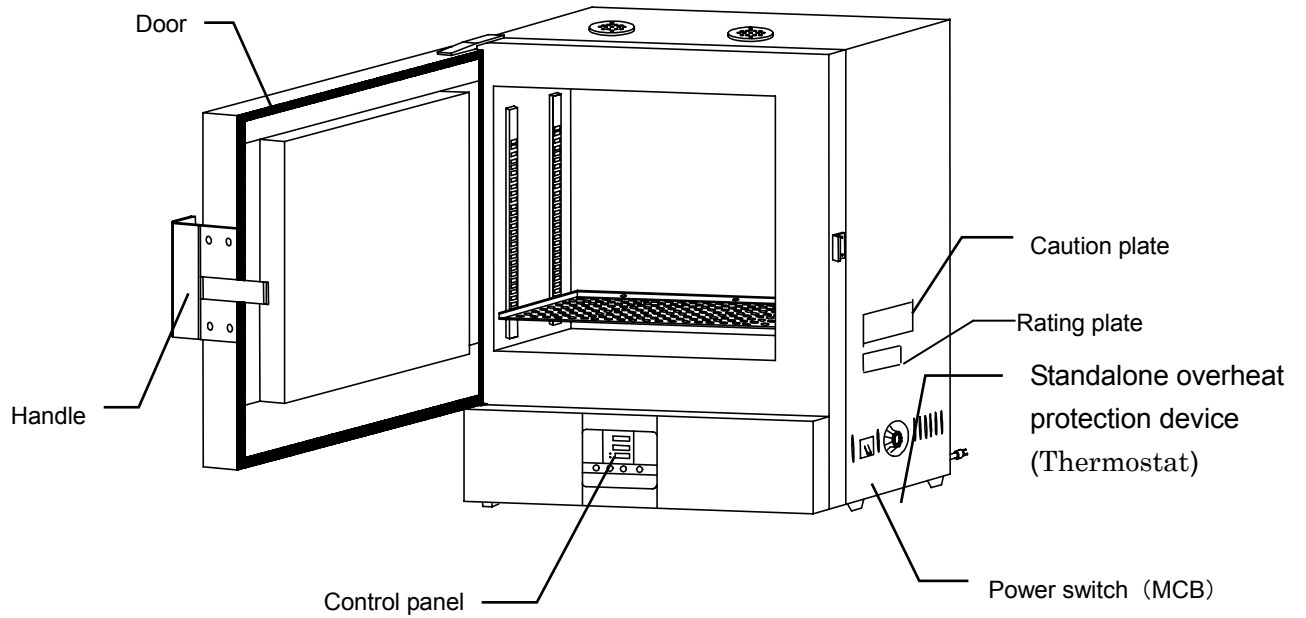

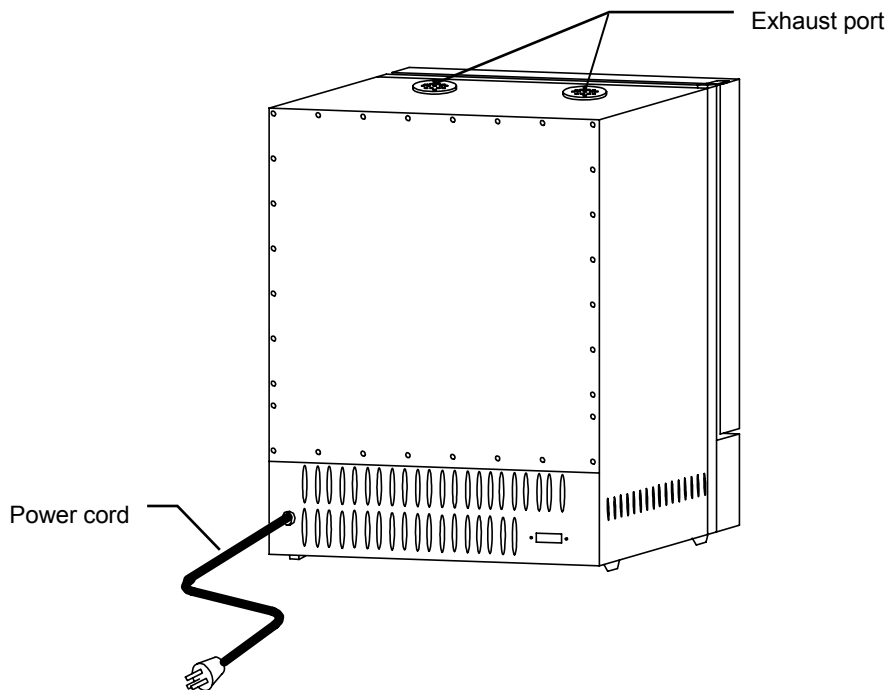

Rear panel

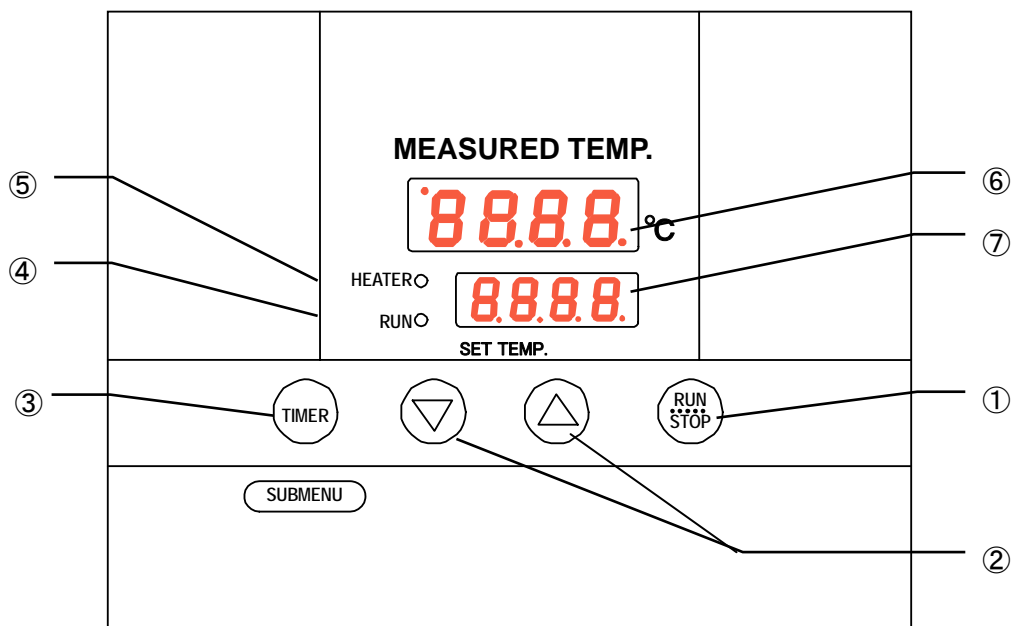

3. Names and functions of parts

Operation panel









No.	Name	Operation/action
①	RUN/STOP key	Used for starting/stopping operation.
②	▼▲ keys	Used for selecting settings.
③	TIMER key	Key for selecting timer operation settings. Quick auto stop operation, auto stop operation or auto start operation can be selected.
	SUB MENU key (Long press of the  key)	Key for setting calibration offset temperature, the key lock function or the power outage compensation function.
④	RUN lamp	Illuminates during fixed temperature operation and blinks during timer operation.
⑤	HEATER lamp	Illuminates while heater power is on.
⑥	Measured temperature screen	Displays measured temperature in the chamber · set characters · alarm information.
⑦	Set temperature screen	Displays a set temperature, timer settings and timer remaining time.

3. Names and functions of parts

Explanation of characters

Characters on the controller are explained in this section.

Characters	Identifier	Name	Application
	AStP	Auto stop setting	Used for setting auto stop operation.
	AStr	Auto start setting	Used for setting auto start operation.
	End	Time up	Displayed when timer operation has ended. See pages 17 and 19.
	cAL	Calibration offset setting	Used for inputting a calibration offset temperature See section "Using the calibration offset function" on page 23.
	Lock	Key lock of settings	Key locks settings to prevent their alteration See section "Using the lock function" on page 24.
	Pon	Power outage compensation setting	Selects operations after recovery from power outage. See section "Using the power outage compensation function" on page 25.

*See the section "Operation mode · function setting keys and characters" on page 14 for characters of operation modes and functions.

4. Operating procedures

List of operation modes and functions

Operation modes of the unit are as shown below:

No.	Name	Description	Page
1	Fixed temperature operation	Turning the MCB on to enter the operation setting mode. Proceed to temperature setting that uses ▼▲ keys. Pressing the RUN/STOP key longer to start operation, and pressing the RUN/STOP key longer again to stop operation.	P.16
2	Quick auto stop operation	Used when you want to “stop fixed temperature operation being performed automatically in several hours.” Press the TIMER key during fixed temperature operation to display “AStP.” Set a duration before stop with the ▼▲ keys. Pressing the RUN/STOP key starts quick auto stop operation and activates the timer in the middle of it to automatically stop it after the set period of time.	P.17
3	Auto stop operation	Used when you want to “set automatic stop for fixed temperature operation when making settings for it.” Press the TIMER key to display “AStP.” Set a duration before stop with the ▼▲ keys. Pressing the RUN/STOP key starts auto stop operation.	P.19
4	Auto start operation	Used when you want to “start operation automatically after several hours” after power is turned on. Press the TIMER key to display “AStr.” Set a duration before stop with the ▼▲ keys. Pressing the RUN/STOP key starts auto start operation.	P.21
* Operation mode cannot be changed while the unit is in operation. First stop operation before changing the mode.			

4. Operating procedures

List of operation modes and functions

Functions of the unit are as shown below:

No.	Name	Description	Page
1	Overheat prevention function	<p>Automatic overheat prevention function: This function is linked to the unit set temperature and has been set to so that it is automatically activated (returned automatically) at a temperature 12°C higher than the set temperature in the chamber.</p> <p>Standalone overheat protection device (Thermostat) : When the temperature in the chamber reaches the set temperature of the standalone overheat protection device (Thermostat), its heater circuit trips to shut off controller operation. The temperature can be set with the manual dial on the hydraulic overheat prevention device installed at the right side of the unit.</p>	P.15
2	Calibration Offset function	<p>Calibration offset function compensates any differences between the target temperature in the chamber and the control temperature of the controller (sensor temperature.) The function can compensate to either plus or minus side for the whole temperature band of the unit. This compensation can be set with the SUB MENU keys.</p>	P.23
3	Setting lock function	<p>This function locks the set operation status. The lock can be set or released with the SUB MENU key.</p>	P.24
4	Power outage compensation function	<p>This function returns the main unit operation to the resume status after recovery from power outage, or keeps the current stop status. This compensation can be set with the SUB MENU keys.</p>	P.25

4. Operating procedures

Operation mode · function setting keys and characters

Key operations and characters in the diagram below are used for operation mode and function settings.

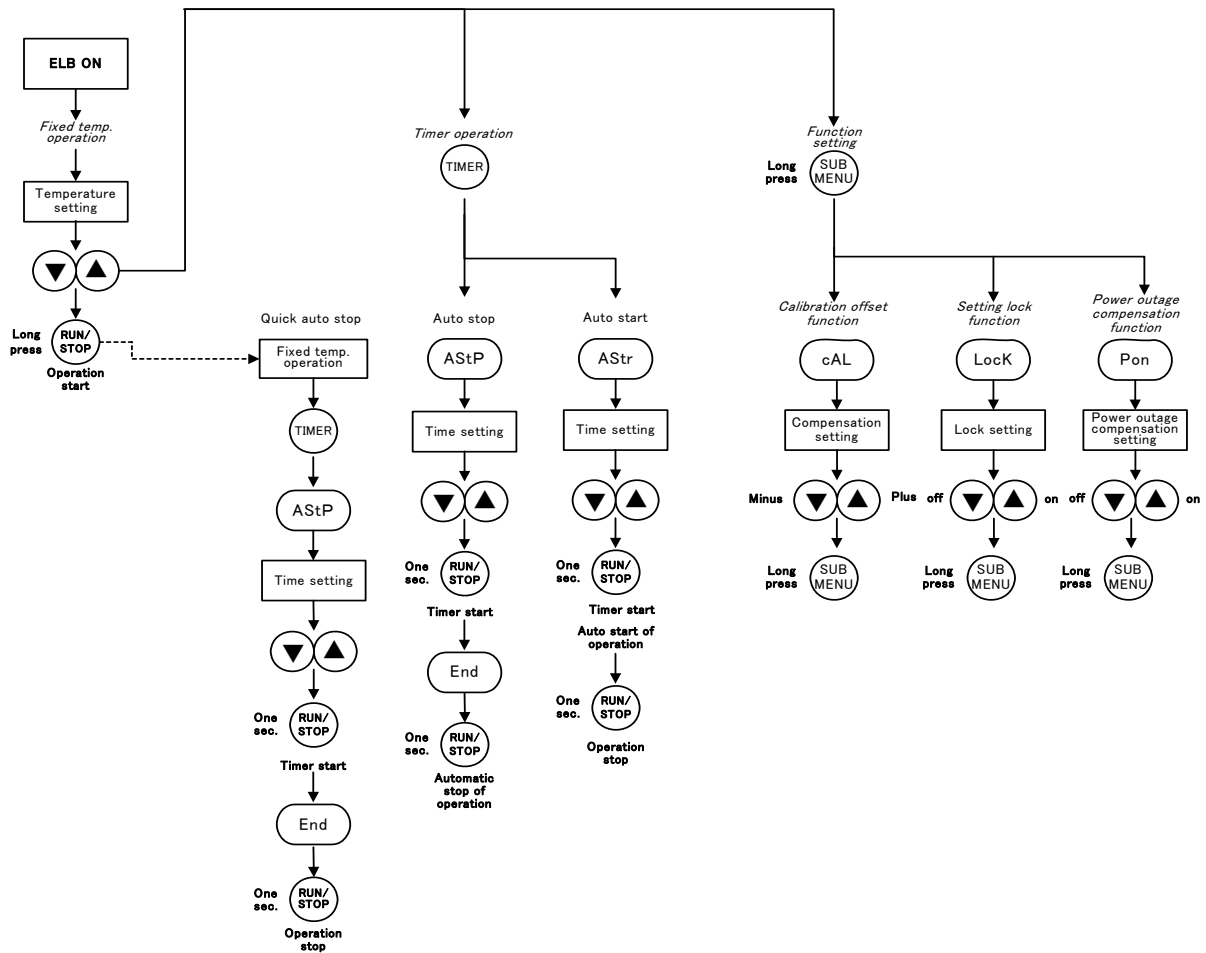

4. Operating procedures

Operating procedures (settings for Standalone overhear prevention device (Thermostat))

As a safety measure for preventing overhear, a standalone overhear prevention device (Thermostat) hydraulic overhear prevention device (manual return) is installed.

Temperature setting range and functions

The temperature setting range for the standalone overhear prevention device (Thermostat) is “50℃～350℃.”

When the temperature in the chamber keeps rising beyond the controller set temperature and reaches the set temperature of the standalone overhear prevention device (Thermostat), the heater circuit trips and the controller operation is shut off.

When the standalone overhear prevention device (Thermostat) is activated, it will not be released until the ELB is turned on.

How to set temperature

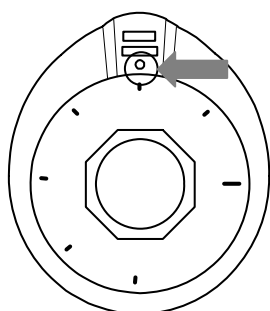

Set the temperature scale
to the arrow

Setting the standalone overhear prevention device (Thermostat)

- Set the temperature scale on the standalone overhear prevention device (Thermostat) installed on the right side of the unit to the arrow in the diagram shown left.
- Turn the ELB to “OFF” and wait for a while without opening the door.
- After a while, turn the ELB “ON.” (Turn the ELB “ON”.)

Caution

- ① Set temperature as “set temperature +20℃” as a rough standard and add 5℃ to the setting if the device functions improperly.
- ② The temperature setting range for the standalone overhear prevention device is “50℃～320℃.” Be sure to set the overhear prevention activation temperature correctly otherwise the device may not start, the overhear prevention device is activated before temperature in the chamber increases completely, or a fire or other unexpected accidents may result.
The temperature is set at 320℃ on shipping from the factory.
- ③ The standalone overhear prevention device (Thermostat) has been designed to prevent overheating of devices not to protect samples. The device does not prevent accidents caused from use of explosive or flammable materials.

4. Operating procedures

Operating procedures (fixed temperature operation)

How to start fixed temperature operation

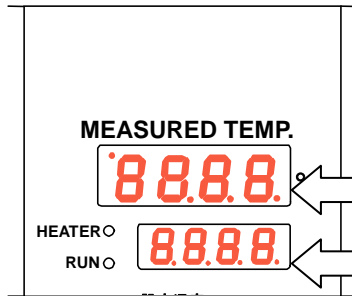

1. Turn the MCB ON. (Turn the MCB to “ON.”)

When the MCB is turned ON, the initial values will be displayed for about four seconds, then the initial screen will appear and the current chamber temperature and the previous set temperature are displayed on each of the indicators.

Measured temperature screen: Displays the current chamber temperature

Set temperature screen: Displays the previous set temperature

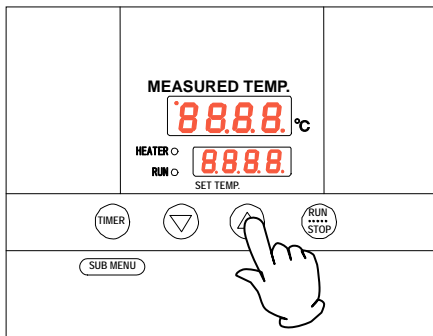

2. Setting the temperature

Set a temperature using the ▼▲ keys.

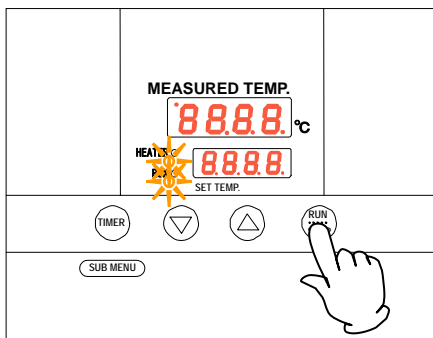

3. Starting operation

Press the **RUN/STOP** key longer.

Fixed value operation will start and the RUN lamp and the HEATER lamp come on.

4. Stopping operation

Press the **RUN/STOP** key longer.

Operation stops, the RUN lamp goes off and the screen switches to the initial setting screen.

When you want to correct setting errors or change settings

When you want to change settings, press the ▼▲ keys on the current screen to enter the setting mode where you can change settings. Blink stops three seconds after three seconds after change and setting is completed.



Caution

- ① When you want to lower the set temperature during fixed temperature operation, note that it takes some time to reach the reset temperature since the unit has no cooling capacity.
- ② Immediately after operation has been stopped, the temperature in the chamber is around the set temperature. Operation stop refers only to machine stop and time needed for decreasing the temperature in the chamber is not considered.

4. Operating procedures

Operating procedures (quick auto stop operation)

Used when you want to “stop fixed temperature operation being performed automatically in several hours. Quick auto stop operation is a function to enable auto stop timer setting during operation.

Procedures for quick auto stop operation

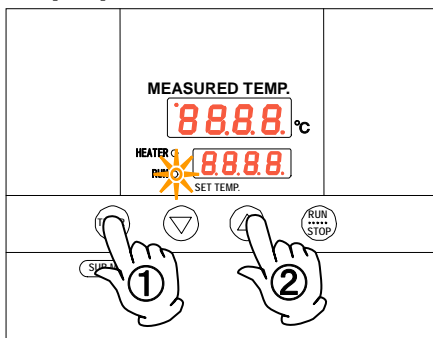

1. Setting time period before stop during fixed temperature operation

① Make sure that the RUN lamp is illuminated to indicate the unit is in operation.

Press the **TIMER** key.

Characters **ASTP** are indicated on the measured temperature screen to indicate the auto stop operation mode and set duration blinks on the set temperature screen.

② Set a duration you want using the **▼▲** keys.

About the timer function

The maximum time that can be set for the timer is 999 hours 50 minutes.

Up to 99 hours 59 minutes, time can be set in minutes.

One hundred hours and over are set only in 10 minutes.

Keep the **▼▲** keys pressed to continuously change set time and you can quickly reach the time you want. Press the **▼▲** keys once at a time for fine adjustment.

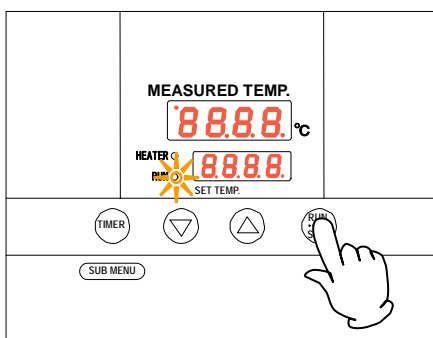

2. Starting timer operation

When the time you want is set, press the **RUN/STOP** key while the set temperature screen is blinking.

The RUN lamp blinks and timer operation is started.

Timer starts counting when the temperature in the chamber reaches the set temperature.

Once timer counting is started, the set temperature screen changes to the remaining time display.

3. Stopping and ending timer operation

Operation stops automatically when the set temperature has elapsed.

Characters **End** blink on the set temperature screen to indicate operation has ended.

Press the **RUN/STOP** key for approx. one second to end the timer operation mode. The screen switches to the initial setting screen.

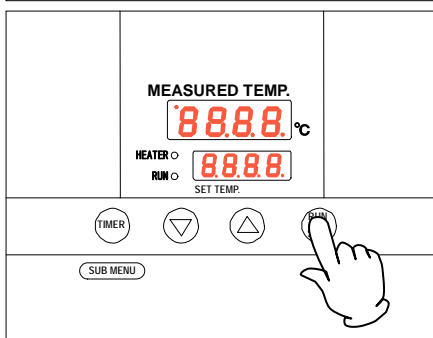

4. Operating procedures

Operating procedures (quick auto stop operation)

When you want to correct set temperature or set time, or change settings

When you want to change settings, press the ▼▲ keys on the current screen to enter the setting mode where you can change settings. Blinking stops three seconds after three seconds after change and setting is completed. Note, however, that temperature changes after timer activation are counted also while temperature is changing.

When you want to change settings before timer activation, press the **TIMER** key on the current screen to enter the setting mode where you can change settings. Enter a time duration from when the set temperature is reached to the time the device shall be stopped.

When you want to change settings after timer activation, press the **TIMER** key on the current screen to enter the setting mode where you can change settings. Note, however, you need to set a time calculated by adding the time already passed to the time to be added.

After change has been made, press the **RUN/STOP** key to complete the process.

When you want to stop quick auto stop operation in the middle of it, press the **RUN/STOP** key long once to stop device control once, then make settings again in the appropriate mode.

In terms of the remaining time display **1.30** a blinking dot indicates count down and an illuminating dot indicates a wait status (while temperature is increasing or decreasing to the set temperature) during which the timer has stopped counting.

4. Operating procedures

Operating procedures (auto stop operation)

This mode automatically stops fixed temperature operation after a certain time from its start set with the timer.

Procedures for auto stop operation

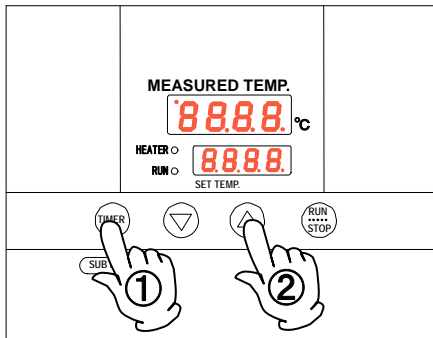

1. Setting a stop time

① After confirming the temperature you want is set, Press the **TIMER** key to display characters **AStP** **85tP** on the measured temperature screen that indicate auto stop operation.

The set time is displayed on the set temperature screen.

② Set a time you want using the **▼▲** keys. Pressing the **▼▲** keys makes the set time blink. The time is determined when blinking stops.

About the timer function

The maximum time that can be set for the timer is 999 hours 50 minutes.

Up to 99 hours 59 minutes, time can be set in minutes.

One hundred hours and over are set only in 10 minutes.

Keep the **▼▲** keys pressed to continuously change set time and you can quickly reach the time you want. Press the **▼▲** keys once at a time for fine adjustment.

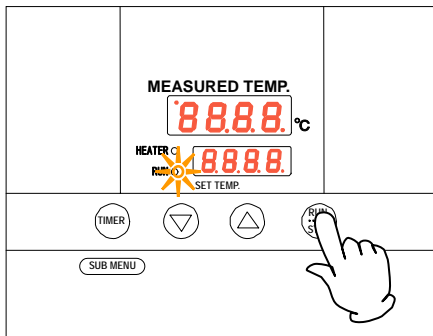

2. Starting timer operation

When the time you want is set, press the **RUN/STOP** key for about one second while characters **AStP** **85tP** that indicate auto stop operation are displayed on the measured temperature screen and the set time on the set temperature screen.

The **RUN** lamp blinks and timer operation is started.

Timer starts counting when the temperature in the chamber reaches the set temperature.

Once timer counting is started, the set temperature screen changes to the remaining time display.

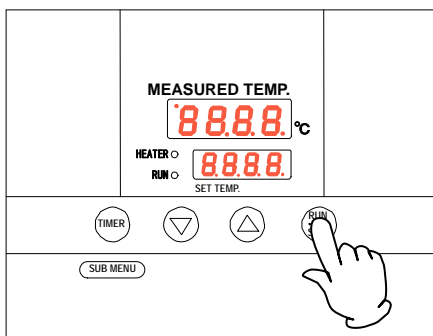

3. Stopping and ending timer operation

Operation stops automatically when the set temperature has elapsed.

Characters **End** **End** blink on the set temperature screen to indicate operation has ended.

Press the **RUN/STOP** key for approx. one second to end the timer operation mode. The screen switches to the initial setting screen.

4. Operating procedures

Operating procedures (auto stop operation)

When you want to correct set temperature or set time, or change settings

When you want to change settings, press the ▼▲ keys on the current screen to enter the setting mode where you can change settings. Blinking stops three seconds after three seconds after change and setting is completed. Note, however, that temperature changes after timer activation are counted also while temperature is changing.

When you want to change settings before timer activation, press the **TIMER** key on the current screen to enter the setting mode where you can change settings. Enter a time duration from when the set temperature is reached to the time the device shall be stopped.

When you want to change settings after timer activation, press the **TIMER** key on the current screen to enter the setting mode where you can change settings. Note, however, you need to set a time calculated by adding the time already passed to the time to be added.

After change has been made, press the **RUN/STOP** key to complete the process.

Auto stop operation is not available together with auto start operation.

When you want to stop auto stop operation in the middle of it, press the **RUN/STOP** key long once to stop device control once, then make settings again in the appropriate mode.

In terms of the remaining time display **1.30** a blinking dot indicates count down and an illuminating dot indicates a wait status (while temperature is increasing or decreasing to the set temperature) during which the timer has stopped counting.

4. Operating procedures

Operating procedures (auto start operation)

This mode automatically starts fixed value operation after a certain time from its start set with the timer.

However, operation does not stop automatically but needs to be stopped manually.

Procedures for auto start operation

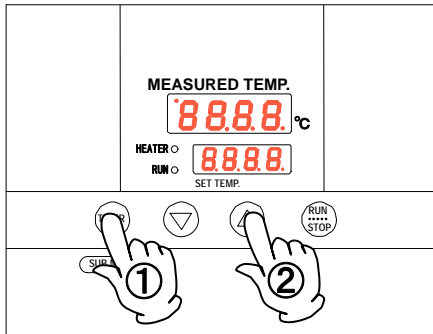

1. Setting an operation start time

- ① After confirming the temperature you want is set, Press the **TIMER** key to display characters AStr **AStr** on the measured temperature screen that indicate auto start operation. The set time is displayed blinking on the set temperature screen.
- ② Set a time you want using the **▼▲** keys. Pressing the **▼▲** keys makes the set time blink. The time is determined when blinking stops.

About the timer function

The maximum time that can be set for the timer is 999 hours 50 minutes.

Up to 99 hours 59 minutes, time can be set in minutes.

One hundred hours and over are set only in 10 minutes.

Keep the **▼▲** keys pressed to continuously change set time and you can quickly reach the time you want. Press the **▼▲** keys once at a time for fine adjustment.

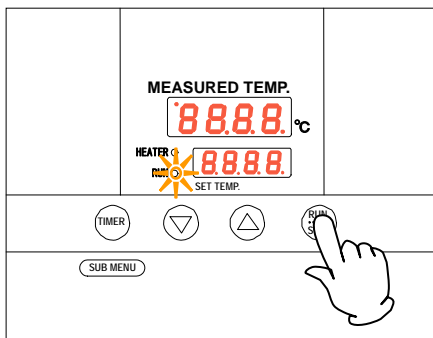

2. Starting timer operation

When the time you want is set, press the **RUN/STOP** key for about one second while characters AStr **AStr** that indicate auto start operation are displayed on the measured temperature screen and the set time on the set temperature screen.

Timer starts counting when the **RUN/STOP** key is pressed and RUN lamp blinks.

Display on the measured temperature screen switches from set time display to remaining time display.

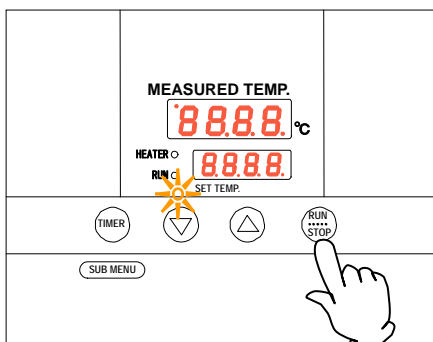

3. Stopping and ending timer operation

Operation automatically starts at the set time and the **RUN** lamp comes on.

To stop operation, press the **RUN/STOP** key for approx. one second to end the timer operation mode. The screen switches to the initial setting screen.

4. Operating procedures

Operating procedures (auto start operation)

When you want to correct set temperature or set time, or change settings

When you want to change the set temperature during timer counting, press the ▼▲ keys during that status to switch the set temperature screen to the set temperature input mode, which blinks to enable change of the set temperature with the ▼▲ keys.

When you want to change the set time during timer counting, press the **TIMER** key during that status to switch the set temperature screen to the set time input mode, which blinks to enable change of the set time with the ▼▲ keys.

In either case, the set temperature screen will stop blinking after a while and switch to the timer count mode and the change made is determined. Note, however, when you change the set time you need to set a time calculated by adding the time already passed to the time to be added.

When operation has started after the auto start time, you cannot change the set time.

When you want to stop auto start operation in the middle of it, press the **RUN/STOP** key long to stop device control once, then make settings again in the appropriate mode.

In terms of the remaining time display  a blinking dot indicates count down and an illuminating dot indicates a wait status (while temperature is increasing or decreasing to the set temperature) during which the timer has stopped counting.

4. Operating procedures

Useful functions (calibration offset function)

Using the calibration offset function

Calibration offset function compensates any differences between the target temperature in the chamber and the control temperature of the controller (sensor temperature.) The function can compensate in parallel to either plus or minus side for the whole temperature band of the unit.

The lock can be set or released with the **[SUB MENU]** keys.

The temperature is set at “0” on shipping from the factory.

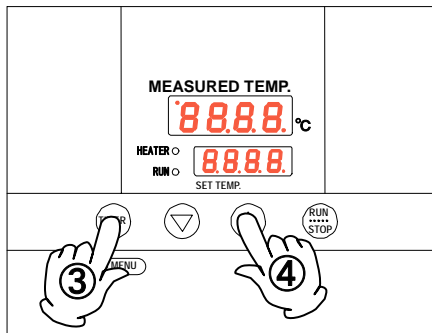
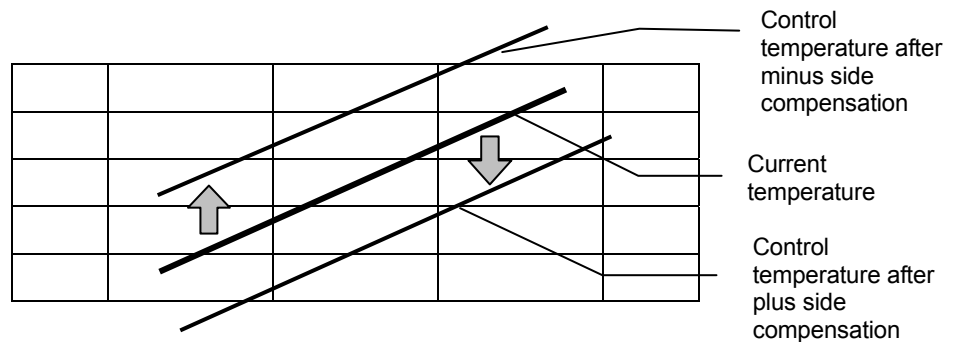

- ① Start operation at the target set temperature and confirm the temperature in the chamber with a temperature recorder after temperature has stabilized.
- ② Confirm the difference between the set temperature and that in the chamber.
- ③ Press the **[TIMER]** key (**[SUB MENU]** key) long to enter the sub menu mode.
Press the **[TIMER]** key (**[SUB MENU]** key) several times to select the characters cAL **[cAL]** that indicates the calibration offset function.
- ④ Enter the difference between the set temperature and the temperature in the chamber using the **▼▲** keys and press the **[TIMER]** key (**[SUB MENU]** key) long to exit the sub menu mode. (When you want to set the key lock function, proceed to character selection process for the key lock function without pressing the **[TIMER]** key (**[SUB MENU]** key) long.)

- * You can set either of + or – side for the offset compensation temperature. When compensation is set for the – side, the measured temperature display decreases by the compensation temperature while the temperature in the chamber increases by the same amount. When compensation is set for the + side, the measured temperature display increases by the compensation temperature while the temperature in the chamber decreases by the same amount.
- * Since too large a compensation value may result in larger difference between the actual and indicated temperatures and may present a danger, consult our nearest sales office before entering a large compensation value.
- * The device has, in addition to the calibration offset function, the two-point compensation function that adjusts offset for the lower temperature range and higher temperature range, for which adjustment temperatures have been input on shipping from the factory.
- * Consult the nearest sales office before attempting validation work for the temperature adjusting device.

4. Operating procedures

Useful function (setting lock function)

Using the lock function

This function locks the set operation status.

The temperature is set at “off” on shipping from the factory.

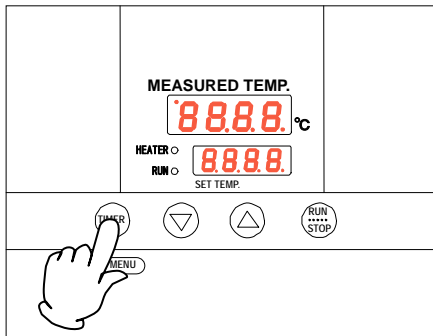

- ① Press the **TIMER** key (**SUB MENU** key) long to enter the sub menu mode.

Press the **TIMER** key (**SUB MENU** key) several times to select the characters Lock **Loch** that indicate the setting lock function.

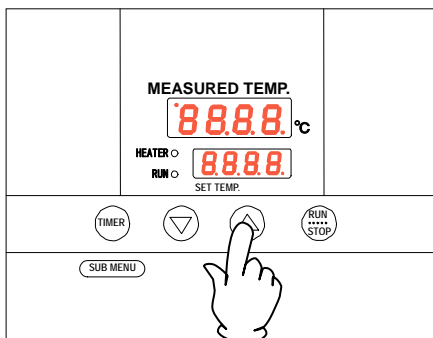

- ③ “Off” is displayed on the set temperature screen. To lock settings, change to “on” using the **▲** key.

Press the **TIMER** key (**SUB MENU** key) long to exit the sub menu mode.

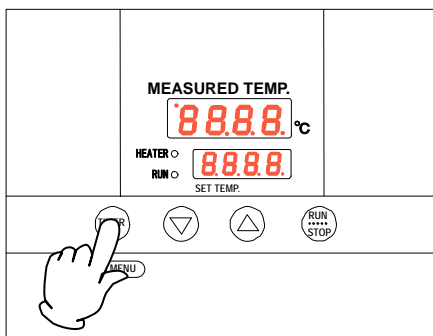

- (3) To release lock, press the **TIMER** key (**SUB MENU** key) long again and select the characters Lock **Loch** that indicate setting lock using the **▼▲** keys.

Lock is released when “off” is selected using the **▼** key.

* When the lock function is “on”, keys other than the **RUN/STOP** key and the **TIMER** key (**SUB MENU** key) are locked.

4. Operating procedures

Useful function (power outage compensation function)

Using the power outage compensation function

The power outage compensation function returns the main unit operation to the resume status after recovery from power outage, or keeps the current stop status.

The function is set at “on” on shipping from the factory.

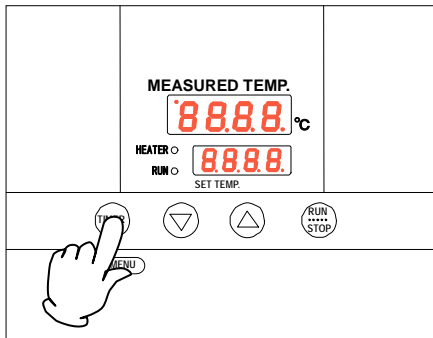

- ① Press the **TIMER** key (**SUB MENU** key) long to enter the sub menu mode.

Press the **TIMER** key (**SUB MENU** key) several times to select the characters Pon **Pon** that indicate the power outage compensation function.

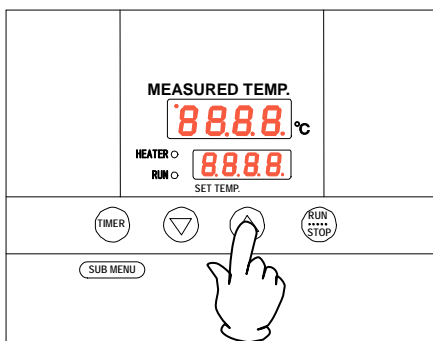

- ② “On” is displayed on the set temperature screen. The device keeps stop status after recovery from power outage when this setting is set to “off” using the ▼ key.

Press the **TIMER** key (**SUB MENU** key) long to exit the sub menu mode.

5. Cautions on handling

Warning

1. About handling of flammable or combustible solution

-  The unit is not explosion proof. Take special care for handling samples on which explosive substances, combustible substances or substances containing them. Flammable or combustible solution will evaporate when left at a room temperature (or at a lower temperature for some types of solutions) and may be ignited and explode from switches, lights and other ignitable sources. Be sure to assure sufficient ventilation when using these materials.

See section "13. List of dangerous materials" on page 36.

2. Ban on use/countermeasures when an error occurs

-  If smoke is emerges on the unit or an odd odor is felt, immediately turn the MCB on the main unit off, turn the power supply off and contact your dealer or a Yamato sales office for inspection. Otherwise, a fire or an electrical shock may result. The user shall never attempt to repair the unit to avoid any possible dangers.

Caution

1. Do not step on the unit.

-  Do not step on the unit. Otherwise, the unit may trip over or be damaged resulting a personal injury or a malfunction.

2. Do not put or drop an object on the unit.

-  2.Do not put or drop an object on the unit. Since the unit contains high precision devices, vibrations or shock may cause a malfunction.

3. When a thunder is heard.

-  When a thunder is heard, turn the MCB on the main unit off then turn the main power off immediately. Otherwise, a lightning strike may result and cause a fire.

4. During night and not to be operated for a long period of time.

-  During the night and when you want to stop the unit for a longer period of time, turn the MCB to "off" and pull out the power cord from the power supply.

5. Do not operate the unit with the door open.

- 
- When the unit is operated with the door open, the heater may overheat pausing a possible danger. Be sure to operate the unit with the door closed.
 - After operation has been completed, do not leave the unit with its door open in order to, for example, cool down samples earlier. Heat from inside the chamber may cause deformation of the control panel of a malfunction of the control devices.

5. Cautions on handling



Caution

6. Prohibition of use of corrosive samples

- ⊘ Although stainless steel is used for components in the chamber, note that they might corrode with strong acid. Door packing is made of silicon rubber. Note that silicon rubber packing may corrode with acid, alkali, oil or halogen-based solvent.

7. Always operate the unit at a correct ambient temperature.

- ⊘ Operational temperature range for the model DX302/402 is room temperature +5°C~300°C;DX602 room temperature +5°C~280°C.
Never try to operate the unit outside the operating temperature range.

8. About placement of samples

- ⊘ Withstand load of the shelf boards included is approx. 15kg. Do not place a sample heavier than this withstand load.
When putting samples, arrange them as dispersed as possible.
Too many samples may prevent proper temperature control. To assure proper temperature precision, put samples with a space at least 30% of the shelf board area.

9. Do not put a sample on the bottom inside the product.

- ⊘ Never place a sample on the bottom, since if the unit is operated with a sample directly placed on the bottom of the internal chamber, the optimal performance of the unit will not be attained, and temperature in the product may increase excessively causing a malfunction.
Arrange samples on the shelf boards supplied and set the board on the shelf clamps.

10. About recovery from power outage.

- ⚠ When the power is applied again after the unit has stopped due to power outage, the unit will automatically return to the status immediately before the power outage and resumes operation.
Turn the MCB off if you do not want to resume operation by automatic recovery.

11. About two-tier stacking

- ⊘ Stack the units in two tiers using the special stacking clamps included as optional accessories.
Do not stack the units directly on each other in two tiers.

6. Maintenance procedures

Daily inspection/maintenance

Be sure to perform daily inspection and maintenance to assure reliable operation of the unit.

Warning

- Be sure to pull out the power cord unless necessary before trying to do inspection and maintenance works.
- Start these works after the device has returned to the normal temperature.
- Never try to disassemble the unit.

Caution

- Wipe off any dirt with a tightly wrung soft cloth. Never try to clean the unit with benzene, thinner or scouring powder, or rub with a scrubbing brush. Deformation, degradation or discoloration may result.

7. When the unit is not to be used for a long time or when disposing

When the unit is not to be used for a long time or when disposing

Caution

When the unit is not going to be used for a long time

- Turn the MCB to off and pull out the power cord.

Warning

When disposing the unit

- Do not leave the unit in the area where children may have access.
- Be sure to remove handles before disposing the unit to prevent the doors from locking.
- In general, dispose the unit as a bulky waste.

Notes about disposition

Always pay attention to the preservation of the global environment.

- We highly recommend taking the unit apart as far as possible for separation or recycling to contribute to the preservation of the global environment. Major components and materials for the unit are as follows:

Names of major components	Major materials
Major mechanism part components	
Enclosure	Steel plate SPCC (powder coating)
Internal chamber	Stainless steel
Heat insulator	Rock wool
Door packing	Silicon rubber foam
Nameplates	Polyethylene (PET) resin film
Major electric parts	
Heater	Iron-chrome heater
Boards	Glass fiber and other composite parts
Power cord, wire material and others	Synthetic rubber sheathed and resin sheathed wires

8. Troubleshooting

Safety device and error codes

The unit has the self diagnostic function with a controller and a separate safety device.
Table below shows possible causes and measures when the safety device is triggered.

[Error codes]

When a functional or mechanical abnormality occurs, an error code will be displayed on the control panel. When an abnormality occurs, confirm the error code and immediately stop operation.

Safety device	Symptom	Possible causes and measures
Sensor error	Er.01 appears	<ul style="list-style-type: none">● Error in the temperature input circuit● Disconnection or other errors in the temperature sensor.● Measured temperature is outside the displayable range Contact our service department.
Memory error	Er.15 appears	<ul style="list-style-type: none">● Memory setting error Contact our service department.
Measured temperature error	---- ---- appears	<ul style="list-style-type: none">● When the upper limit alarm of the temperature alarm function is triggered. Contact our service department.

8. Troubleshooting

When a malfunction is suspected

If any of the symptoms below occurs

Symptom	Check
Turning the MCB to on will not activate the unit.	<ul style="list-style-type: none">● If the power cord is connected to the power supply securely.● If power outage is not occurring.● If the standalone overheat prevention device is working.
Temperature does not rise.	<ul style="list-style-type: none">● If the set temperature is below that in the device.● If the power supply voltage has declined.● If the ambient temperature is not low.● If cooling load for inside the chamber is not too large.
Temperature fluctuates during operation.	<ul style="list-style-type: none">● If the set temperature is appropriate.● If the power supply voltage has declined.● If ambient temperature fluctuates widely.● If cooling load for inside the chamber is not too large.
Displayed temperature differs from the measurement.	<ul style="list-style-type: none">● If the calibration offset setting is not other than "0". Set it to "0." Confirm settings in "Useful functions (calibration offset function)" in page 23.

If power outage occurs

When the power is applied again after the unit has stopped due to power outage, the unit will automatically return to the status immediately before the power outage and resumes operation. Turn the MCB off if you do not want to resume operation by automatic recovery.

- ◆ If the symptom does not match any of the above, immediately turn the MCB on the main unit off, pull out the power cord from the power supply and contact your dealer or one of our sales offices.

9. After sales service and warranty

When requesting a repair

When requesting a repair

If any trouble occurs, immediately stop operation, turn the MCB off, pull out the power plug and contact your dealer or our sales office.

Information necessary for requesting a repair

- ◆ Model name of the product
 - ◆ Serial number
 - ◆ Date (y/m/d) of purchase
 - ◆ Description of trouble (as in detail as possible)
- } Confirm on the warranty card or the nameplate installed on the unit.
See the section "3. Names and functions of parts" in page 9

Be sure to indicate the warranty card to our service representative.

Warranty card (attached separately)

- Warranty card is given by your dealer or one of our sales offices and please fill in your dealer, date of purchase and other information and store securely.
- Warranty period is one full year from the date of purchase. Repair service for free is available according to the conditions written on the warranty card.
- For repairs after the warranty period consult your dealer or one of our sales offices. Paid repair service is available on your request when the product's functionality can be maintained by repair.

Minimum holding period of repair parts

The minimum holding period of repair parts for this product is seven years after end of production.

Repair parts here refer to parts necessary for maintaining performance of the product.

10. Specifications

Model		DX302	DX402	DX602
Performance	Temperature control range	40°C~300°C		40°C~280°C
		At no load and at an ambient temperature of 23°C		
	Temperature control precision	±1°C setting: 300°C(DX302/402),280°C(DX602)		exhaust port closed
	Temperature distribution precision	±10°C (setting: 300, exhaust port closed)		±10°C (setting: 280, exhaust port closed)
	Temperature rise time	Approx. 45 minutes (Room temperature~300°C)	Approx. 60 minutes (Room temperature~300°C)	Approx. 80 minutes (Room temperature~280°C)
Mechanism	Exhaust port	Rotation damper with opening rate of 20% when closed		
	Heater	Iron-chrome heater		
		0.9 kW	1.5 kW	
Control assembly	Control system	PID control of heater output with a micro computer		
	Setting system	Digital setting using up/down keys		
	Operation mode	Fixed temperature operation, quick auto stop operation Auto stop operation, auto start operation		
	Sensor	K thermocouple		
	Auxiliary functions	Lock function, power outage compensation function, calibration offset function		
Safety device	Controller Self diagnostic function	Temperature sensor error, memory error, auto overheat prevention, measured temperature error		
	Protection device	MCB with an over current protector, Standalone overheat prevention device (Thermostat)		
Standard	Outer dimensions (mm) (w x d x h)	400 × 440 × 630	550 × 540 × 730	700 × 640 × 830
	Inner dimensions (mm) (w x d x h)	300 × 310 × 300	450 × 410 × 400	600 × 510 × 500
	Internal volume	28ℓ	74ℓ	153ℓ
	Weight	Approx. 23kg	Approx. 38kg	Approx. 56kg
	Power supply (i50/60Hz)	115V 8.5A	115V 13.5A	115V 13.5A
Included items	Shelf board x 2 (withstand load approx. 15kg /each), operating instructions, warranty card			

*Performance values are for the VAC115 power supply.

*Operating environmental temperature range for this device is 5°C~35°C.

12. List of replacement parts

Common parts

Symbol	Part name	Code No.	Specifications	Manufacturer
TH1	Temperature sensor	1-16-003-0049	LCK-M1-2000Y K single	Yamato
CONT	Planar board	LT00007640	CN40B-Y	Yamato
PIO	Display circuit board	LT00007639	CN40B-Y	Yamato
-	Tough card	LT00007641	15P 300mm	Yamato
X1	Relay	2-05-000-0019	AHE1254 @100V/120V	Matsushita
X2	Relay	LT00020609	RU2S-A110	IDEC
SSR	SSR	2-16-000-0035	TRS5255	Toho
-	Power cord	LT00008924	2.0sq 3P	Yamato
OH	Standalone overheat prevention device (Thermostat)	LT00033261	55.13265.900	E.G.O

Replacement parts for DX302

Symbol	Part name	Code No.	Specifications	Manufacturer
MCB	Circuit breaker	2060000007	BS2021 15A	Matsushita
H1 · 2	Heater	LT00020604	sus pipe heater 115V450W	Yamato

Replacement parts for DX402

Symbol	Part name	Code No.	Specifications	Manufacturer
MCB	Circuit breaker	2060000014	BS2022 20A	Matsushita
H1 · 2	Heater	LT00020605	sus pipe heater115V 750W	Yamato

Replacement parts for DX602

Symbol	Part name	Code No.	Specifications	Manufacturer
MCB	Circuit breaker	2060000014	BS2022 20A	Matsushita
H1 · 2	Heater	LT00020605	sus pipe heater115V 750W	Yamato

13. List of dangerous materials



Never use an explosive substance a flammable substance or a substance containing them for this device.

Explosive substance	Explosive substance	① Nitroglycol, glycerine trinitrate, cellulose nitrate and other explosive nitrate esters
		② Trinitrobenzen, trinitrotoluenem, picric acid and other explosive nitro compounds
		③ Acetyl hydroperoxide, methyl ethyl ketone peroxide, benzoyl peroxide and other organic peroxides
Flammable substances	Explosive substances	Metal "lithium", metal "potassium", metal "natrium", yellow phosphorus, phosphorus sulfide, red phosphorus, celluloids, calcium carbide (a.k.a, carbide), lime phosphide, magnesium powder, aluminum powder, metal powder other than magnesium and aluminum powder, sodium dithionous acid (a.k.a., hydrosulphite)
	Oxidizing substances	① Potassium chlorate, sodium chlorate, ammonium chlorate, and other chlorates
		② Potassium perchlorate, sodium perchlorate, ammonium perchlorate, and other perchlorates
		③ Potassium perchlorate, sodium perchlorate, ammonium perchlorate, and other inorganic perchlorates
		④ Potassium nitrate, sodium nitrate, ammonium nitrate, and other nitrates
		⑤ Sodium chlorite and other chlorites
		⑥ Calcium hypochlorite and other hypochlorites
	Flammable substances	① Ethyl ether, gasoline, acetaldehyde, propylene chloride, carbon disulfide, and other substances with ignition point at a degree 30 or more degrees below zero.
		② n-hexane, ethylene oxide, acetone, benzene, methyl ethyl ketone and other substances with ignition point between 30 degrees below zero and less than zero.
		③ Methanol, ethanol, xylene, pentyl acetate, (a.k.a.amyl acetate) and other substances with ignition point between zero and less than 30 degrees.
④ Kerosene, light oil, terebinth oil, isopenthyl alcohol (a.k.a. isoamyl alcohol), acetic acid and other substances with ignition point between 30 degrees and less than 65 degrees.		
Combustible gas	Hydrogen, acetylene, ethylene, methane, ethane, propane, butane and other Substance which is a flammable gas at 15 degrees, one air pressure.	

14. Standard installation manual

* Install the product according to the following: (Confirm separately for optional items or special specifications)

Model	Serial number	Date	Installation mgr. (company name)	Installation mgr.	Judgment

No.	Item	Implementation method	TOC No. Reference page of the operating instruction manual	Judgment
Specifications				
1	Included items	Check for number of staffs against the included item field	10. Specifications field P.33	
2	Installation	<ul style="list-style-type: none"> Visual check of environmental conditions Caution: Take care for environment 	2. Before operating the unit P.4 <ul style="list-style-type: none"> On the installation site 	
		<ul style="list-style-type: none"> Securing a space 		
Operation-related matters				
1	Source voltage	<ul style="list-style-type: none"> Measure the user side voltage (outlet) with a tester Measure voltage during operation (shall meet the standard) Caution: Always use a plug that meets the specification for attaching to the MCB. 	2. Before operating the unit P.8 <ul style="list-style-type: none"> Be sure to connect the ground wire. P.7 Power supply is P.33 10. Specifications <ul style="list-style-type: none"> Specification-power supply 	
2	Operation start	<ul style="list-style-type: none"> Starts operation Performs fixed value operation, auto stop operation or auto start operation	2. Before operating the unit P.4~ 8 <ul style="list-style-type: none"> Installation P.12~ 25 4. Operating procedures	
Description				
1	Operational descriptions	Explain operations of each component according to the operational instructions	4. Operating procedures P.12~ 25 <ul style="list-style-type: none"> Operating procedures P.1~ ~36 1. Safety precautions ~ 13. List of dangerous materials	
2	Error codes	Explain the customer about error codes and procedures for release according to the operational instructions	8. Troubleshooting P.30 ~ 9. After sales service and warranty 32	
3	Maintenance and inspection	Explain operations of each component according to the operational instructions	6. Maintenance procedures P.28 <ul style="list-style-type: none"> Daily inspection/ maintenance 	
4	Completion of installation Entries	<ul style="list-style-type: none"> Fill in the installation date and the installation mgr. on the nameplate of the main unit Fill in necessary information to the warranty card and hand it over to the customer Explanation of the route for after-sales service 	9. After sales service and warranty P.32	

Limited liability

Be sure to use the unit strictly following the handling and operating instructions in this operating instruction.

Yamato Scientific Co., Ltd. assumes no responsibility for an accident or a malfunction caused by use of this product in any way not specified in this operating instruction.

Never attempt to perform matters prohibited in this operation instruction.

Otherwise, an unexpected accident may result.

Notice

- **Descriptions in this operating instruction are subject to change without notice.**
- **We will replace a manual with a missing page or paging disorder.**

Operating instruction
Constant Temperature Drying Oven
DX302/402/602
Third edition Jan. 20, 2011

Yamato Scientific America, Inc.
925 Walsh Ave, Santa Clara, CA 95050
Tel:408-235-7725
For technical information
and service, call: 1-800-292-6286
<http://www.yamato-usa.com>