

SINCE 1889



Constant Temperature Drying Oven

Model

DVS402C/DVS602C

DVS412C/DVS612C

- Second Edition -

- Thank you very much for purchasing this Yamato DVS series constant temperature drying oven.
- Please read the “Operating Instructions” and “Warranty” before operating this unit to assure proper operation. After reading these documents, be sure to store them securely together for future reference.
- **⚠ WARNING!**
Carefully read and thoroughly understand the important warning items described in this manual before using this unit.

Yamato Scientific America Inc.

Table of contents

1. Safety precautions	1
Explanation of symbols.....	1
List of symbols.....	2
Warning • Cautions	3
2. Before operating the unit	4
Precautions when installing the unit	4
3. Names and functions of parts	9
Main body.....	9
Operation panel.....	10
Explanation of characters	11
4. Operating procedures	13
List of operation modes and functions.....	13
Operation mode • function setting keys and characters	15
Settings for overheat prevention device	16
Operating procedures (fixed temperature operation).....	17
Operating procedures (quick auto stop operation)	18
Operating procedures (auto stop operation).....	19
Operating procedures (auto start operation).....	21
Preparing a program.....	23
Program repeat operation.....	28
Programming sheet	29
Useful functions (calibration offset function)	31
Useful function (lock function)	32
5. Cautions on handling	33
6. Maintenance procedures	35
Daily inspection/maintenance.....	35
7. When the unit is not used for a long time or when disposing	36
When the unit is not used for a long time or when disposing.....	36
Notes about disposition	36
8. Troubleshooting	37
Safety device and error codes.....	37
When a malfunction is suspected	38
9. After sales service and warranty	39
When requesting a repair	39
10. Specifications	40
11. Wiring diagram	41
12. List of replacement parts	42
13. List of dangerous materials	43
14. Standard installation manual	44



1. Safety precautions

Explanation of Symbols

About Symbols

A variety of symbols are indicated in this operating instruction and on products to assure safe operation. Possible results from improper operation ignoring them are classified as follows.

Be sure to fully understand the descriptions below before proceeding to the text.



	Warning	Indicates a situation which may result in death or serious injury (Note 1)
	Caution	Indicates a situation which may result in minor injury (Note 2) and property damage (Note 3).

(Note 1) Serious injury means a wound, an electrical shock, a bone fracture or intoxication that may leave after effects or require hospitalization or outpatient visits for a long time.

(Note 2) Minor injury means a wound or an electrical shock that does not require hospitalization or outpatient visits for a long time.

(Note 3) Property damage means damage to facilities, devices and buildings or other properties.

Meanings of pictograms

-  This symbol indicates a matter that encourages the user to adhere to warning ("caution" included).
Specific descriptions of warnings are indicated near this symbol.
-  This symbol indicates prohibitions
Specific prohibitions are indicated near this symbol.
-  This symbol indicates matters that the user must perform.
Specific instructions are indicated near this symbol.

1. Safety precautions

List of symbols

Warning



General warnings

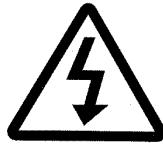

Danger!
High voltage



Danger!
High temperature



Danger!
Moving part



Danger!
Hazard of explosion

Caution



General cautions



Electrical shock!



Burning!



Caution for no
liquid heating!



Caution for water
leak!



For water only



Poisonous
material

Prohibitions



General bans



Fire ban



Do not
disassemble



Do not touch

Compulsions



General
compulsions



Connect ground
wire



Install levelly



Pull out the power
plug



Regular
inspection

1. Safety precautions

Warning · Cautions

Warning



Never operate the unit in an atmosphere containing flammable or explosive gas

Never operate the unit in an atmosphere containing flammable or explosive gas. Otherwise, an explosion or a fire may result since the unit is not explosion-proof. See section "13. List of dangerous materials" on page 43.



Be sure to connect the ground wire.

Be sure to connect the ground wire correctly. Otherwise, electrical leak may result and cause an electrical shock or a fire.



Ban on operation when an abnormality occurs

When a smoke or an unusual odor is seen or sensed, immediately turn the power switch on the main unit off and pull out the power cord (plug) from the power supply. A fire or an electrical shock may result.



Never use electrical power cords bundled.

When these are used bundled, they might overheat causing a fire.



Take care not to damage electrical power cords.

Avoid tightly bend; pull with a strong force or twist to prevent electrical power cords from damaging. A fire or an electrical shock may result.



Never use an explosive or a flammable material with this unit.

Never use an explosive material, a flammable material or a material containing them. An explosion or an electrical shock may result. See section "13. List of dangerous materials" on page 43.



Never try to touch a hot part.

Some parts of the unit are hot during and immediately after operation. Take special care for possible burning.



Never try to disassemble or alter the unit.

Never try to disassemble or alter the unit. A malfunction, a fire or an electrical shock may result.



Caution



When a thunder is heard.

When a thunder is heard, turn the main power off immediately. A malfunction, fire or an electrical shock may result.

2. Before operating the unit

Precautions when installing the unit



Warning

1. Be sure to connect the ground wire.



- The DS402C/602C types use a single-phase 115V, DVS412C/612C types use a single-phase 220V power source. Please consult your local electrical contractor for power connecting work.
- Be sure to connect the ground wire (green core wire of the power cord) to the ground wire or the ground terminal in order to prevent an electrical shock from electric leakage.
- Never connect the ground wire to gas or water pipes. Otherwise, a fire may result.
- Never connect the ground wire to the ground for telephone wire or lightning conductor. Otherwise, a fire or an electrical shock may result.
- Do not use a branching receptacle, which may generate heat and possible danger.

We recommend use of a ground type outlet When a bipolar type outlet tap is used
tap.

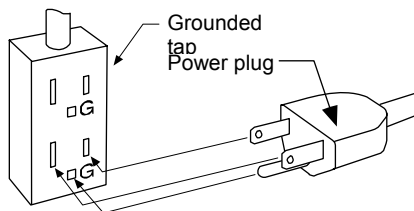

When there is no ground terminal.

- In this case, class 3 grounding work is necessary and please consult your dealer or our nearest sales office.

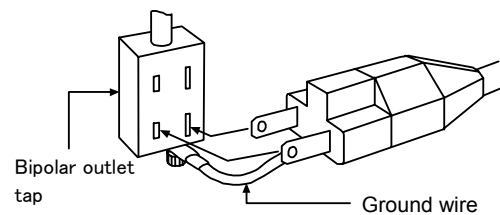

- Insert the ground adaptor included as an option, into a power plug confirming the polarity of the outlet. Connect the grounding wire (green) of the ground adaptor to the ground terminal on the power supply equipment.

2. Carefully select an installation site.



Take special care not to install the unit at a place described below:

- On uneven or dirty floor
- Where combustible gas or corrosive gas exists
- Where the ambient temperature is 35°C or more
- Where temperature widely fluctuates
- Where there is excessive dust or humidity
- Where subject to direct sunlight
- Where vibration is severe



Install this unit at a place with spaces shown below.
Do not cover the exhaust ports on the top of the unit.

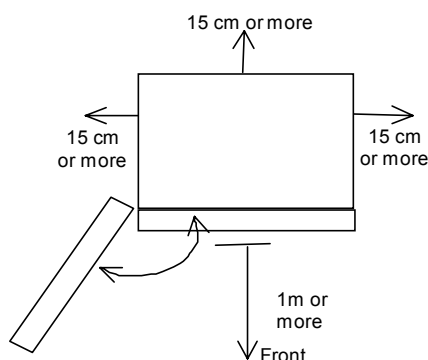

2. Before operating the unit

Precautions when installing the unit

Warning

3. Never operate the unit in an atmosphere containing explosive or flammable gas



Never operate the unit in an atmosphere containing flammable or explosive gas. Since the unit is not explosion-proof, an arc is discharged when turning a switch "ON" and "OFF" and during operation and a fire or an explosion may result.



See the section "13. List of dangerous materials" on page 43 for flammable and explosive gases.

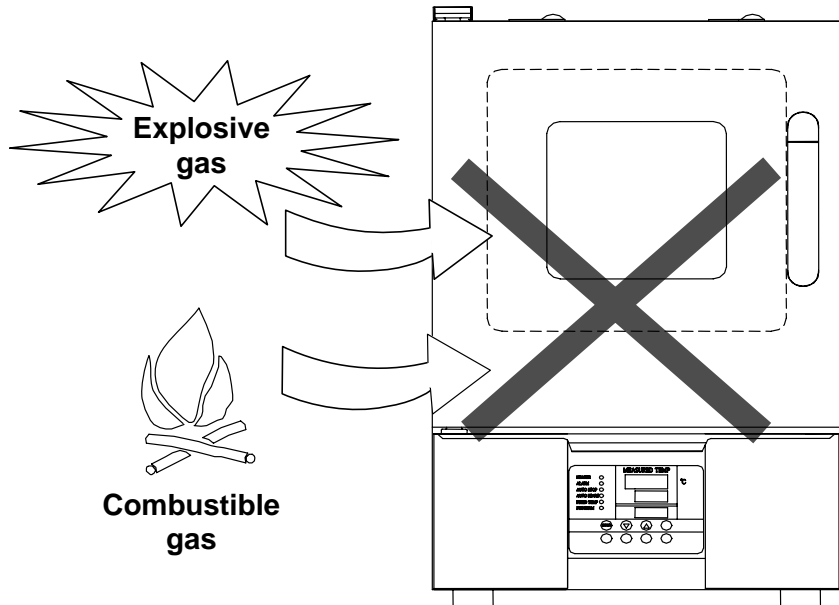

Never use the unit with an explosive material, a flammable material or a material containing them. An explosion or a fire may result.

See the section "13. List of dangerous materials" on page 43 for flammable and explosive substances.

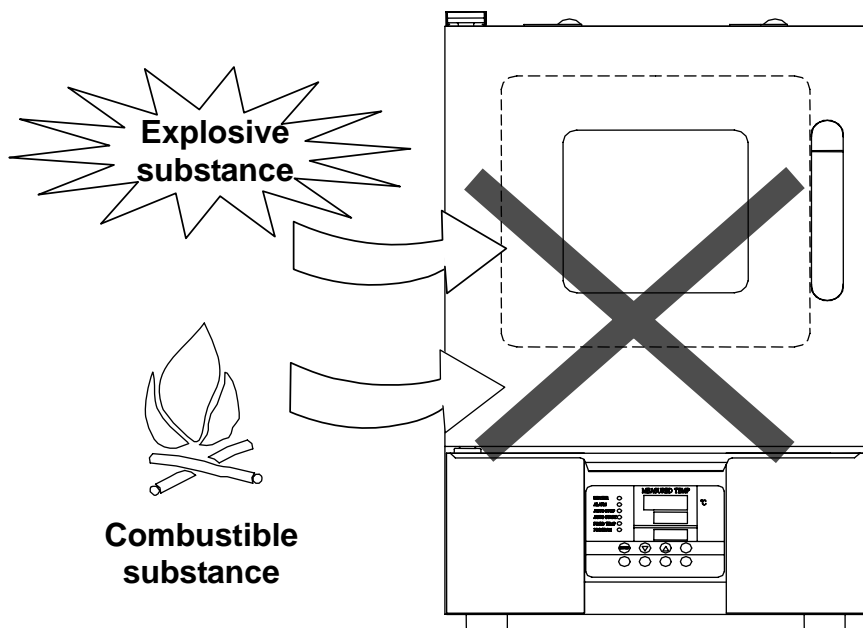

2. Before operating the unit

Precautions when installing the unit



Warning

4. Do not alter the product.

-  The user shall never attempt to alter the unit since it may cause a malfunction.

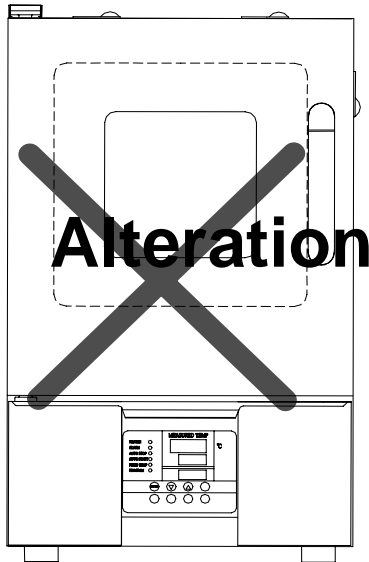

5. Install the unit on a level surface

-  Install the unit on a level surface. Installing this unit on a slope might cause unexpected troubles or malfunctions.

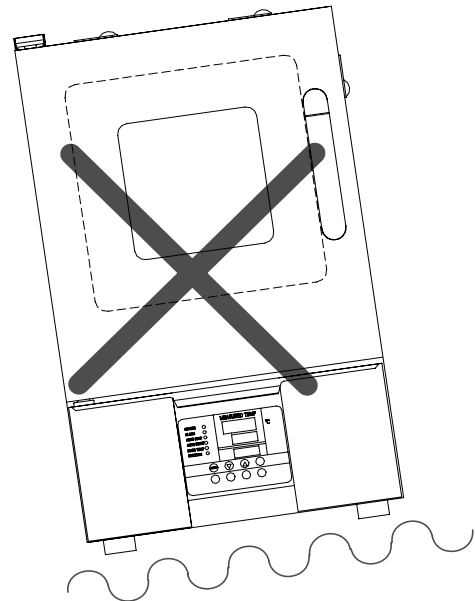

6. Do not overload shelves.

-  Withstand load of each shelf board is 15kg in uniform loading. Place samples in a dispersed fashion.

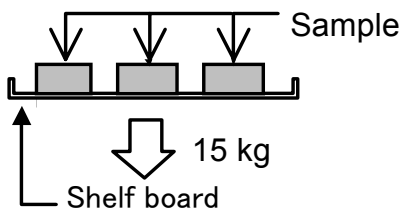

7. Do not place too many samples.

-  Too many samples may prevent proper temperature control. Be sure to use shelf boards and place samples apart each other so as to make free space of 30% or more to assure proper temperature accuracy.

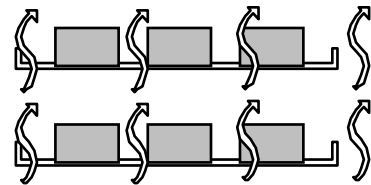

Make at least 30% of space

2. Before operating the unit

Precautions when installing the unit

Caution

8. Be sure to connect the power plug to the dedicated wall outlet.



Use a power distribution panel or a wall outlet that meets the electrical capacity of the unit.

Electric capacity:	DVS402C	AC115V	11.5A	DVS412C	AC220V	6.75A
	DVS602C	AC115V	13.1A	DVS612C	AC220V	7.25A

When the unit will not start even when you turn the power switch to "ON", check for low main voltage or if the unit is connected to the same power supply line as other devices and connect it to another line if necessary.

9. Installation



The unit might fall down or move by an earthquake or an impact resulting to a personal injury.

We recommend making safety measures such as to avoid installing the unit at a place other than busy places.

Also, take appropriate safety measures to prevent the unit from tripping over.

10. Placing shelf boards and samples



Two shelf boards are included with this product.

One of them has been fixed on the lowest stage of the shelf pillar of the internal bath at the time of shipping from the factory.

Set another board to an appropriate position in the bath.

A heater is installed under the flow adjusting board. Thus, the temperature of the flow adjusting board and around it is always higher than the set temperature and placing a sample directly on the board may damage it or cause a fire.

Therefore, the shelf board is fixed with screws as shown to disable direct placement of samples.

Because of the shape of samples, when the unit is operated with shelf boards removed to accept them, assure sufficient space between them and the flow adjusting board and never place samples directly on the flow adjusting board.

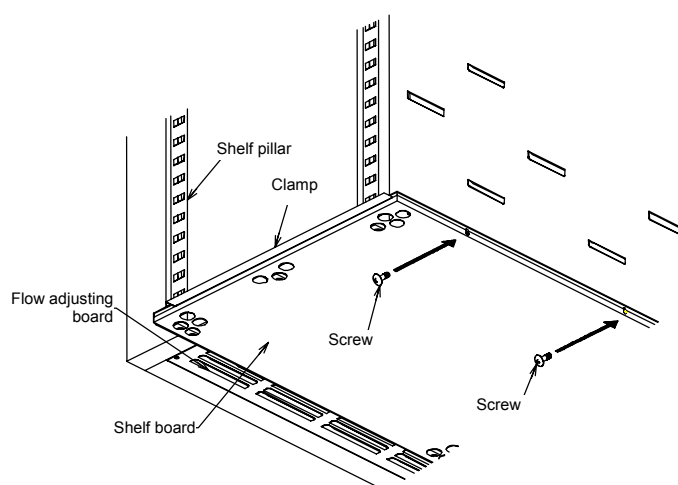



2. Before operating the unit

Precautions when installing the unit



11. About handling of the power cord

-  Never use electrical power cords bundled. When these are used bundled, they might overheat causing a fire.
Do not convert, forcibly bend, twist or pull the power cord. Otherwise, a fire or an electrical shock may result.
Do not place the power cord under a desk or a chair, or sand between objects to avoid it from being damaged.
-  Do not place the power cord close to a stove or other heat generating device. Sheath of the cord may burn and result in a fire or an electrical shock.
If the power cord should be damaged (exposure of core wire or disconnection), immediately turn the main unit off, pull out the power cord (plug) out of the power supply and ask your dealer to replace the cord. Otherwise, a fire or an electrical shock may result.
Connect the power cord to an appropriate wall outlet.

12. When you operate the unit for the first time

-  When you operate the unit for the first time at a higher temperature, the unit may generate an odor. This is due to decomposed bonding material contained in heat-insulation material and is not a malfunction of the unit. We recommend operating the unit at the highest temperature once before starting its regular operation.

3. Names and functions of parts

Main body

Front view

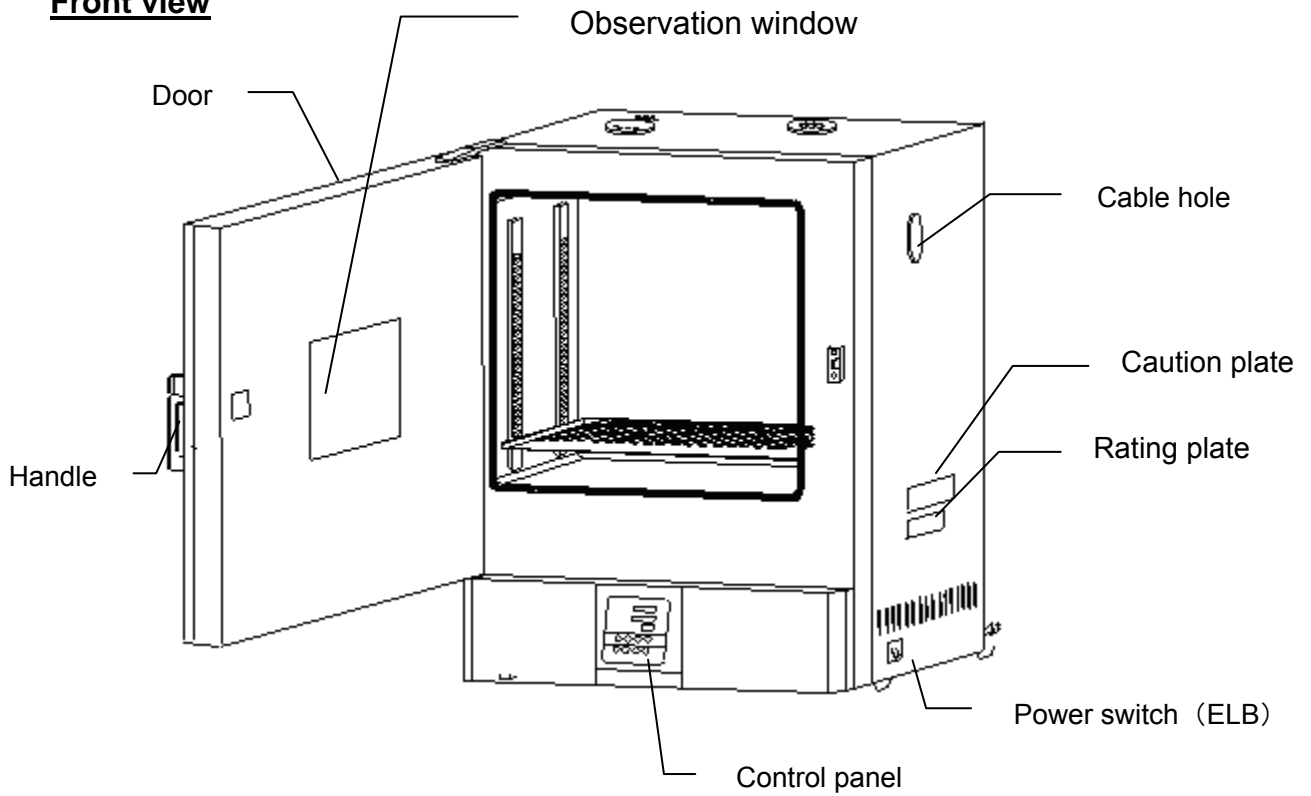

Rear View

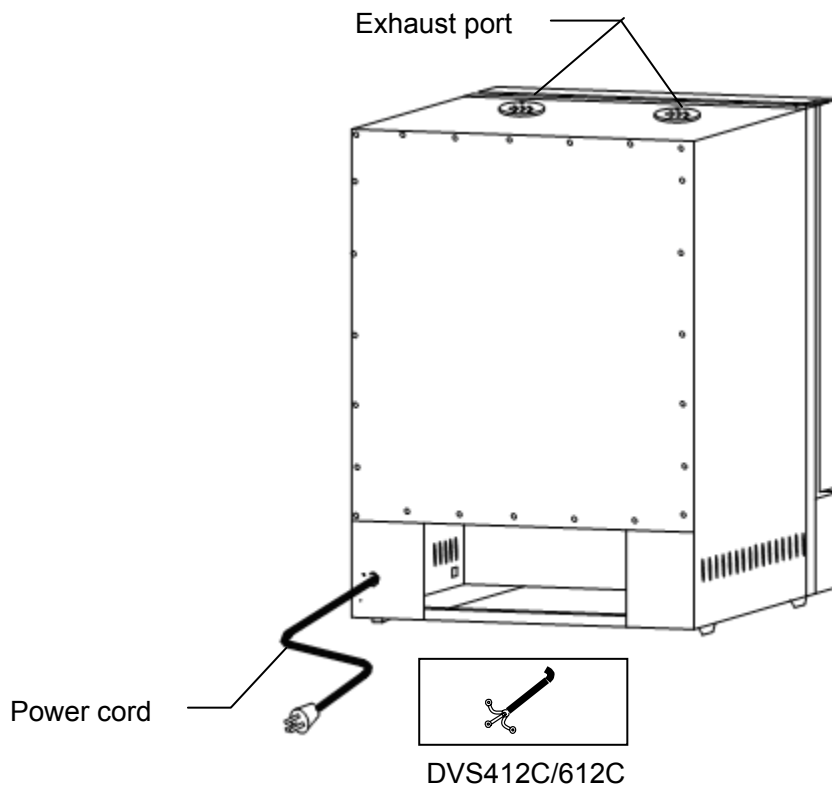

3. Names and functions of parts

Operation panel

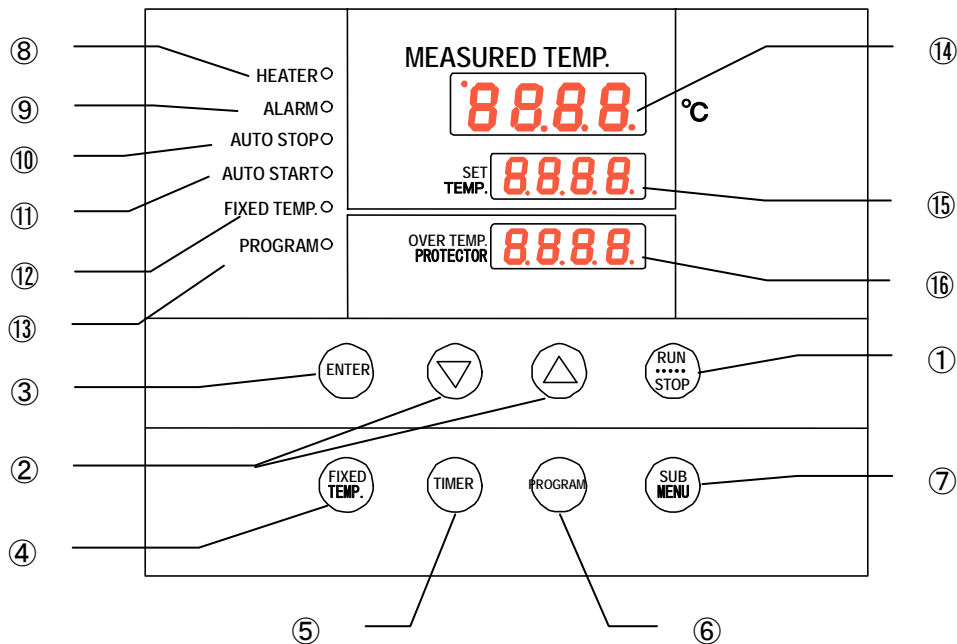











No.	Name	Operation/action
①	RUN/STOP key	Used for starting/stopping operation
②	▲▼ keys	Used for selecting settings.
③	ENTER key	Used for determining a selected setting.
④	FIXED TEMP. key	Key for selecting fixed temperature operation.
⑤	TIMER key	Key for selecting timer operation. Quick auto stop operation, auto stop operation or auto start operation can be selected.
⑥	PROGRAM key	Used for selecting programming and starting the program operation. Programs of six patterns in three types can be set.
⑦	SUB MENU key	Key for setting temperature of the overheat prevention device, calibration offset temperature, the key lock function or the program repeat function.
⑧	HEATER lamp	Illuminates while heater power is on.
⑨	ALARM lamp	When an error occurs, the lamp illuminates with an audible buzzer.
⑩	AUTO STOP lamp	Flashes while the quick auto stop timer is being set and illuminates while the unit is in operation. Flashes while the auto stop timer is being set and illuminates while the unit is in operation.
⑪	AUTO START lamp	Flashes while the auto start timer is being set and illuminates while the unit is in operation.
⑫	FIXED TEMP. lamp	Flashes while fixed temperature operation is being set and illuminates while the unit is in operation.
⑬	PROGRAM lamp	Flashes while the program operation is being set and illuminates while the unit is in operation.
⑭	MEASURED TEMP. display	Displays measured temperature in the bath · set characters · alarm information.
⑮	SET TEMP. display	Displays a set temperature, timer settings and timer remaining time.
⑯	OVER TEMP. PROTECTOR display	Displays the set temperature for the overheat prevention device.

3. Names and functions of parts

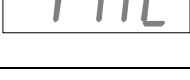

Explanation of characters

Characters on the VS4 type controller are explained in this section.

Characters	Identifier	Name	Application
	Fix	Fixed temperature operation setting	Means settings for fixed temperature operation.
	Sv	Temperature setting	Used for setting a temperature.
	AS _T P	Auto stop setting	Used for setting auto stop operation.
	AS _t r	Auto start setting	Used for setting auto start operation.
	tim	Time setting	Used for setting a time.
	PrG3	Program type select	Used for selecting a program type 1, 2 or 3 to be used. See section "Preparing a program on page 23."
	PA _t	Program pattern select	Used for selecting a program pattern to be used. See section "Preparing a program on page 23."
	End	Time up	Displayed when timer operation has ended. See page 18, 19, and 21.
	Sv-1	Program temperature setting	Used for setting temperatures for each step of a program. (Sv-1 to Sv-30 is displayed.)
	t-1	Program time setting	Used for setting time for each step of a program. (t-1 to t-30 is displayed.)
	PS-3	Program repeat Selecting a return destination	Used for selecting a step for returning during program repeat operation. See section "Program repeat operation" on page 28.
	Pc-2	Setting number of program repetitions	Used for setting number of program repeat operations. See section "Program repeat operation" on page 28.

3. Names and functions of parts

Explanation of characters

Characters	Identifier	Name	Application
	cAL	Calibration offset setting	Used for inputting a calibration offset temperature See section "Using the calibration offset function" on page 31.
	oH	Setting overheat protection device temperature	Used for setting an overheat protection device temperature. See section "Settings for overheat prevention device" on page 16.
	Lock	Key lock of settings	Key locks settings to prevent their alteration See section "Using" on page 32.

* See the section "Operation mode • function setting keys and characters" on page 15 for characters of operation modes and functions

4. Operating procedures

List of operation modes and functions

Operation modes of the unit are as shown below:

No.	Name	Description	Page
1	Fixed temperature operation	Pressing the FIXED TEMP. key to enter the fixed temperature operation setting mode. Pressing the FIXED TEMP. key again to enter the temperature setting mode. Set a temperature with the ▼▲ keys. Pressing the RUN/STOP key to start operation, and pressing the RUN/STOP key again to stop operation.	P.17
2	Quick auto stop operation	Used when you want to, for example, “stop operation being performed automatically in several hours.” Pressing the TIMER key during the fixed temperature operation to enable setting a time before operation stops. Set duration before stop with the ▼▲ keys. Pressing the RUN/STOP key starts quick auto stop operation and activates the timer in the middle of it to automatically stop it after the set period of time.	P.18
3	Auto stop operation	Used when you want to “set automatic stop for fixed temperature operation when making settings for it.” Press the TIMER key to display “AStP.” Pressing the ENTER key to set the temperature setting “Sv.” Pressing the ENTER key again to enable setting of the operation time “tim.” Pressing the RUN/STOP key starts auto stop operation.	P.19
4	Auto start operation	Used when you want to “start operation automatically after several hours” after power is turned on. Press the TIMER key to display “AStr.” Pressing the ENTER key to set the temperature setting “Sv.” Pressing the ENTER key again to enable setting of the operation time “tim.” Pressing the RUN/STOP key starts auto start operation.	P.21
5	Program operation	This is used to raise or lower temperature based on the set temperature and time. Press the PROGRAM key to display “PrGn.” (n:1,2,3) Press the PROGRAM key again to select a program mode you want. To select “PrG2” or “PrG3”, press the ENTER key to select a pattern “PAT” you want. Pressing the RUN/STOP key starts program operation.	P.23
* Operation mode cannot be changed while the unit is in operation. First stop operation before changing the mode.			

4. Operating procedures

List of operation modes and functions

Operating functions of the unit are as shown below:

No.	Name	Description	Page
1	Overheat prevention function	<p>Automatic overheat prevention function: This function is linked to the unit set temperature and has been set to so that it is automatically activated (returned automatically) at a temperature 12°C higher than the set temperature in the bath.</p> <p>Overheat prevention device: Although the power supply, the display and the key input assembly are in common with the controller, the device consists of the standalone temperature measurement circuit, the CPU, the sensor, and the output circuit enabling to set to a temperature you want on the operation panel. If the overheat prevention device is triggered, the unit will stop and will not recover until the power switch is turned on again. (Manual recovery)</p>	P.16
2	Calibration offset function	<p>Calibration offset function compensates any differences between the target temperature in the bath and the control temperature of the controller (sensor temperature.) The function can compensate to either plus or minus side for the whole temperature band of the unit.</p>	P.31
3	Overheat prevention temperature compensation function	When temperature compensation in item two is made for the controller, temperature to be input to the overheat prevention device will also be compensated automatically.	—
4	Power outage compensation function	When power outage occurs in the middle of operation, the operation resumes from the status immediately before the power outage.	—
5	Setting lock function	<p>This function locks the set operation status. The lock can be set or released with the SUB MENU key.</p>	P.32

4. Operating procedures

Operation mode • function setting keys and characters

Key operations and characters in the diagram below are used for operation mode and function settings.

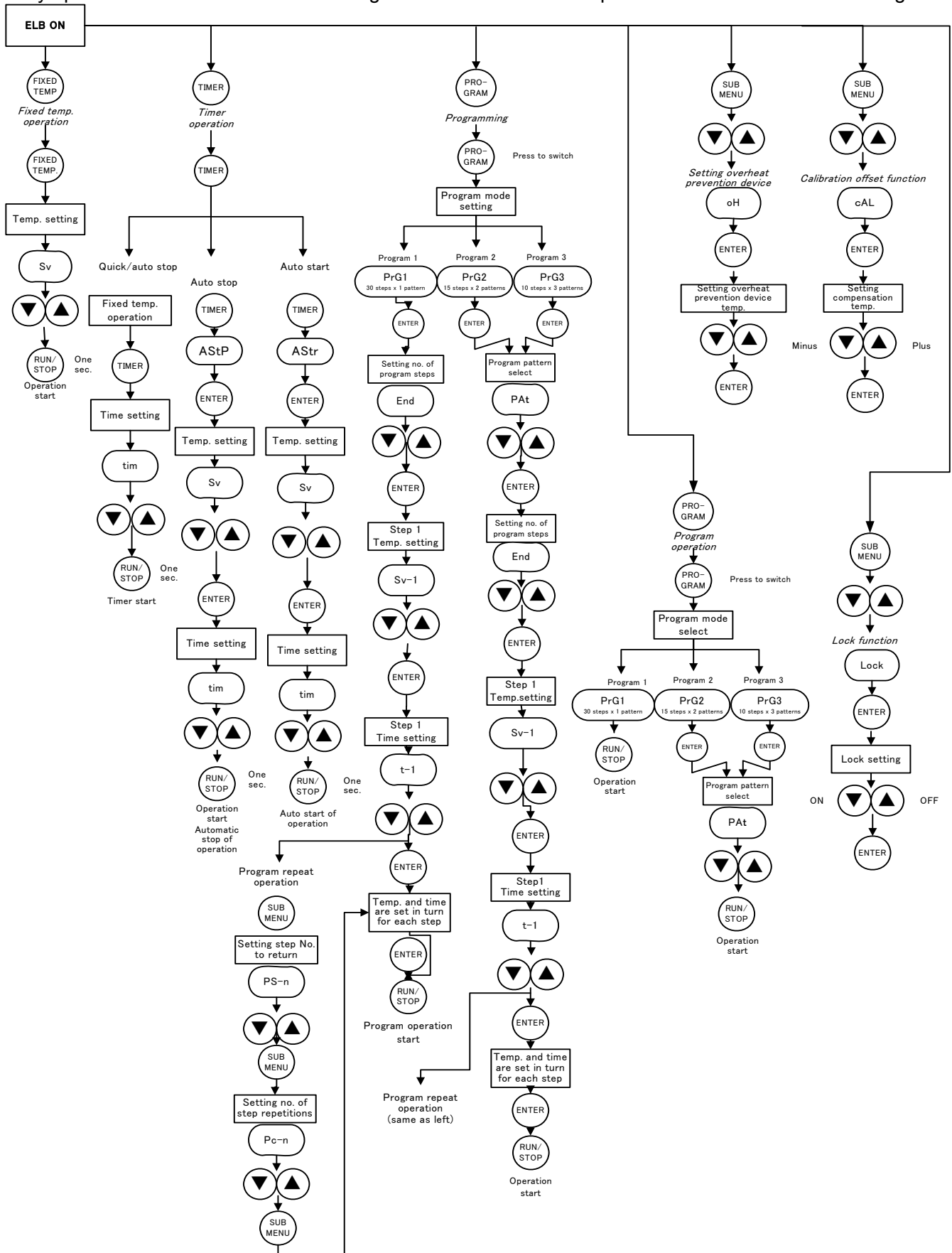

4. Operating procedures

Settings for overheat prevention device

The safety device for preventing overheat has the automatic overheat prevention function for the controller (automatic recovery) and has the power supply, the display and the key input assembly in common with the controller as well as it has an overheat prevention device (manual recovery) as a secondary safety measures that consists of separate temperature measurement circuit, the CPU, the sensor and the output circuit.

Temperature setting range and functions

The device has overheat prevention function in double. One is the function integrated in the controller, which is designed to be activated automatically at a temperature 12°C above the set temperature of the temperature controller (the heater repeats ON/OFF at +12°C) at the time of shipping from the factory.

Another is integrated with the controller and is set with the keys on the controller.

The secondary overheat prevention function is added by this setting.

The temperature range settable for the overheat prevention device integrated with the controller is “0°C to the 50°C + the highest set temperature for the device.”

When the temperature in the bath keeps rising beyond the controller set temperature and reaches the set temperature of the overheat prevention device, the circuit trips, Er19 flashes on the controller screen, and the buzzer continues to sounds.

When the overheat prevention device is activated, it will not be released until power is turned on and Er19 will not be released.

How to set temperature

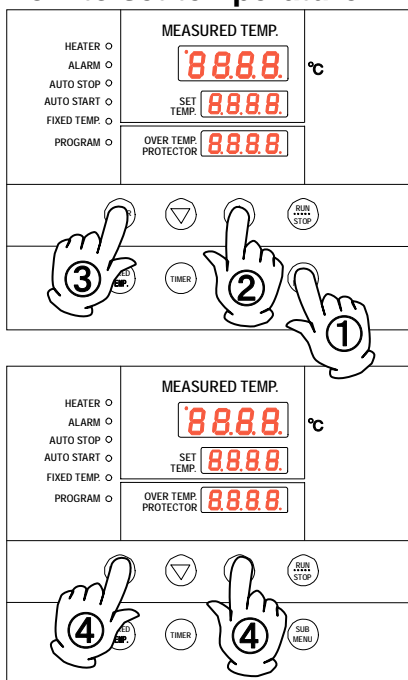

1. Turn power ON. (Turn the ELB to ON.)

When power is turned ON, the initial values will be displayed for about four seconds, then the initial screen will appear and the current bath temperature, operation mode character and the overheat prevention set temperature are displayed on each of the displays.

2. Setting the overheat prevention temperature

- 1 Press the **SUB MENU** key.
- 2 Press the **▼▲** keys to select the overheat prevention temperature setting character oH for the MEASURED TEMP. display.
- 3 Pressing the **ENTER** key displays the current set temperature flashing on the SET TEMP. display.
Caution: In general, set to a temperature at least 10°C higher than the controller set temperature to prevent the device from malfunctioning.
- 4 When the temperature you want is obtained with the **▼▲** keys, press the **ENTER** key to complete setting.

Caution

- 1 Set temperature as “highest operation temperature for the unit +20°C” or “set temperature +20°C” as a rough standard and add 5°C to the setting if the device functions improperly.
- 2 Be sure to set the overheat prevention activation temperature correctly otherwise the device may not start, the overheat prevention device is activated before temperature in the bath increases completely, or a fire or other unexpected accidents may result.
The temperature is set at 290°C on shipping from the factory.
- 3 The overheat prevention device has been designed to prevent overheating of devices not to protect samples. The device does not prevent accidents caused from use of explosive or flammable materials.

4. Operating procedures

Operating procedures (fixed temperature operation)

How to start fixed temperature operation

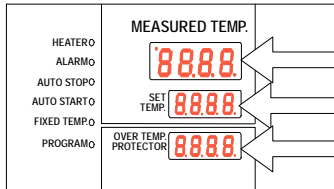

1. Turn power ON. (Turn the ELB to ON.)

When power is turned ON, the initial values will be displayed for about four seconds, then the initial screen will appear and the current bath temperature, operation mode character and the overheat prevention set temperature are displayed on each of the displays.

MEASURED TEMP. display: Indicates the present bath temperature and various characters.

Set temperature display: Indicates the set temperature and various characters.

Overheat prevention set temperature display: Indicates the set temperature for the overheat prevention device.

For operation mode characters, see section page 11.

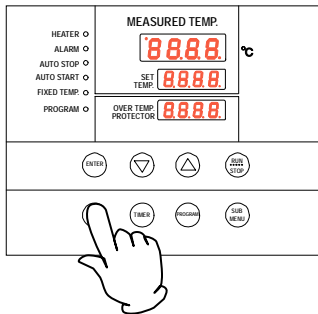

2. Selecting an operation mode

Press the **FIXED TEMP.** key to display the fixed temperature operation mode on the SET TEMP. display.

Display the character Fix **Fi II**.

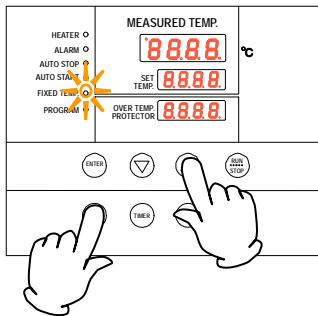

3. Setting the temperature

Press the **FIXED TEMP.** key again.

The character SV **50** that indicate a set temperature is displayed on the MEASURED TEMP. display on which the current set temperature flashes and the FIXED TEMP. lamp flashes.

Set a temperature using the ▼▲ keys.

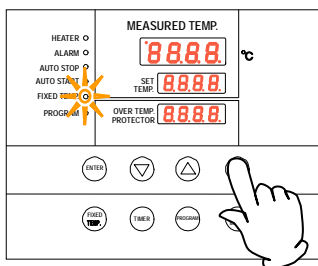

4. Starting operation

Press the **RUN/STOP** key for about one second. Operation starts and status of the FIXED TEMP. lamp changes from flashing to illuminated.

5. Stopping operation

Press the **RUN/STOP** key for about one second. Operation stops, the FIXED TEMP. lamp goes off and the screen switches to the initial setting screen.

When you want to correct setting errors or confirm settings

When you made a mistake during setting or reconfirm settings you made, press the **FIXED TEMP.** key again to resume setting.

When you want to change set temperature during operation, press the **FIXED TEMP.** key to enter the setting mode and change the set temperature. After change has been made, press the **ENTER** key to complete the process.

4. Operating procedures

Operating procedures (quick auto stop operation)

Procedures for quick auto stop operation

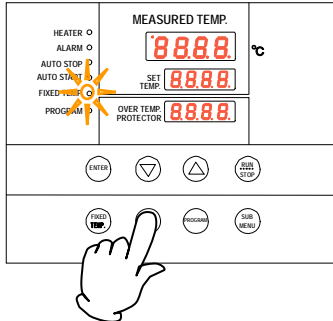

Used when you want to, for example, “stop fixed temperature operation being performed automatically in several hours. Quick auto stop operation is a function to enable auto stop timer setting during operation.

1. Setting time period before stop during fixed temperature operation

Make sure that the FIXED TEMP. lamp is illuminated to indicate the unit is the fixed temperature operation mode.

Press the **TIMER** key.

The character tim **ti n** that indicates the timer is displayed on the MEASURED TEMP. display and the current set time flashes on the SET TEMP. display.

Set a time you want using the **▼▲** keys.

About the timer function

The maximum time that can be set for the timer is 999 hours 50 minutes.

Up to 99 hours 59 minutes, time can be set in minutes.

One hundred hours and over are set only in 10 minutes.

Keep the **▼▲** keys pressed to continuously change set time and you can quickly reach the time you want. Press the **▼▲** keys once at a time for fine adjustment.

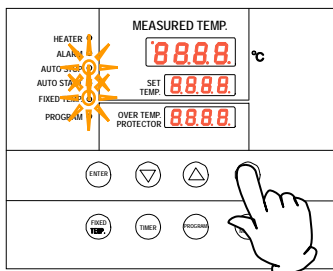

2. Starting timer operation

When you have set a time you want, start the **RUN/STOP** key for about one second. Timer operation starts with the FIXED TEMP. lamp and the AUTO STOP lamp are illuminated. Timer starts counting when the **RUN/STOP** key is pressed.

3. Stopping and ending timer operation

Operation stops automatically when the set time comes.

The buzzer sounds for about five seconds to indicate operation has stopped. At this time, the character End **End** that indicates operation end is displayed on the SET TEMP. display with the FIXED TEMP. lamp and the AUTO STOP lamp are illuminated.

Press the **RUN/STOP** key for approx. one second to end the timer operation mode. The screen switches to the initial setting screen.

When you want to correct temperature or set time, or confirm settings

When you want to change set temperature during operation, press the **FIXED TEMP.** key to enter the setting mode and change the set temperature. After change has been made, press the ENTER key to complete the process. When you want to change set time during operation, press the **TIMER** key to enter the setting mode and change the set time. Note, however, you need to set a time calculated by adding the time already passed to the time to be added. After change has been made, press the **RUN/STOP** key to complete the process.

Pressing the **▼** key will display the set temperature, the operation mode and the remaining time on the SET TEMP. display.

4. Operating procedures

Operating procedures (auto stop operation)

Procedures for auto stop operation

Used when you want to “set automatic stop after set time has elapsed from the start of the fixed temperature operation.”

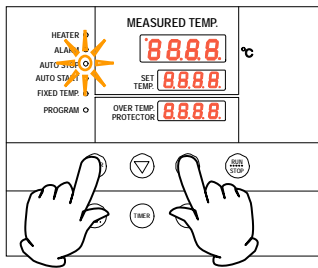
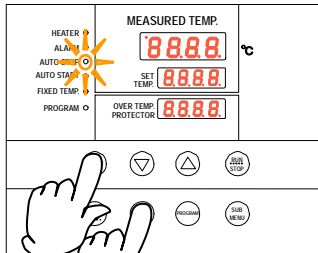

1. Setting a stop time

- ① Press the **TIMER** key in the initial screen.
- ② The timer mode you used in the previous session is displayed on the SET TEMP. display.

Pressing the **TIMER** key again to flash the timer mode. Pressing the **TIMER** key again to flash the next timer mode.

Select the character **ASTP** that indicates the auto stop operation and press the **ENTER** key.

The character **Sv 50** that indicate a set temperature is displayed on the MEASURED TEMP. display on which the current set temperature flashes and the AUTO STOP lamp flashes.

- ③ Set a temperature you want using the **▼▲** keys.
- ④ Press the **ENTER** key. The character **tim 610** that indicates the timer is displayed on the MEASURED TEMP. display and the current set time flashes on the SET TEMP. display.
- ⑤ Set a time you want using the **▼▲** keys.

About the timer function

The maximum time that can be set for the timer is 999 hours 50 minutes.

Up to 99 hours 59 minutes, time can be set in minutes.

One hundred hours and over are set only in 10 minutes.

Keep the **▼▲** keys pressed to continuously change set time and you can quickly reach the time you want. Press the **▼▲** keys once at a time for fine adjustment.

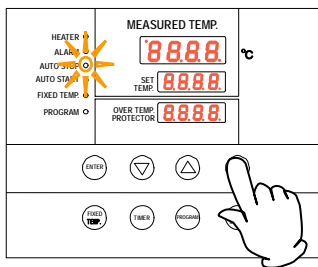

2. Starting timer operation

When you have set a time you want, start the **RUN/STOP** key for about one second.

Timer operation starts with the AUTO STOP lamp is illuminated.

Timer starts counting when the temperature in the bath (measured temperature) reaches the set temperature.

4. Operating procedures

Operating procedures (auto stop operation)

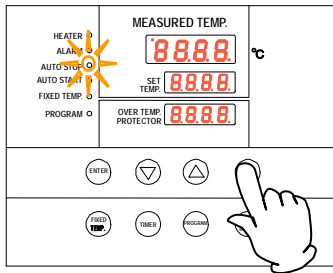

3. Stopping and ending timer operation

Operation stops automatically when the set time comes.

The buzzer sounds for about five seconds to indicate operation has stopped. At this time, the character End End that indicates operation end is displayed on the SET TEMP. display with the AUTO STOP lamp is illuminated. Press the RUN/STOP key for approx. one second to end the timer operation mode. The screen switches to the initial setting screen.

When you want to correct set temperature or set time, or confirm settings

When you want change the set temperature or a set time, press the TIMER key during operation, set temperature and time for the auto stop operation with the ▼▲ keys and press the ENTER key to complete.

Note, however, when you change the set time you need to set a time calculated by adding the time already passed to the time to be added.

Pressing the ▼ key during operation will display the set temperature, the operation mode and the remaining time on the SET TEMP. display.

In terms of the remaining time display 1.30 a blinking dot indicates count down and an illuminating dot indicates a wait status (while temperature is increasing or decreasing to the set temperature) during which the timer has stopped counting.

4. Operating procedures

Operating procedures (auto start operation)

Procedures for auto start operation

Used when you want to “start operation automatically after the set time.”

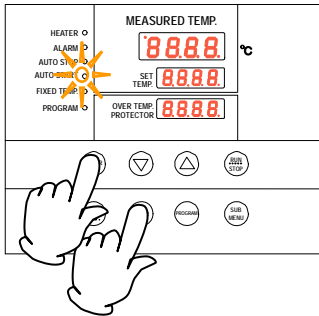

1. Setting an operation start time

- ① Press the **TIMER** key in the initial screen.
- ② The timer mode you used in the previous session is displayed on the SET TEMP. display. Pressing the **TIMER** key again to flash the timer mode. Pressing the **TIMER** key again to flash the next timer mode.

Select the character AStP **ASStP** that indicates the auto start operation and press the **ENTER** key.

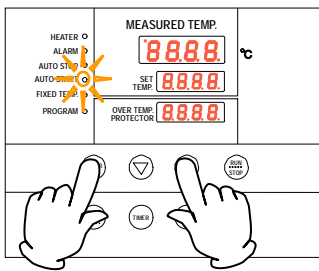

The character Sv **50** that indicate a set temperature is displayed on the MEASURED TEMP. display on which the current set temperature flashes and the AUTO START lamp flashes.

- ③ Set a temperature you want using the **▼▲** keys.
- ④ Press the **ENTER** key. The character tim **tim** that indicates the timer is displayed on the MEASURED TEMP. display and the current set time flashes on the SET TEMP. display and the AUTO START lamp flashes.
- ⑤ Set a time you want using the **▼▲** keys.

About the timer function

The maximum time that can be set for the timer is 999 hours 50 minutes.

Up to 99 hours 59 minutes, time can be set in minutes.

One hundred hours and over are set only in 10 minutes.

Keep the **▼▲** keys pressed to continuously change set time and you can quickly reach the time you want. Press the **▼▲** keys once at a time for fine adjustment.

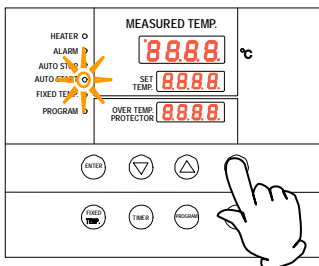

2. Starting timer operation

When you have set a time you want, start the **RUN/STOP** key for about one second.

Timer operation starts with the AUTO START lamp is illuminated.

4. Operating procedures

Operating procedures (auto start operation)

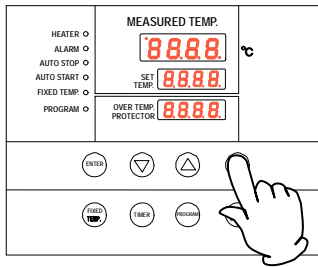

3. Stopping and ending timer operation

Operation starts automatically when the set time comes.

Press the **RUN/STOP** key for about one second to start or stop operation. The screen switches to the initial setting screen.

When you want to correct set temperature or set time, or confirm settings

When you want change the set temperature or a set time, press the **TIMER** key during operation, set temperature and time for the auto start operation with the **▼▲** keys and press the **ENTER** key to complete.

Note, however, when you change the set time you need to set a time calculated by adding the time already passed to the time to be added.

Pressing the **▼** key during operation will display the set temperature, the operation mode and the remaining time on the SET TEMP. display.

When operation has started after the auto start time, you cannot change the set time. In this case, first stop operation with the **RUN/STOP** key and repeat all settings.

4. Operating procedures

Preparing a program

Program operation

Used when you want to “operation at an increased or decreased temperature according to specific time.”

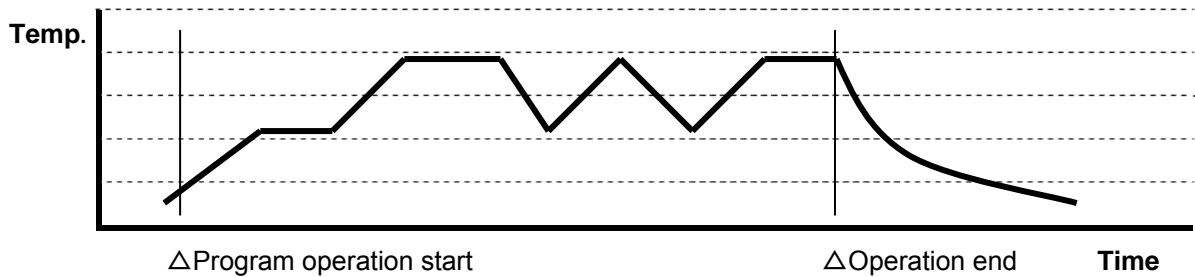

Preparing type

Up to six patterns of programs can be stored and input.

PrG1	—	One pattern of a program consisting of up to 30 steps can be made.
PrG2	PA t 1	Two patterns of a program consisting of up to 15 steps can be made.
	PA t 2	
PrG3	PA t 1	Three patterns of a program consisting of up to 10 steps can be made.
	PA t 2	
	PA t 3	

Before inputting a program

A program pattern must be registered (input) beforehand to start a program operation.

- ① Confirm the number of steps, temperatures for each step, and time on the program preparation sheet on pages 29~30 in the operation manual.
- ② Confirm the heating and cooling capacity of the device. Time needs to be set within the heating and cooling capacity of the device. For a device having a cooling or heating capacity of 3°C for every ten minutes, for example, it requires about 35 minutes lowering or raising by 10°C from the given temperature.
- ③ Make sure that the controller has an unused pattern that meets the number of steps to be programmed. However, when you want to use the repeat function, the number of steps to be repeated can be deducted from the number of steps for the unused pattern.

Useful function

You can use the useful repeat function when you want to repeat the same program steps. See page 28 for how to use the repeat function.

4. Operating procedures

Preparing a program

Heating · cooling time of the DVS model

Rough heating and cooling times of the DVSC model are as follows: Figures show required time for each of temperature zones. [It requires about 15 minutes to raise temperature from 100°C to 150°C.] However, be sure to conduct trial operation to determine a correct time since time required for stabilizing temperature needs to be added after the specific set temperature is reached.

Condition: Room temperature:25°C No load Exhaust port Closed 1/3 [Unit: minute]

	DVS402C		DVS412C		DVS602C		DVS612C	
	Temp. rise time	Temp. fall time	Temp. rise time	Temp. fall time	Temp. rise time	Temp. fall time	Temp. rise time	Temp. fall time
260°C	5	-	5	-	10	-	10	-
250°C	25	10	25	10	30	10	30	10
200°C	15	20	15	20	20	20	20	20
150°C	15	30	15	30	15	30	15	30
100°C	15	40	15	40	10	45	10	45
50°C	5	100	5	100	5	75	5	75

Making a program

Programming is explained using a program pattern shown below as an example here.

1. Example of program pattern

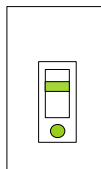
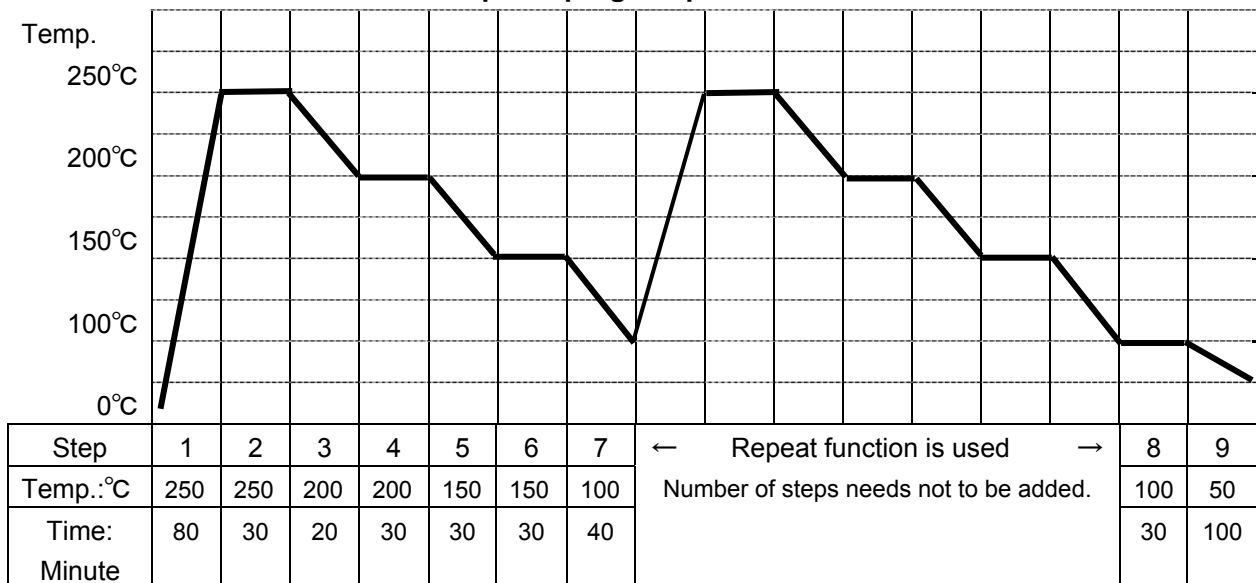

2. Turn power ON. (Turn the ELB to ON.)

When power is turned ON, the initial values will be displayed for about four seconds, then the initial screen will appear and the current bath temperature, operation mode character and the overheat prevention set temperature are displayed on each of the displays.

3. Selecting a program mode and a program pattern

① Press the **PROGRAM** key.

The program mode you used in the previous session is displayed on the SET TEMP. display.

Pressing the **PROGRAM** key again to flash the program mode.

Pressing the **PROGRAM** key again to flash the next program mode.

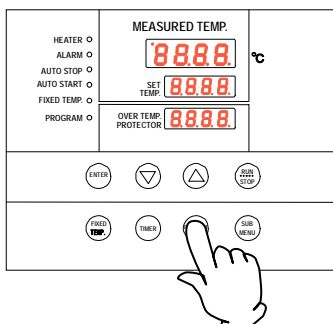

4. Operating procedures

Preparing a program

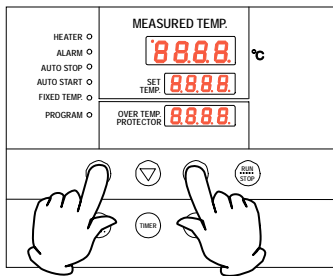

- ② Select a program mode you want and press the **ENTER** key.
- When PrG1 **PrG1** is selected, End **End** appears on the MEASURED TEMP. display and the number of steps registered flashes on the SET TEMP. display.
 - When PrG2 **PrG2** is selected, PAT **PAT** appears on the MEASURED TEMP. display and the pattern number flashes on the SET TEMP. display. To select a pattern select [1] or [2] with the **▼▲** keys. Pressing the **ENTER** key displays End on the MEASURED TEMP. display and the number of steps registered flashes on the SET TEMP. display.
 - When PrG3 **PrG3** is selected, select [1], [2], or [3] following the same procedures as for PrG2.

Since the sample program uses up to nine steps, input is allowed in any of the program modes of PrG1, PrG2, or PrG3.

Here, how to register a program is explained using PrG3 as an example.

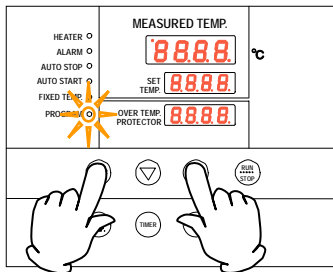

4. Registering a program (inputting a program)

- ① Select PrG3 following the previous section 3.
- ② Input the number of program steps, step temperature, and step time following the entries in the programming sheet.
- ③ Press the **ENTER** key. PAT number flashes. (End will appear when PrG1 is selected. Proceed to section ⑥.)
- ④ Select an unused pattern from PAT1, PAT2, or PAT3 with the **▼▲** keys.
- ⑤ Press the **ENTER** key. End appears and the number of steps “n” flashes.
*End is a character that indicates the total number of steps to be used. In the example, you will input “9.”
- ⑥ Input the total number of program steps to be used “9” with the **▼▲** keys.
- ⑦ Press the **ENTER** key. The character Sv-1 **Sv-1** that indicates the set temperature of the first step is displayed and the current set temperature flashes.
- ⑧ Set a temperature for the first step using the **▼▲** keys.

4. Operating procedures

Preparing a program

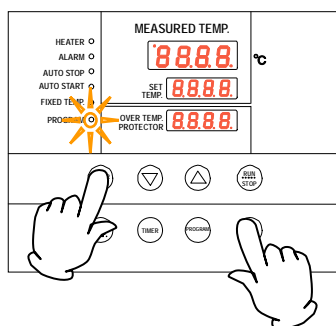

⑨ Press the **ENTER** key. The character t-1 **t-1** that indicates the set time of the first step is displayed and the current set time flashes.

* To set a time you need to know the heating capacity (or cooling capacity) of the unit beforehand.

* As an example, DVS 402C model requires about 75 minutes to increase room temperature to 250 °C. Therefore, assuming the current temperature to be 25 °C, heating capacity can be estimated roughly as three minutes to raise one °C meaning 75 minutes is necessary to increase to 250°C. In the example, the time has been estimated as 80 minutes with some allowances added.

* The maximum time that can be set for the timer of each step is 999 hours 50 minutes.

⑩ When time has been set, press the **ENTER** key. The temperature set character Sv-2 for the second step is displayed.

Input temperature and time of each step following the programming sheet.

⑪ When you want to repeat a certain program pattern (program repeat) in the middle of a program as in the example, a special procedure will be required. In this case, set time (t-7 in the example) for the step to be repeated (step 7 in the example) and press the **SUB MENU** key without pressing the **ENTER** key. Now you can enter the repeat function set mode.

*For operations of the program repeat function and how to register (input), follow procedures in “Program repeat operation” on page 28.

⑫ When setting the temperature and time for the final step has been completed, the screen returns to the initial setting screen.

Request for operation check

Prior to start actual operation with samples installed, be sure to perform no-load operation to check if the set temperature and the set time is appropriate.

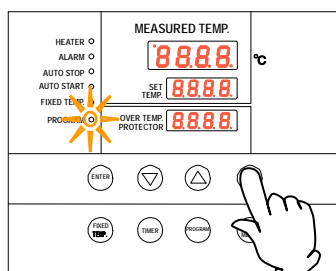

5. Starting the program operation

Press the **RUN/STOP** key for about one second. The set program operation starts.

The PROGRAM lamp illuminates and steps of the present operation will be displayed from the step St-1 **St-1** on the SET TEMP. display.

*Press the **▼** key during operation to check the set temperature and the remaining time for each step being operated on the SET TEMP. display.

4. Operating procedures

Preparing a program

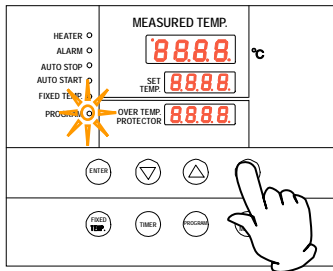

6. Terminating the program operation

When the program operation is terminated, the buzzer sounds for about five seconds to notify it to the user.

Character "End" appears on the SET TEMP. screen to indicate operation has ended.

Press the **RUN/STOP** keys to return to the initial setting screen.

About the timer function

The maximum time that can be set for the timer of each step is 999 hours 50 minutes.

Up to 99 hours 59 minutes, time can be set in minutes.

One hundred hours and over are set only in 10 minutes.

Keep the ▼▲ keys pressed to continuously change set time and you can quickly reach the time you want. Press the ▼▲ keys once at a time for fine adjustment.

When you want to correct setting errors or confirm settings

When you want to go back to previous steps for example to correct programming errors or to confirm settings, press the **FIXED TEMP.** key to return the setting screen to the previous screen.

Every time you press the **FIXED TEMP.** key you will go back by one step.

Note: Be sure to perform these operations on the program setting screen.

About wait of the program operation

When the program proceeds from a step to the next step and measured temperature has not reached or exceeded the set temperature after the set time for the step has elapsed, the next step will not start.

However, the unit has been set to proceed to the next step when the measured temperature is $\pm 3^{\circ}\text{C}$ to the set temperature.

4. Operating procedures

Program repeat operation

Using the program repeat function

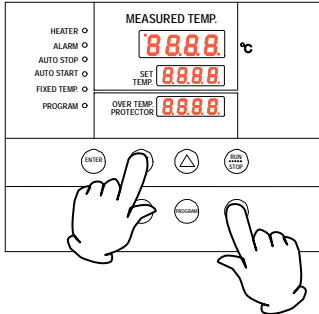

This section explains how to register a program pattern to be repeated (program repeat) during the program operation.

Using the program repeat function

This section explains how to register a program when you want to use the program repeat function in the middle of registering a program described in the previous section 4.

This procedure sets the number of step to return to “PS-n” and the number of repetition “Pc-n.” (n: step number when inputting the repeat operation)

- ① Set time (t-7 in the example) for the step to be repeated (step 7 in the example) and press the **SUB MENU** key without pressing the **ENTER** key. Now you can enter the repeat function set mode.
- ② Character “PS-n” that indicates “return destination select” of a program pattern is displayed on the MEASURED TEMP. display. In the example, the repeat function is input in the seventh step and PS-7 **PS-7** is displayed on the MEASURED TEMP. display.
You can input a number 1 to 7 of a step to return to on the SET TEMP. display and input the number of step (1 in the example) using the **▼▲** keys.
- ③ Then press the **SUB MENU** key.
- ④ Character “Pc-n” that indicates “number of repetitions” is displayed on the MEASURED TEMP. display. Input the number (2 in the example) using the **▼▲** keys.
- ⑤ Pressing the **SUB MENU** key again to move the screen to the next step. The screen moves to the Sv-8 registration screen in the example.

When you want to correct setting errors or confirm settings

No alteration is allowed in the middle of the repeat set mode.

If you want to go back to the previous step for example, to correct setting errors or to reconfirm settings you have made, finish repeat setting once, press the **FIXED TEMP.** key when the screen has changed to the temperature set screen for the next step to return the set screen to the previous screen and then redo repeat setting operations.

Note: Be sure to perform these operations on the program setting screen.

If you have any questions, ask the nearest sales office or the customer support center.

4. Operating procedures

Programming sheet

Make duplicates as necessary.

Registration destination	PrG1 PrG2 PrG3 PA1 PA2 PA3	Control No.	
Title of test		Y/M/D	
		Prepared by	

Program input values

	Set temperature (°C)	Set time (unit: minutes)	Repeat function input (Return destination: No. of times)
Step 1		:	:
Step 2		:	:
Step 3		:	:
Step 4		:	:
Step 5		:	:
Step 6		:	:
Step 7		:	:
Step 8		:	:
Step 9		:	:
Step 10		:	:
Step 11		:	:
Step 12		:	:
Step 13		:	:
Step 14		:	:
Step 15		:	:
Step 16		:	:
Step 17		:	:
Step 18		:	:
Step 19		:	:
Step 20		:	:
Step 21		:	:
Step 22		:	:
Step 23		:	:
Step 24		:	:
Step 25		:	:
Step 26		:	:
Step 27		:	:
Step 28		:	:
Step 29		:	:
Step 30		:	:

4. Operating procedures

Useful functions (calibration offset function)

Using the calibration offset function

Calibration offset function compensates any differences between the target temperature in the bath and the control temperature of the controller (sensor temperature.) The function can compensate in parallel to either plus or minus side for the whole temperature band of the unit. The lock can be set or released with the **SUB MENU** keys.

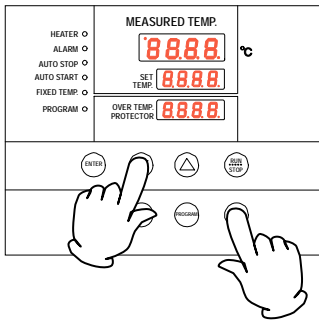
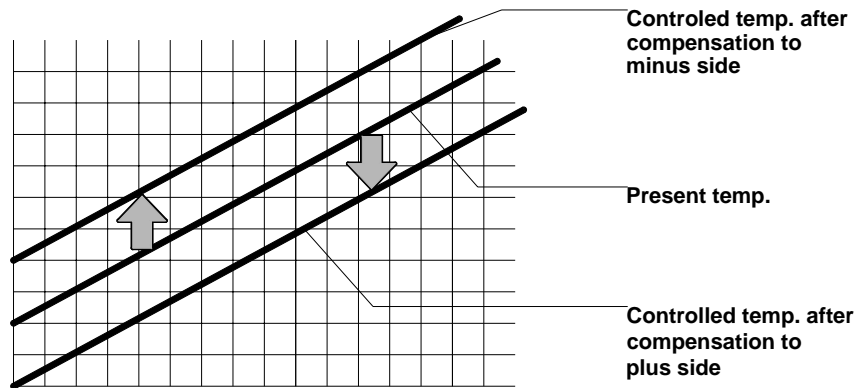

- ① Start operation at the target set temperature and confirm the temperature in the bath (sample temperature) with a temperature recorder after temperature has stabilized.
- ② Confirm the difference between the set temperature and that in the bath (sample temperature).
- ③ Press the **SUB MENU** key, select the character **CAL** `CAL` that indicates calibration offset using the **▼▲** keys and press the **ENTER** key.
- ④ Input the difference between the set temperature and that in the bath using the **▼▲** keys and press the **ENTER** key to complete setting.

* You can set either of + or - side up to +99°C and -99°C respectively for the offset compensation temperature.

When compensation is set for the - side, the MEASURED TEMP. display decreases by the compensation temperature while the temperature in the bath increases by the same amount.

When compensation is set for the + side, the MEASURED TEMP. display increases by the compensation temperature while the temperature in the bath decreases by the same amount.

* Since too large a compensation value may result in larger difference between the actual and indicated temperatures and may present a danger, consult our nearest sales office before entering a large compensation value.

* The device has, in addition to the calibration offset function, the two-point compensation function that adjusts offset for the lower temperature range and higher temperature range, for which adjustment temperatures have been input on shipping from the factory.

* Consult the nearest sales office before attempting validation work for the temperature adjusting device.

4. Operating procedures

Useful function (lock function)

Using the lock function

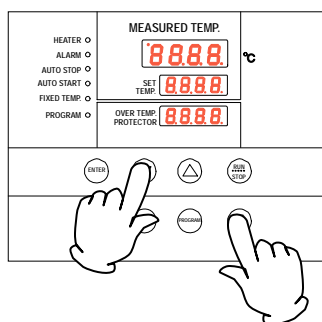

This function locks the set operation status.

The lock can be set or released with the **SUB MENU** key.

- ① Press the **SUB MENU** key, select the character Lock **Lock** that indicates setting lock using the ▼▲ keys and press the ENTER key.
- ② “OFF” is displayed on the SET TEMP. screen. To lock settings, change to “ON” using the ▲ key.
- ③ To release lock, press the **SUB MENU** key, select the character Lock **Lock** that indicates setting lock using the ▼▲ keys and press the **ENTER** key.
Lock is released when “off” is selected using the ▼ key and the ENTER key is pressed.

* When the lock function is “ON”, keys other than the **RUN/STOP** key and the **SUB MENU** key are locked.

5. Cautions on handling

Warning

1. About substances that cannot be used for the unit

-  Never use an explosive substance, a flammable substance or a substance containing them for this device.
An explosion or an electrical shock may result.
See section "13. List of dangerous materials" on page 43.

2. Prohibition of use/countermeasures when an error occurs

-  If smoke is emerges on the unit or an odd odor is felt, immediately turn the power supply off, remove the power cord (plug) from the power supply and contact your dealer or a Yamato sales office for inspection. Otherwise, a fire or an electrical shock may result. The user shall never attempt to repair the unit to avoid any possible dangers.

Caution

1. Do not place an object on the unit.

-  Do not place an object on the unit. Such an object may fall and cause a personal injury.

2. When a thunder is heard.

-  When a thunder is heard, turn the switch off and turn the power supply off immediately. Otherwise, a lightning strike may result and cause a malfunction or a fire.

3. When opening or closing the door

-  When opening or closing the door, do not put your hand or face close to the area the door moves (space). The door may touch your hand or face and causing an injury.

4. Do not operate the unit with the door open.

- 
 - When the unit is operated with the door open, proper temperature control is not possible and the heater may overheat pausing a possible danger. Be sure to operate the unit with the door closed.
 - After operation has been completed, do not leave the unit with its door open in order to, for example, cool down samples earlier. Heat from inside the bath may cause deformation of the control panel of a malfunction of the control devices.

5. Prohibition of use of corrosive samples

-  Although SUS304 stainless steel is used for components in the bath, note that they might corrode with strong acid. Door packing is made of silicon rubber. Note that silicon rubber packing may corrode with acid, alkali, oil or halogen-based solvent.

6. Always operate the unit at a correct ambient temperature.

-  The operating temperature range is room temperature range from +5~260°C above room temperature.
Never try to operate the unit outside the operating temperature range.

5. Cautions on handling



Caution

7. About placement of samples

- ⊘ Withstand load of the shelf boards included is approx. 15kg. Do not place a sample heavier than this withstand load.
When putting samples, arrange them as dispersed as possible.
Too many samples may prevent proper temperature control. To assure proper temperature precision, put samples with a space at least 30% of the shelf board area.

8. Do not put a sample on the bottom inside the bath.

- ! Never place a sample on the bottom, since if the unit is operated with a sample directly placed on the bottom of the internal bath, the optimal performance of the unit will not be attained, and temperature in the bath may increase excessively causing a malfunction.
Arrange samples on the shelf boards supplied and set the board on the shelf clamps.

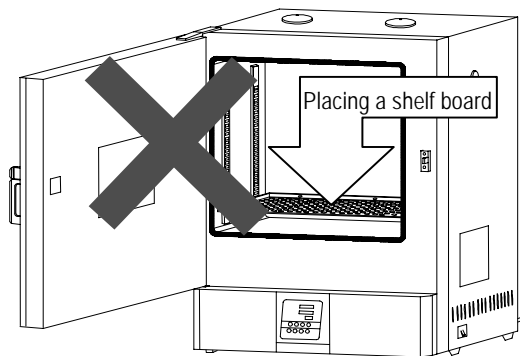

Do not place directly

9. About recovery from power outage.

- ! When the power is applied again after the unit has stopped due to power outage, the unit resumes operation with the status immediately before the power outage.

10. About two-tier stacking

- ! Stack the units in two tiers using the special stacking clamps included as optional accessories.
- ⊘ Do not stack unit in two tiers directly on each other.

11. After installation

- ! The unit might fall down by an earthquake or an impact resulting to a personal injury.
Take appropriate safety measures to prevent the unit from tripping over.

6. Maintenance procedures

Daily inspection/maintenance

Warning

- Be sure to pull out the power cord for the power supply unless necessary before trying to do inspection and maintenance works.
- Start these works after the device has returned to the normal temperature.
- Never try to disassemble the unit.

Caution

- Wipe off any dirt with a tightly wrung soft cloth. Never try to clean the unit with benzene, thinner or scouring powder, or rub with a scrubbing brush. Deformation, degradation or discoloration may result.

7. When the unit is not to be used for a long time or when disposing

When the unit is not used for a long time or when disposing



Caution

When the unit is not used for a long time

- Turn the main switch off and pull out the power cord (plug) from the power supply.



Warning

When disposing the unit

- Do not leave the unit in the area where children may have access.
- Be sure to remove handles before disposing the unit to prevent the doors from locking.
- In general, dispose the unit as a bulky waste.

Notes about disposition

Always pay attention to the preservation of the global environment.

- We highly recommend taking the unit apart as far as possible for separation or recycling to contribute to the preservation of the global environment. Major components and materials for the unit are as follows:

Names of major components	Material
Major mechanism part components	
Exterior	Steel plate SPCC (powder coating)
Interior	Stainless steel
Heat insulator	Glass wool
Door packing	Silicon rubber foam
Nameplates	Polyethylene (PET) resin film
Major electric parts	
Heater	SUS321 stainless steel pipe heater
Boards	Composite parts including boards, capacitor, resistor and transformer
Power cord, wire material and others	Synthetic rubber sheathed and resin sheathed wires





8. Troubleshooting

Safety device and error codes

The unit has the self diagnostic function with a controller and a separate safety device. Table below shows possible causes and measures when the safety device is triggered.

[Error codes]

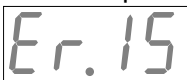
When a functional or mechanical abnormality occurs, the alarm lamp on the control panel comes on, an error code will be displayed and the alarm buzzer sounds. When an abnormality occurs, confirm the error code and immediately stop operation.

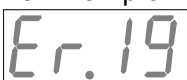
Safety device	Symptom	Possible causes and measures
Sensor error detected	Alarm lamp on  appears	<ul style="list-style-type: none"> ● Disconnection or other errors in the temperature sensor Contact our service department.
SSR short circuit detected	Alarm lamp on  appears	<ul style="list-style-type: none"> ● SSR short circuit Contact our service department.
Heater disconnection detected	Alarm lamp on  appears	<ul style="list-style-type: none"> ● Heater disconnection Contact our service department.
Memory error	Alarm lamp on  appears	<ul style="list-style-type: none"> ● Memory setting error Contact our service department.
Internal communication error	Alarm lamp on  appears	<ul style="list-style-type: none"> ● Internal communication or the temperature input circuit error Contact our service department.
Overheat	Alarm lamp on  appears	<ul style="list-style-type: none"> ● Activation of overheat prevention device Check the set temperature. Contact our service department if the unit will not recover.
Measured temperature error	Alarm lamp on ---- ---- appears	<ul style="list-style-type: none"> ● When the measured temperature is outside the displayable range Contact our service department.

8. Troubleshooting

When a malfunction is suspected

If any of the symptoms below occurs

Symptom	Check
The unit is not activated even if the power is turned on	<ul style="list-style-type: none">● Check if the power cord is connected to the power supply or to an outlet securely.● Check if power outage is occurring.
Temperature does not rise.	<ul style="list-style-type: none">● Check if the set temperature is below that in the bath.● Check if the power supply voltage has declined.● Check if the ambient temperature is low.● Check if cooling load for inside the bath is too large.
Temperature fluctuates during operation.	<ul style="list-style-type: none">● Check if the set temperature is appropriate.● Check if the power supply voltage has declined.● Check if ambient temperature fluctuates widely.● Check if cooling load for inside the bath is too large.
Displayed temperature differs from the measurement.	<ul style="list-style-type: none">● Check if the calibration offset setting is other than "0". Set it to "0." Confirm settings in "Useful functions (calibration offset function)" in page 31.

- ◆ If the symptom does not match any of the above, immediately turn the power switch on the main unit off, pull out the power cord (plug) from the power supply and contact your dealer or one of our sales offices.

9. After sales service and warranty

When requesting a repair

When requesting a repair

If any trouble occurs, immediately stop operation, turn the power switch off, pull out the power plug and contact your dealer or our sales office.

Information necessary for requesting a repair

- Model name of the product
 - Serial number
 - Date (y/m/d) of purchase
 - Description of trouble (as in detail as possible)
- } Refer to the warranty card or the nameplate on the unit.
See 3. Names and functions of parts on "page 10".

Be sure to indicate the warranty card to our service representative.

Warranty card (attached separately)

- Warranty card is given by your dealer or one of our sales offices and please fill in your dealer, date of purchase and other information and store securely.
- Warranty period is one full year from the date of purchase. Repair service for free is available according to the conditions written on the warranty card.
- For repairs after the warranty period consult your dealer or one of our sales offices. Paid repair service is available on your request when the product's functionality can be maintained by repair.

Minimum holding period of repair parts

The minimum holding period of repair parts for this product is seven years after end of production.

Repair parts here refer to parts necessary for maintaining performance of the product.

10. Specifications

Model		DVS402C	DVS412C	DVS602C	DVS612C
Performance	Operating temperature range	Room temperature +5°C~260°C			
	Temperature control precision	±1°C (at 260°C,exhaust port closed)			
	Temperature distribution precision	±5°C (at 260°C,exhaust port closed)			
	Temperature rise time	Approx.90minutes (room temperature ~260°C)			
Mechanism	Exhaust damper	Rotation damper with opening rate of 20% when closed			
	Heater	SUS pipe heater 115V 1.2 kW	SUS pipe heater 220V 1.2 kW	SUS pipe heater 115V 1.36 kW	SUS pipe heater 220V 1.36 kW
Control part	Controller	VS4 program controller			
	Control system	PID control of heater output with a micro computer			
	Setting system	Digital setting system with the dedicated menu keys and the ▼▲ keys			
	Operation modes	Fixed temperature operation, program operation, quick auto stop operation, auto stop operation, auto start operation.			
	Sensor	K thermocouple			
	Auxiliary functions	Lock function, calibration offset function, power outage compensation function			
Safety device	Self diagnostic function	Temperature sensor error, heater error, memory error, SSR short circuit, auto overheat prevention, measured temperature error			
	Protection device	Circuit Breaker, overheat prevention device (electronic type with an integrated controller)			
Standard	Outer dimensions (mm) (w x d x h)	560 × 601 × 820	560 × 601 × 820	710 × 651 × 870	710 × 651 × 870
	Inner dimensions (mm)*2 (w x d x h)	450 × 490 × 450	450 × 490 × 450	600 × 540 × 500	600 × 540 × 500
	Internal volume	99L	99L	162L	162L
	Weight	Approx. 48 kg	Approx. 48 kg	Approx. 63 kg	Approx. 63 kg
	Observation window (mm)	250 × 280 Reinforced glass			
	Power supply	115V 50 Hz 11.5A	220V 50 Hz 6.75A	115V 50Hz 13.1A	220V 50Hz 7.25A
Included items	Shelf board x 2 (withstand load approx. 15 kg/each)				
	Operating instructions, warranty card				

*Performance values are for the AC115V (DVS402C/DVS602C) and AC220V (DVS412C/DVS612C) power supply with no load at an ambient temperature of 23°C.

*Operating environmental temperature range for this device is 5°C~35°C.

11. Wiring diagram

DVS402C/602C

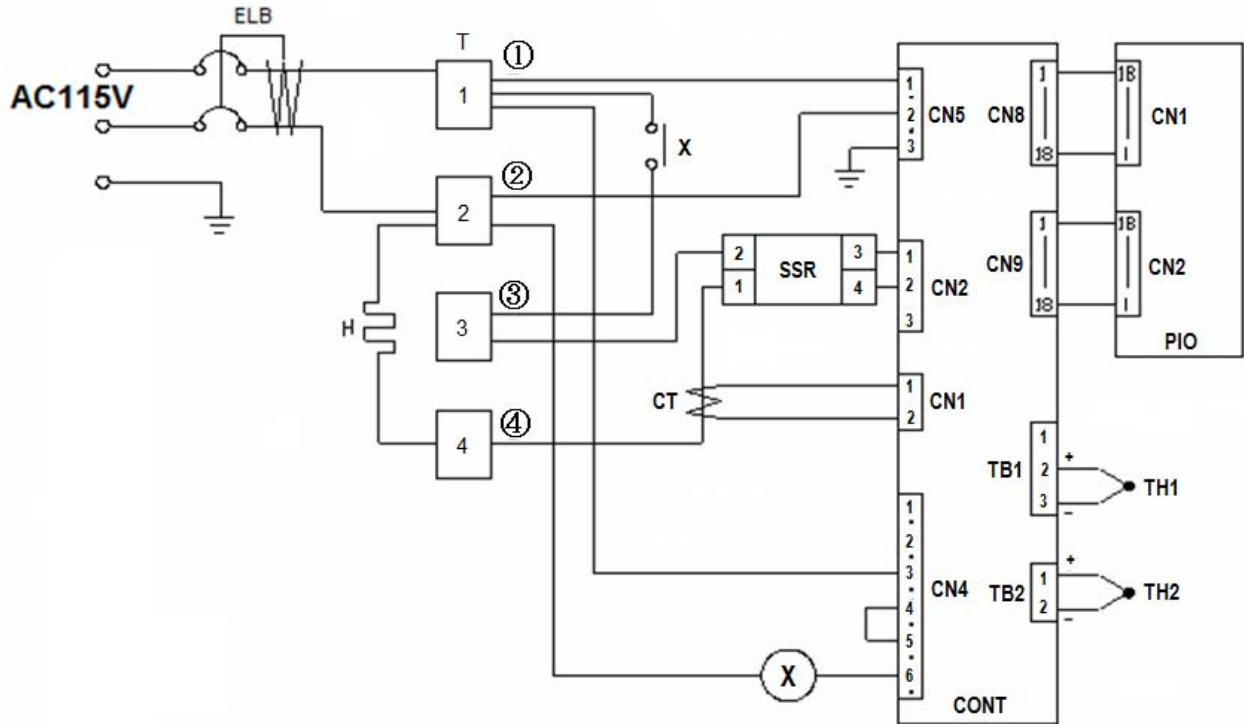

DVS412C/612C

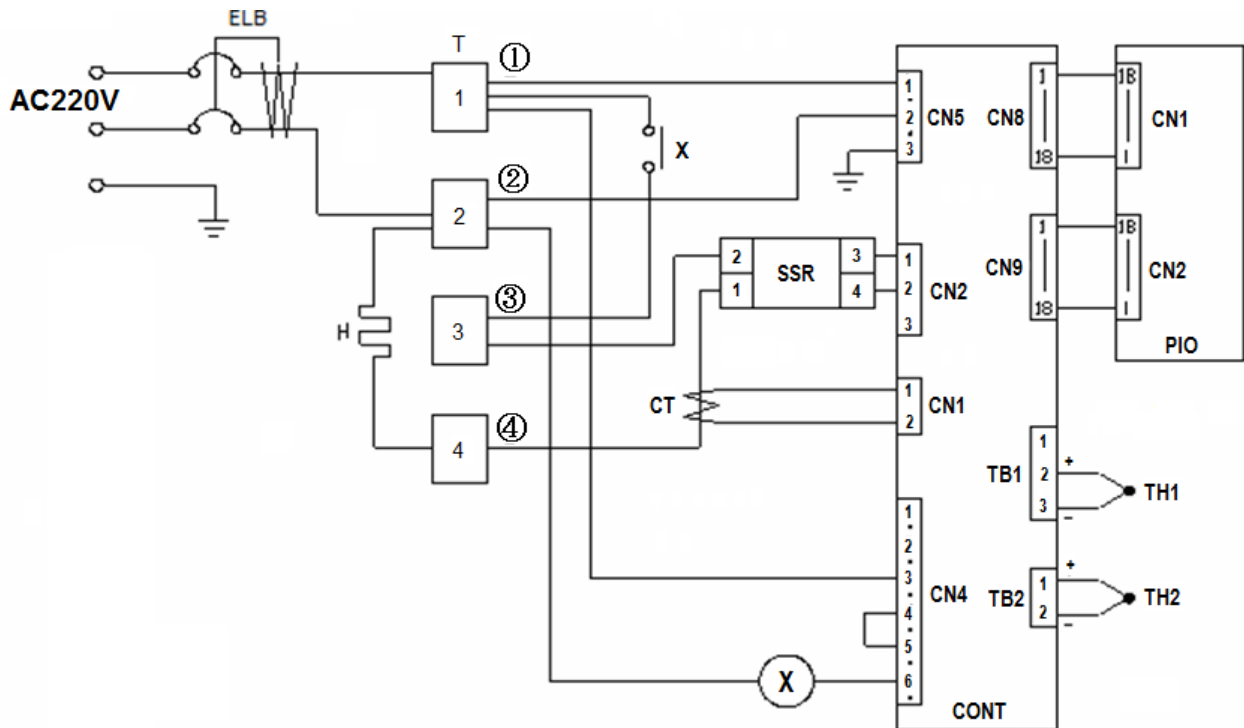

Symbol	Part name	Symbol	Part name
ELB	Earth Leakage Breaker	CONT	Control circuit board
T	Terminal block	PIO	Display circuit board
H	Heater	TH1	Temp. sensor
X	AC relay	TH2	Overheat prevention sensor
SSR	Solid state relay	CT	Current detection element

12. List of replacement parts

Common replacement parts for DVS402C/412C/602C/612C

Symbol	Part name		Specification	Maker	Code No.
TH1.2	K thermocouple		T0304.01-08 Φ 3.2*55*2000 DKN single	YSJ	SJA14012
CONT	Control Board		VS4	YSC	1020000053
PIO	Display Board		VS3.VS4	YSC	1020000051
	Signal Cable		VS1.VS2 300L	YSC	1130000008
X	AC Relay	DVS402C/602C	JQX-116F-2/110AL1HSTFW	YSJ	SJA04620
		DVS412C/612C	HF116F-2/220AL1HSTFW	YSJ	SJA06060
SSR	Solid state relay		XBPE4025C	YSJ	SJA13073
	Power cord		3*2mm ² 3m black/white/green USA plug	YSJ	SJA04480
ELB	ELB		KD-LS2123 30A 30mA	YSJ	SJA04529
CT	Current detection element		CTL-6-S-H	YSC	2170010005
H	Heater	(DVS402C)	T0301.01-07(115V 1200W)	YSJ	SJA24105
		(DVS412C)	T0301.03-07(220V 1200W)	YSJ	SJA04168
		(DVS602C)	115V 1360W DVS602(YSA)	YSJ	LT00020601
		(DVS612C)	T0301.03-13(220V 1360W)	YSJ	SJA04173

13. List of dangerous materials



Never use an explosive material, a flammable material or a material containing them for this device.

Explosive substance	Explosive substance	① Nitroglycol, glycerine trinitrate, cellulose nitrate and other explosive nitrate esters
		② Trinitrobenzen, trinitrotoluenem, picric acid and other explosive nitro compounds
		③ Acetyl hydroperoxide, methyl ethyl ketone peroxide, benzoyl peroxide and other organic peroxides
Flammable substances	Explosive substances	Metal "lithium", metal "potassium", metal "natrium", yellow phosphorus, phosphorus sulfide, red phosphorus, celluloids, calcium carbide (a.k.a, carbide), lime phosphide, magnesium powder, aluminum powder, metal powder other than magnesium and aluminum powder, sodium dithionous acid (a.k.a., hydrosulphite)
	Oxidizing substances	① Potassium chlorate, sodium chlorate, ammonium chlorate, and other chlorates
		② Potassium perchlorate, sodium perchlorate, ammonium perchlorate, and other perchlorates
		③ Potassium perchlorate, sodium perchlorate, ammonium perchlorate, and other inorganic perchlorates
		④ Potassium nitrate, sodium nitrate, ammonium nitrate, and other nitrates
		⑤ Sodium chlorite and other chlorites
		⑥ Calcium hypochlorite and other hypochlorites
	Flammable substances	① Ethyl ether, gasoline, acetaldehyde, propylene chloride, carbon disulfide, and other substances with ignition point at a degree 30 or more degrees below zero.
		② n-hexane, ethylene oxide, acetone, benzene, methyl ethyl ketone and other substances with ignition point between 30 degrees below zero and less than zero.
		③ Methanol, ethanol, xylene, pentyl acetate, (a.k.a.amyl acetate) and other substances with ignition point between zero and less than 30 degrees.
④ Kerosene, light oil, terebinth oil, isopentyl alcohol(a.k.a. isoamyl alcohol), acetic acid and other substances with ignition point between 30 degrees and less than 65 degrees.		
Combustible gas	Hydrogen, acetylene, ethylene, methane, ethane, propane, butane and other Substance which is a flammable gas at 15 degrees, one air pressure.	

14. Standard installation manual

*Install the product according to the following: (Confirm separately for optional items or special specifications)

Model	Serial number	Date	Installation mgr.(company name)	Installation mgr.	Judgment

No.	Item	Implementation method	TOC No. Reference page of the operating instruction manual	Judgment
Specifications				
1	Included items	Check for number of staffs against the included item field	10.Specifications field P.40	
2	Installation	<ul style="list-style-type: none"> Visual check of environmental conditions Caution: Take care for environment 	2. Before operating the unit <ul style="list-style-type: none"> On the installation site P.4 	
		<ul style="list-style-type: none"> Securing a space 		
Operation-related matters				
1	Source voltage	<ul style="list-style-type: none"> Measure the user side voltage (outlet) with a tester Measure voltage during operation (shall meet the specifications) Caution: Always use a plug that meets the specification for attaching to the ELB. 	2. Before operating the unit <ul style="list-style-type: none"> Be sure to connect the ground wire. P.4 Power supply is P.7 10.Specifications <ul style="list-style-type: none"> Specification - power supply P.40 	
2	Operation start	<ul style="list-style-type: none"> Starts operation Performs fixed temperature operation, auto stop operation, auto start operation, or program operation.	2. Before operating the unit P.4~8 <ul style="list-style-type: none"> Installation procedures... 4. Operating procedures P.13~32	
Description				
1	Operational descriptions	Explain operations of each component according to the operational instructions	4. Operating procedures P.13~32 <ul style="list-style-type: none"> Operating procedures 1. Safety precautions P.1~43 ~13.List of dangerous materials	
2	Error codes	Explain the customer about error codes and procedures for release according to the operational instructions	8. Troubleshooting sales P.37 ~9. After service and warranty 39	
3	Maintenance and inspection	Explain operations of each component according to the operational instructions	6. Maintenance procedures P.35 <ul style="list-style-type: none"> Daily inspection/maintenance 	
4	Completion of installation Entries	<ul style="list-style-type: none"> Fill in the installation date and the installation mgr. on the nameplate of the main unit Fill in necessary information to the warranty card and hand it over to the customer Explanation of the route for after-sales service 	9. After sales service and warranty P.39	

Responsibility

Please follow the instructions in this document when using this unit. Yamato Scientific has no responsibility for the accidents or breakdown of device if it is used with a failure to comply.

Never conduct what this document forbids. Unexpected accidents or breakdown may result in.

Note

- ◆ The contents of this document may be changed in future without notice.
- ◆ Any books with missing pages or disorderly binding may be replaced.

Instruction Manual
Constant Temperature Drying Oven
Model DVS402C/602C/412C/612C
Second Edition November 8, 2012

Yamato Scientific America, Inc.
925 Walsh Ave, Santa Clara, CA 95050
Tel:408-235-7725
For technical information and service,
call: 1-800-292-6286
<http://www.yamato-usa.com>