



Constant Temperature Oil Bath

Model

BOA200/310

Instruction Manual

- First Edition -

- Thank you for purchasing "Constant Temperature Oil Bath, BOA Series" of Yamato Scientific Co., Ltd.
- To use this unit properly, read this "Instruction Manual" thoroughly before using this unit. Keep this instruction manual around this unit for referring at anytime.

 **WARNING!**

Carefully read and thoroughly understand the important warning items described in this manual before using this unit.

Yamato Scientific Co. LTD.,

This paper has been printed on recycled paper.

◆ Cautions in Using with Safety	1
• Explanation.....	1
• Table of Illustrated Symbols	2
• Fundamental Matters of "WARNING!" and "CAUTION!"	3
◆ Before Using This Unit	5
• Requirements for Installation.....	5
• Preparation for Operation.....	9
◆ Description and Function of Each Part	11
• Main Unit	11
• Control Panel.....	12
• Characters of the Controller	13
◆ Operation Method	14
• Operation Mode and Function List	14
• Operation Mode, Function Setting Key and Characters.....	15
• Setting of Overheating Prevention Device	19
• Overheat Prevention, Emergency Stop Switch, Recovery from Electric Outage	20
• Calibration Offset Function.....	21
• Lock Function	22
• Attached Function	23
◆ Handling Precautions	26
◆ Maintenance Method	27
• Daily Inspection and Maintenance	27
◆ Long storage and disposal	28
• When not using this unit for long term / When disposing	28
◆ In the Event of Failure	29
• Safety Device and Error Code.....	29
• Trouble Shooting	30
◆ After Service and Warranty	31
◆ Specification	32
◆ Wiring Diagram	33
• BOA200.....	33
• BOA310.....	34
◆ Replacement Parts Table	35
◆ Reference	36
• List of Dangerous Substances	36
◆ Installation Standard Manual	37

Explanation

MEANING OF ILLUSTRATED SYMBOLS

Illustrated Symbols

Various symbols are used in this safety manual in order to use the unit without danger of injury and damage of the unit. A list of problems caused by ignoring the warnings and improper handling is divided as shown below. Be sure that you understand the warnings and cautions in this manual before operating the unit.

 **WARNING!** If the warning is ignored, there is the danger of a problem that may cause a serious accident or even fatality.

 **CAUTION!** If the caution is ignored, there is the danger of a problem that may cause injury/damage to property or the unit itself.

Meaning of Symbols



This symbol indicates items that urge the warning (including the caution). A detailed warning message is shown adjacent to the symbol.



This symbol indicates items that are strictly prohibited. A detailed message is shown adjacent to the symbol with specific actions not to perform.



This symbol indicates items that should be always performed. A detailed message with instructions is shown adjacent to the symbol.

Table of Illustrated Symbols

Warning



Warning,
generally

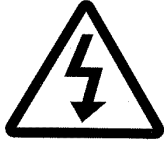

Warning,
high voltage



Warning,
high temperature



Warning,
drive train



Warning,
explosive

Caution



Caution,
generally



Caution,
electrical shock



Caution,
scald



Caution,
no road heating



Caution,
not to drench



Caution,
water only



Caution,
deadly poison

Prohibit



Prohibit,
generally



Prohibit,
inflammable



Prohibit,
to disassemble



Prohibit,
to touch

Compulsion



Compulsion,
generally



Compulsion,
connect to the
grounding
terminal



Compulsion,
install on a flat
surface



Compulsion,
disconnect the
power plug



Compulsion,
periodical
inspection

Cautions in Using with Safety

Fundamental Matters of "WARNING!" and "CAUTION!"

WARNING!

Do not use this unit in an area where there is flammable or explosive gas

Never use this unit in an area where there is flammable or explosive gas. This unit is not explosion-proof. An arc may be generated when the power switch is turned on or off, and fire/explosion may result. (Refer to page 36 "List of Dangerous Substances".)

Always ground this unit

Always ground this unit on the power equipment side in order to avoid electrical shock due to a power surge.

If a problem occurs

If smoke or strange odor should come out of this unit for some reason, turn off the circuit breaker right away, and then disconnect the power plug. Immediately contact a service technician for inspection. If this procedure is not followed, fire or electrical shock may result. Never perform repair work yourself, since it is dangerous and not recommended.

Do not use the power cord if it is bundled or tangled

Do not use the power cord if it is bundled or tangled. If it is used in this manner, it can overheat and fire may be caused.

Do not process, bend, wring, or stretch the power cord forcibly

Do not process, bend, wring, or stretch the power cord forcibly. Fire or electrical shock may result.

Regular inspection

Do not leave the dust and waste on wiring terminal part or electric parts. Inspect periodically. Otherwise it may be the cause of a fire.

Substances that can not be used

Never use explosive substances, flammable substances and substances that include explosive or flammable ingredients in this unit. Explosion or fire may occur. (Refer to page 36 "List of Dangerous Substances".)

Do not disassemble or modify this unit

Do not disassemble or modify this unit. Fire or electrical shock or failure may be caused.

Do not touch high-temperature parts

The inside of the body or the door may become hot during and just after operation. It may cause burns.

Fundamental Matters of "WARNING!" and "CAUTION!"



CAUTION!



During a thunder storm

During a thunderstorm, turn off the power key immediately, then turn off the circuit breaker and the main power. If this procedure is not followed, fire or electrical shock may be caused.



Electric outage

Although operation of this unit will be stopped in case of electric outage, turn off the breaker in that case for safety.

Requirements for Installation

WARNING!

1. Always ground this unit



- Be sure to connect the earth wire (the green cable of power cord) to the grounding conductor or ground terminal to prevent accidents caused by electric leakage.
- Do not connect the earth wire to gas or water pipes. If not, fire disaster may be caused.
- Do not connect the earth wire to the ground for telephone wire or lightning conductor. If not, fire disaster or electric shock may be caused.
- Please consult your local electrical contractor for power connecting work.
- ❖ BOA200 type is specified for single phase 100V. Since it is for large capacity of 21A, prepare the switchboard with a grounding terminal of exclusive use.
- ❖ BOA310 type is specified for single phase 200V, and the capacity is 23A. Prepare the switchboard with a grounding terminal of exclusive use.

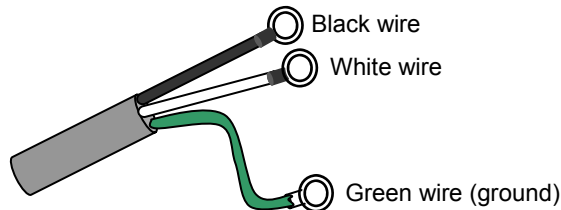

2. Choose a proper place for installation



- Do not install this unit in a place where:
 - ◆ Rough or dirty surface.
 - ◆ Flammable gas or corrosive gas is generated.
 - ◆ Ambient temperature above 35°C.
 - ◆ Ambient temperature fluctuates violently.
 - ◆ There is direct sunlight.
 - ◆ There is excessive humidity and dust.
 - ◆ There is a constant vibration.
 - ◆ Winds from the air conditioner, etc. hit the sample container directly.
 - ◆ Without a ventilation system.



- Confirm that there is no flammable substance around each product, and secure the larger space than that of the following figure.

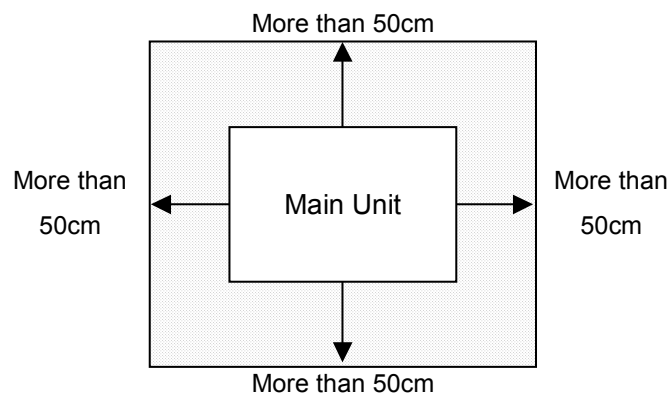

Requirements for Installation

3. Do not use this unit in an area where there is flammable or explosive gas



- Never use this unit in an area where there is flammable or explosive gas. This unit is not explosion-proof. An arc may be generated when the power switch is turned ON or OFF, and fire/explosion may result.



- To know about flammable or explosive gas, refer to page 36 "List of Dangerous Substances".

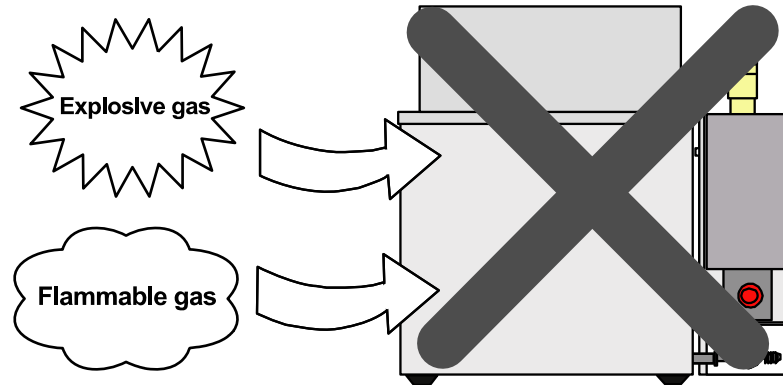

4. Installation of exhaust, ventilator, and fire extinguisher



- The lamp black of silicone oil generated by heating has inflammability, and may cause a fire. Also, if silicone oil is heated to high temperature, it may generate harmful gas etc. When using the device, be sure to install an exhaust, a ventilator, and a fire extinguisher.

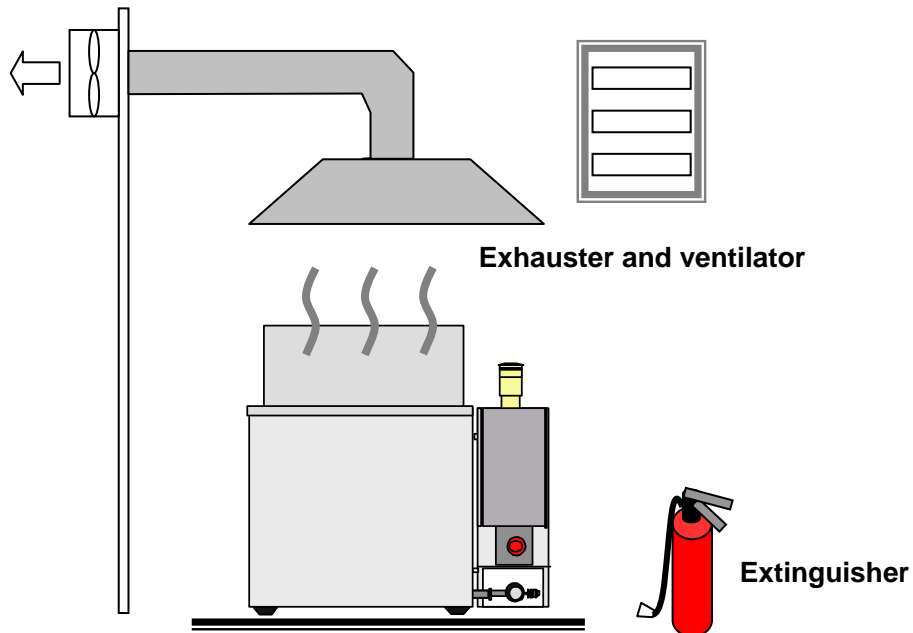

Requirements for Installation

CAUTION!

5. Do not modify



- Modification of this unit is strictly prohibited. This could cause a failure.

Modification

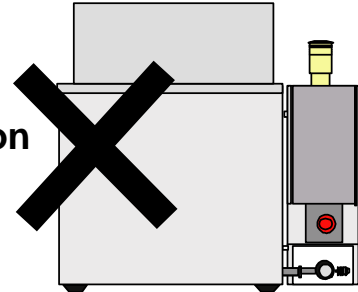

6. Installation on horizontal surface



- Place this unit as flat a place as possible. If the four feet are not in uniform contact with the floor surface, noise or vibration may result. Additionally, the unit may cause a problem or malfunction.

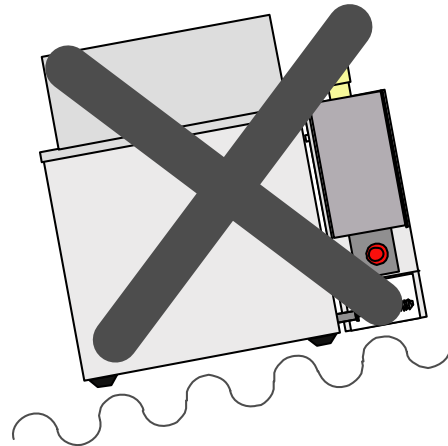

7. Choose a correct power distribution board or receptacle



- Choose a correct power distribution board or receptacle that meets the unit's rated electric capacity.

Electric capacity: BOA200: 100V AC, 21A
BOA310: 200V AC (single phase), 23A

NOTE)

There could be the case that the unit does not run even after turning ON the power. Inspect whether the voltage of the main power is lowered than the specified value, or whether other device(s) uses the same power line of this unit. If the phenomena might be found, change the power line of this unit to the other power line.

8. Before/after installing



- It may cause injure to a person if this unit falls down or moves by the earthquake and the impact. etc..To prevent, take measures that the unit cannot fall down, and not install to busy place.

Requirements for Installation

9. Handling of power code



- Do not entangle the power cord. This will cause overheating and possibly a fire.
- Do not bend or twist the power cord, or apply excessive tension to it. This may cause a fire and electrical shock.
- Do not lay the power cord under a desk or chair, and do not allow it to be pinched in order to prevent it from being damaged and to avoid a fire or electrical shock.
- Keep the power cord away from any heating equipment such as a room heater. The cord's insulation may melt and cause a fire or electrical shock.



- If the power cord becomes damaged (wiring exposed, breakage, etc.), immediately turn off the power at the rear of this unit and shut off the main supply power. Then contact your nearest dealer for replacement of the power cord. Leaving it may cause a fire or electrical shock.
- Connect the power plug to the receptacle which is supplied appropriate power and voltage.

Preparation for Operation



Operating notice

Note the following when operating.

1. Connect the power supply to the switchboard which has enough capacity.
2. Do not move the device while operating.
3. Operate with thick leather gloves to avoid any burns.
4. Inside of the bath and the device are heated during and after operation. Do not touch by hands. Especially the edge of the bath will be highly heated.
5. Do not operate the drain valve until the oil temperature goes down to below 45°C.
6. Do not execute unmanned operation with high temperature since it is dangerous.
7. Applicable mediums to this device are water (ion exchange water and distilled water) when used as a water tank, and silicone oil when used as an oil tank. Do not use any other fluid than water or silicone oil.
8. Shared use of the bath as a water tank and an oil tank is dangerous and it may cause an unexpected accident.
9. Do not use the device outdoors.



Applicable mediums

When using as a water tank

This device can be used as a water tank with the normal temperature - around 95°C. In the use as a water tank, the use of ion exchange water or distilled water is recommended in order to prevent scale adhesion on the heater or the inner tub. However, the optimal setup of the temperature at the time of shipment is set for an oil tank use, and the accuracy of temperature control and temperature distribution will be worsen in water use.

When using as an oil tank with silicone oil

Select silicone oil of heat resistance and open system (heat-resistant dimethyl silicone oil) which is only for heat media. The adhesion should be below 100 mm²/s (cSt).

Recommended silicone oil:

Temperature for use Below 200°C TOSHIBA Silicone product TSF458-50

Temperature for use 200°C~270°C TOSHIBA Silicone product TSF458-100

Characteristics of silicone oil		
Manufacturer	TOSHIBA Silicone	TOSHIBA Silicone
Recommended temperature	Below 200°C	200 to 270°C
Product name	TSF458-50	TSF458-100
Appearance	Light yellow transparent	Light yellow transparent
Gravity (25°C)	0.961	0.963
Adhesion (25°C) mm ² /s (cSt)	50	100
Volatilization (150°C, 24h) %	0.3	0.3
Adhesion temperature coefficient	0.59	0.59
Flash point (°C)	325	342
Pour point (°C)	Below -50°C	Below -50°C
Adhesion increase rate (300°C, 168h) %	40	35

The degradation speed (adhesion change) of silicone oil differs by the temperature. With TSF 485-100 which is used at the temperature over 200 °C, changes can be found in about 1000 hours at 250°C, and 100 hours at 270°C, although no adhesion changes can be found at 200°C for normal use. Contact the silicone maker for details at the time of purchase.

Preparation for Operation

Oil/Water supply amount to inner bath

The maximum amount of silicone oil and water should be below 50mm from the top edge of the inner bath. The minimum amount should be above 100mm from the bottom. This unit has the function which senses maximum and minimum level for safety and turns off the heater. Note that if the supplied amount is too much or too little, level sensor switch will be turned on, the operation will be stopped, and it will not keep heating.

Be careful about the amount of silicone oil supply

Silicone oil has large heat expansion and has a possibility of overflowing from inner bath by being heated. When pouring oil into the inner bath, it is necessary to deduct the expanded amount beforehand.

Example: The formula of the amount of oil supply in case of using TSF 485-100 is as follows.

$$\text{Oil increasing amount} = (\text{setting temperature} - \text{current temperature}) \times \text{oil amount} \times 0.00098$$

In case that the setting temperature is 270°C, current oil temperature is 23°C, and oil amount is 37L, the calculation will be

$$(270^{\circ}\text{C} - 23^{\circ}\text{C}) \times 37 \times 0.00098 = 8.956\text{L}$$

In the above case, 28L of oil should be supplied beforehand. The relation between the amount of oil supply and the fluid level with BOA200/310 is as follows.

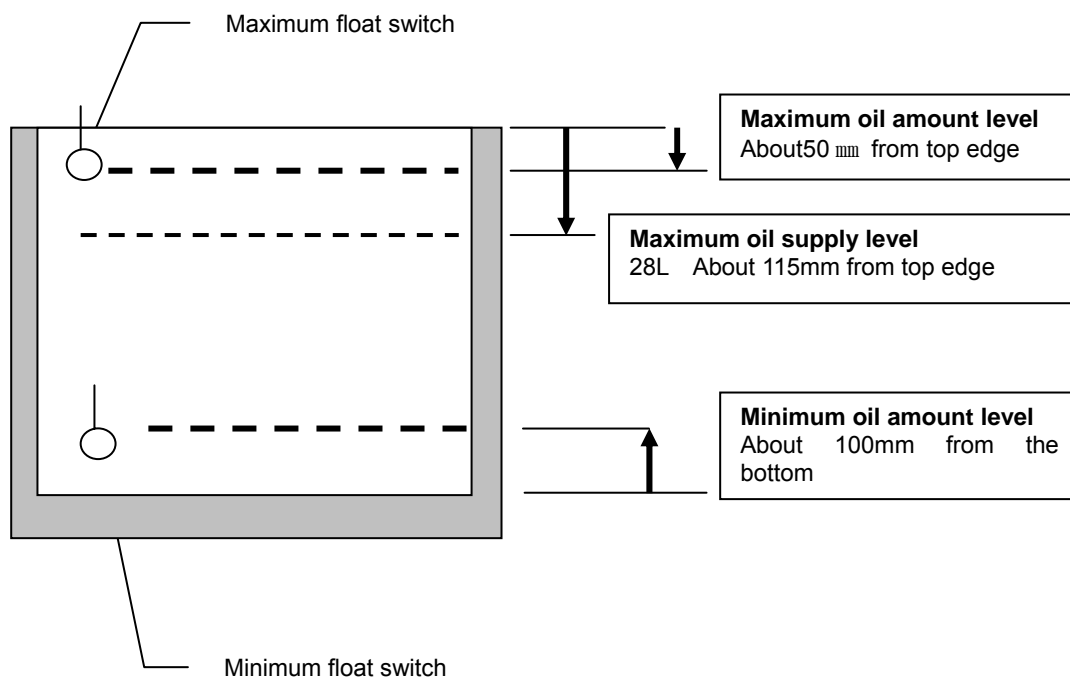

Description and Function of Each Part

Main Unit

Front view

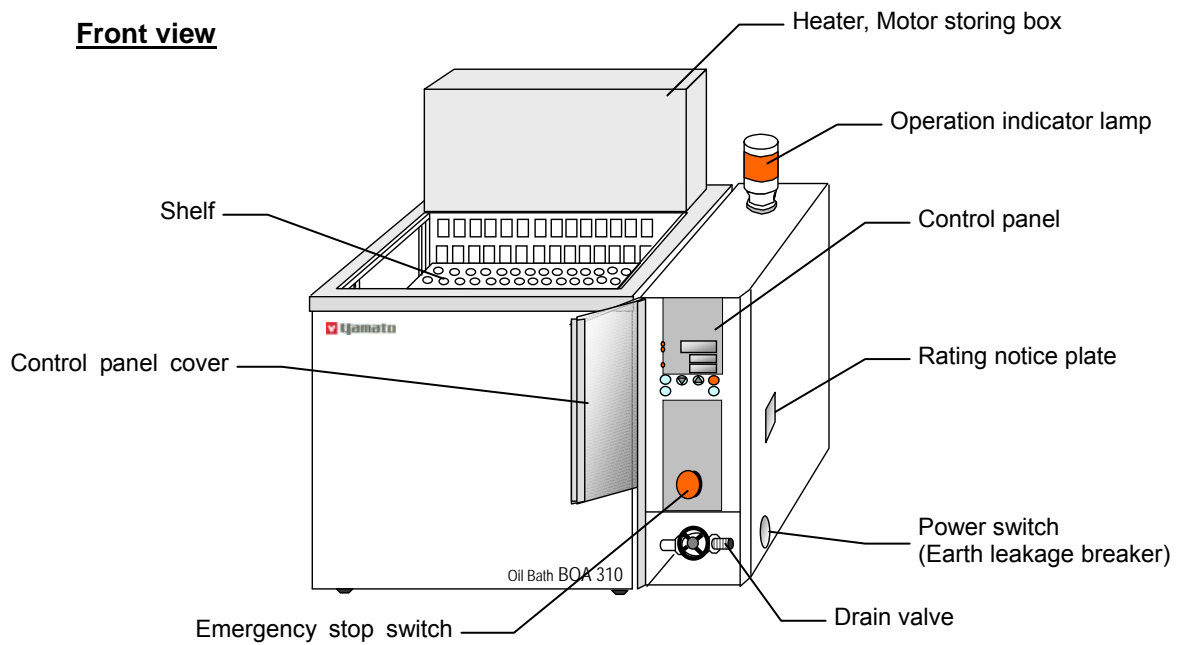

Rear view

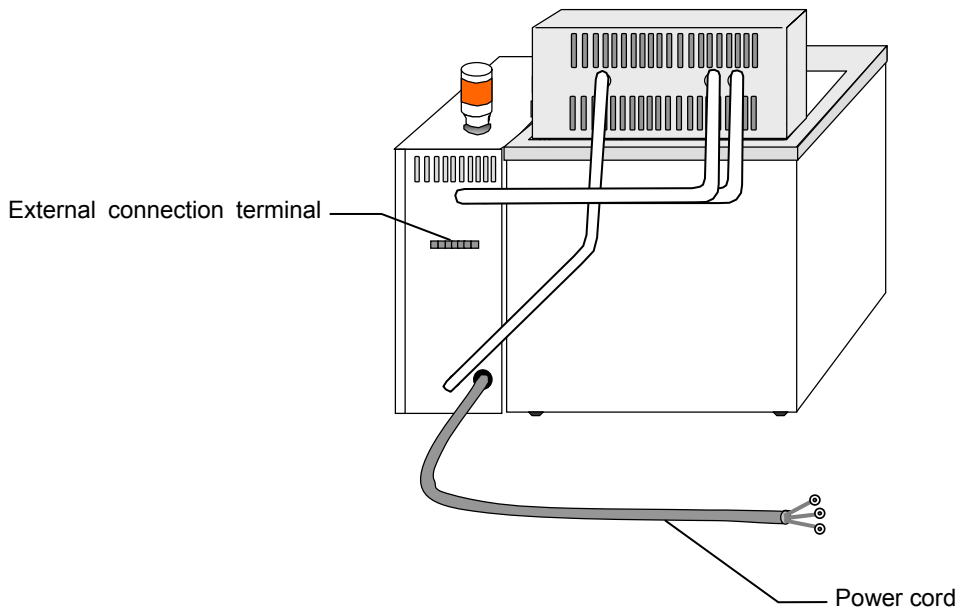

Description and Function of Each Part

Control Panel

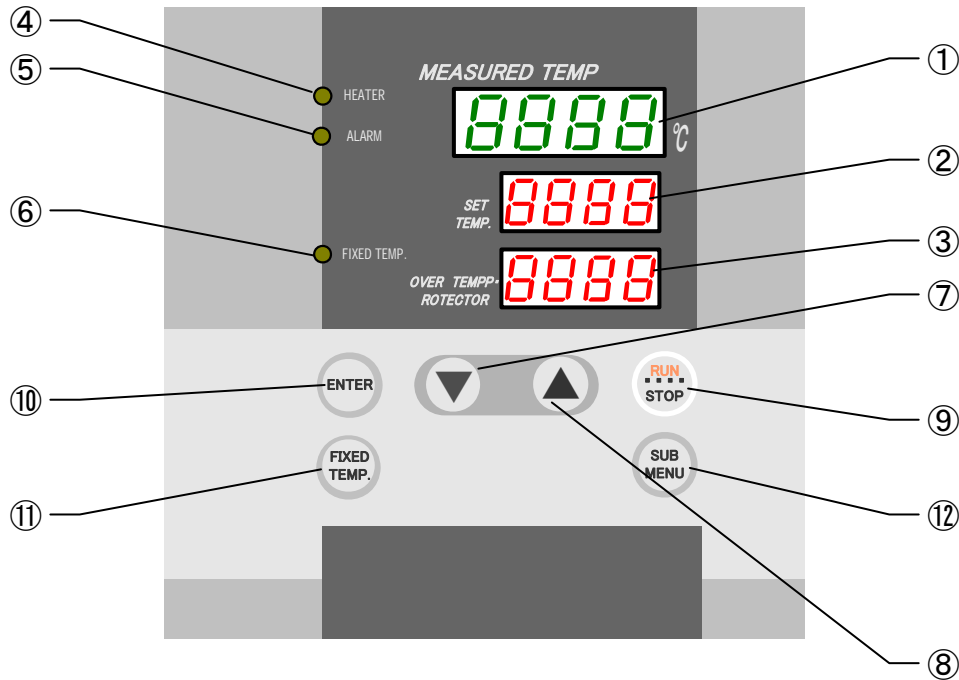





No.	Name	Printed string	Discription
①	Measured temperature screen	MEASURED TEMP.	Displays the measured temperature in the bath.
②	Setting temperature screen	SET TEMP.	Displays the setting temperature.
③	Overheating prevention screen	OVER TEMP.PROTECTOR	Displays the setting temperature for overheating prevention device.
④	HEATER OUTPUT lamp	HEATER	Turned on at the time of heater output.
⑤	ALARM lamp	ALARM	Lights and sounds for the notice of abnormalities.
⑥	FIXED TEMP. lamp	FIXED TEMP.	Turned on when selecting fixed temperature operation.
⑦	VALUE DOWN key	▼	Reduces the setting value.
⑧	VALUE UP key	▲	Raises the setting value.
⑨	RUN/STOP key	RUN/STOP	Used for Run/Stop operation.
⑩	ENTER key	ENTER	Confirms the setting value.
⑪	FIXED TEMP. MENU key	FIXED TEMP.	Selects fixed temperature operation and temperature setting.
⑫	SUB MENU key	SUB MENU	The key to select menu for Key lock, Calibration offset, Overheating prevention temperature setting.

Description and Function of Each Part

Characters of the Controller

The characters controller shows are as follows:

Character	Identifier	Name	Purpose
	FiX	Fixed Temperature Setting Mode	A Display which means Fixed Temp mode has been selected. Displayed when FIXED TEMP. key is pressed. (Refer to P.16)
	Sv	Temperature Setting	Shows that it is in Temperature setting mode.
Characters for SUB MENU			
	oH	Overheating Prevention Setting	Shows that it is in Temperature setting mode for Overheating prevention device. (Refer to P.19)
	cAL	Calibration Offset Setting	Shows that it is in Calibration offset temperature input mode. (Refer to P. 21)
	LoCK	Key Lock	Shows that it is in the Key Rock mode so that setting value cannot be changed. (Refer to P.22)

* Also refer to P.15 "Operation Mode, Function Setting Key and Characters".

Operation Mode and Function List

The operation modes of this unit are as follows;

Name	Description	Page
Fixed Temperature Operation	When RUN/STOP Key is pressed for a second, the operation will start. When RUN/STOP Key is pressed for a second again, the operation will be stopped.	16

The sub functions of this unit are as follows;

Name	Description	Page	
Overheating prevention function	1	Auto overheating prevention function This function is set to be automatically activated (auto reset) when the temperature exceeds the setting temperature by 6°C.	19
	2	Overheating prevention device Though the device shares power source, display, and key input with the controller, it has independent temperature measurement circuit, CPU, sensor and output circuit. Overheating prevention temperature can be set using the operation panel. The unit stops operation when the device is activated. The unit starts operation again when the POWER switch is pressed again (manual reset).	
	3	Independent overheating prevention device Fluid pressure typed overheating prevention device is built in. Its operation temperature is fixed at 230°C with BOA200 type, and at 300°C with BOA310 type. It starts operating if the overheating prevention function of "1" and "2" should not start.	
Calibration offset function	This calibration offset function is for calibrating the difference occurred between the required in-bath temperature and control temperature (sensor temperature) of the controller. This unit can be calibrated toward either plus side or minus side of the whole temperature range.	21	

Operation Mode, Function Setting Key and Characters

The operation mode setting and function setting use the key operation and characters show in the following figure.

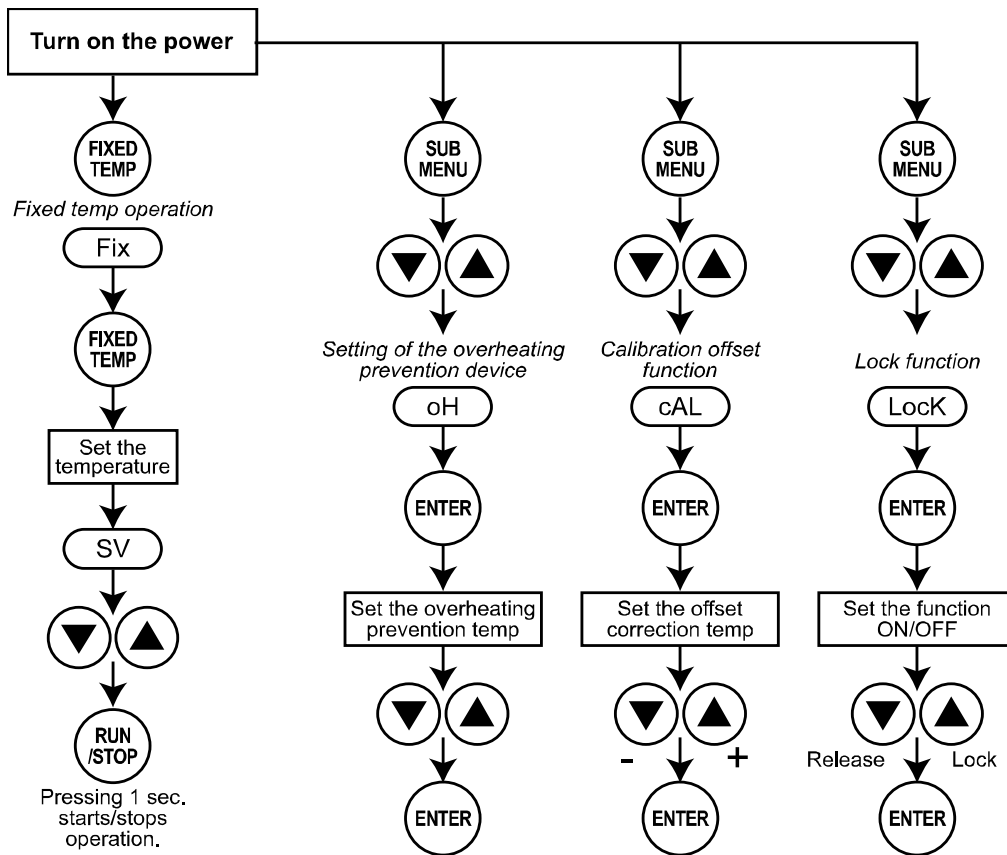

Fixed Temperature Operation

Fixed temperature operation procedure

1. Turn on the power (turn on the breaker in front)

- Current version of the software is displayed for about four seconds after turning on the power. The screen then displays the initial setting. The current temperature in bath, operation mode character and setting temperature of overheating prevention device are displayed on respective screens.

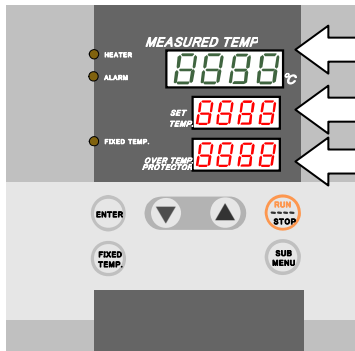

Measured temperature screen (MEASURED TEMP.)

Displays the current temperature in bath.

Setting temperature screen (SET TEMP.)

Displays the operation mode character.

Overheating prevention screen (OVER TEMP.)

Displays the setting temperature of overheating prevention device.

- ❖ Refer to P.13 for the characters of operation mode.

2. Select the operation mode

- Press the FIXED TEMP. key to display "FIX", which indicates the fixed temperature operation, on the setting temperature screen.

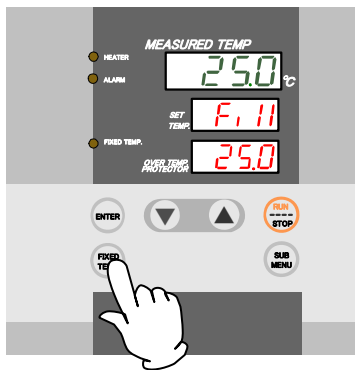

3. Set the temperature

- ① Press the FIXED TEMP. key again. The measured temperature screen displays the character "Sv" which indicates the temperature setting, and the setting temperature screen displays the current setting temperature with blinking. Also The FIXED TEMP. lamp blinks.
- ② Set the temperature by pressing the "▼▲".

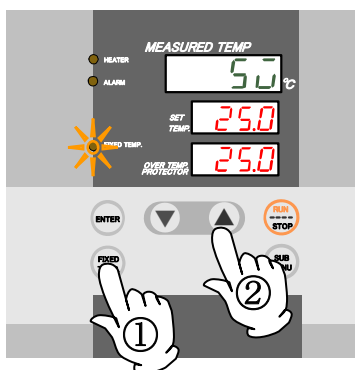

Fixed Temperature Operation

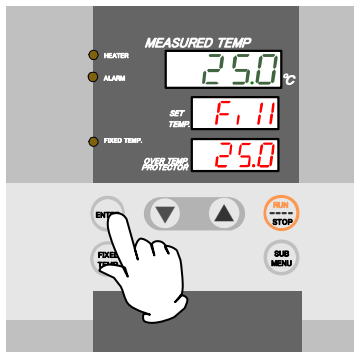

4. Confirm the setting temperature by pressing ENTER key

- After setting the temperature, press ENTER Key to confirm the setting temperature. The screen returns to the initial setting screen.
- The measured temperature screen displays the inner bath temperature, and the setting temperature screen displays the character "FiX" which indicates the fixed temperature operation.

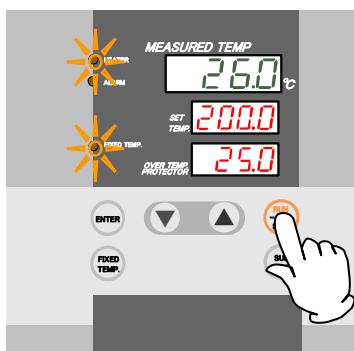

5. Start operation

- Press the RUN/STOP key for about one second. The unit starts operation and the blinking FIXED TEMP. lamp lights on.
- The HEATER lamp lights on, and the temperature goes up.
- The operation indicator lamp installed on the unit lights on to show that it is under operation.
- ❖ Operation can still be started by pressing directly RUN/STOP key for a second without pressing ENTER key after setting the temperature with ▼▲ key as shown in the item 3 on the previous page.

The operation indicator lamp on the main unit lights on when the RUN/STOP key is pressed and the operation is started. The lamp turns off when the key is pressed and the operation is stopped.

Operation indicator lamp

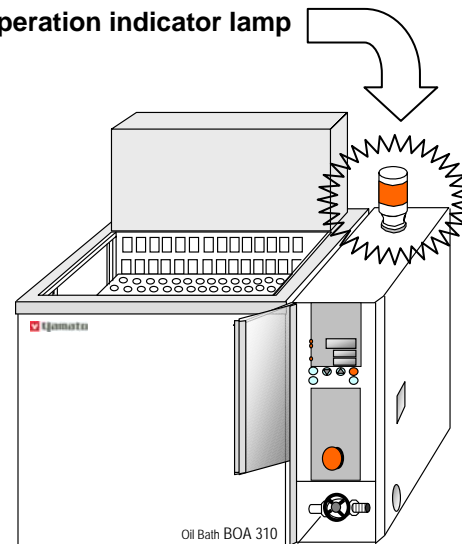

Fixed Temperature Operation

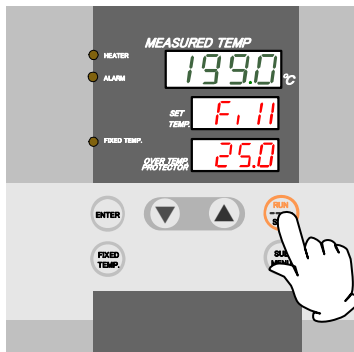

6. Stop operation

- Press the RUN/STOP key for about one second.
- The unit stops operation and the FIXED TEMP. and HEATER lamp light off. The screen returns to the initial setting screen.
- The operation indicator lamp installed on the unit turns off.

To fix the setting error and confirm the setting value...

To fix the setting error and confirm the setting value, press FIXED TEMP. key. Setting temperature will be displayed on the setting temperature screen.

To change the setting temperature while operating...

To change the setting temperature, press the FIXED TEMP. key while operating. It will be in setting mode, and the setting will be able to be changed.

After changing the temperature by ▼▲ key, press ENTER. It will operate with the new temperature.

Setting of Overheating Prevention Device

As a security device for temperature overheating prevention, the controller is equipped with automatic overheating prevention function (auto-recovery) and overheating prevention device (manual recovery). The overheating prevention device shares power supply, display, and key input part with controller, but it consists of independent temperature measurement circuit, CPU, sensor, and output circuit.

For other safety measures, fluid pressure-type overheating prevention device (manual recovery) of 230°C fixed operation temperature is equipped to BOA200, and 300°C fixed operation temperature to BOA310. Triple safety measures are taken.

Setting range/function

The unit has failsafe functions against overheating. One of them is built in the controller and previously set at factory shipment so to be automatically activated when the temperature exceeds the setting temperature of temperature controller by 6°C, where the heater repeats on and off. The other is united with the controller, which can be set by operating the keys on the controller.

The setting range of latter is from 0°C to "the maximum setting temperature of unit plus 50°C". The standard setting temperature of the overheating prevention device is "setting temperature of unit plus 10°C".

In case the temperature in bath exceeds the setting temperature of controller to reach to that of overheating prevention device, the circuit is shut off and "Er19" is displayed with blinking on the screen of controller with buzzer sound.

If the device is once activated, "Er19" continues to be displayed until the power is newly turned on.

Temperature setting procedure

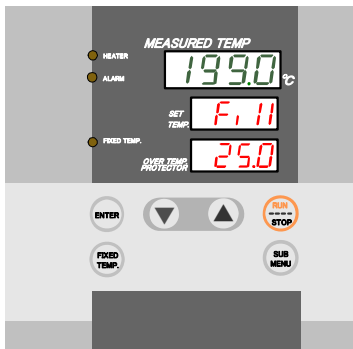

1. Turn on the power (turn on the breaker in front)

- The default value is displayed for about four seconds after turning on the power. The screen then displays the initial setting. The current temperature in bath, operation mode character and setting temperature of overheating prevention device are displayed on respective screens.

2. Set the temperature for overheating prevention

- Press the SUB MENU key.
- Press the "▼▲" several times to select the setting character of overheating prevention temperature "OH".
- Press the ENTER key. The current setting temperature is displayed with blinking on the setting temperature screen.

Note: To prevent improper operation, set the value 10°C or more over the setting temperature of controller.

- Select the value using the "▼▲" and then press the ENTER key. This completes the setting.

Notes:



- Improper setting of temperature may cause inoperative of unit, malfunction of device, e.g. it is activated during increasing in temperature in bath, or unexpected accidents such as fire disaster. To prevent such matters, set a proper value.
At the time of shipment, the temperature is set at 210°C with BOA200, and 280°C with BOA310. Do not set higher than this.
- The purpose of overheating prevention device is to protect the unit from overheating. It does not intend to protect the samples, or to protect them from the accident caused by the use of explosive or inflammability.

Overheat Prevention, Emergency Stop Switch, Recovery from Electric Outage

Function of Overheat Prevention Device

- BOA200 is equipped with independent fluid pressure-type over heating prevention device which fixes the operation temperature at 230°C. In case that the temperature of inner bath should go up by some controller errors, when it goes up to about 230°C, the earth leakage breaker will start operating and stop the power supply to the unit (manual recovery).
- BOA310 is equipped with independent fluid pressure-type over heating prevention device which fixes the operation temperature at 300°C. In case that the temperature of inner bath should go up by some controller errors, when it goes up to about 300°C, the earth leakage breaker will start operating and stop the power supply to the unit (manual recovery).
- With these functions, triple overheating prevention function is secured.



- When the independent overheating prevention device starts operating, there might be an error in the circuit. Remove the power code immediately, and contact the nearest supplier or our service office.

Function of Emergency Stop Switch

- This unit is equipped with emergency stop switch as standard in case of a fire etc. When the emergency stop switch is pressed, earth leakage breaker will start, and stop the power supply to the unit (manual recovery).



- Do not use the emergency stop switch for normal operation.

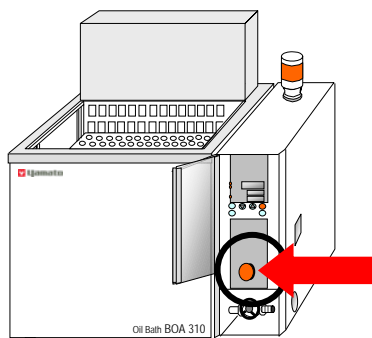

In emergency, press the emergency stop switch hard.
To cancel it, turn the knob to the right and turn on the power switch again.

In Case of Electric Outage

- In case of electric outage, this unit stops the operation and keeps stand-by position for safety.

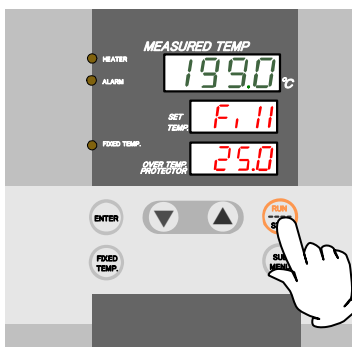

To restart operation, press RUN/STOP key for a second.
It will start operating.

Calibration Offset Function

Calibration offset function is a function which adjusts and agrees the difference of inner bath temperature and setting temperature in case that the inner bath temperature measured by standard thermometer or temperature recorder, and the temperature which is set by controller (Displayed temperature on controller) is different. When the inner bath temperature is higher than setting temperature, the difference is to be input at plus side. When the inner bath temperature is lower than setting temperature, the difference is to be input at minus side. At the time of shipment, the value is set at ± 0 .

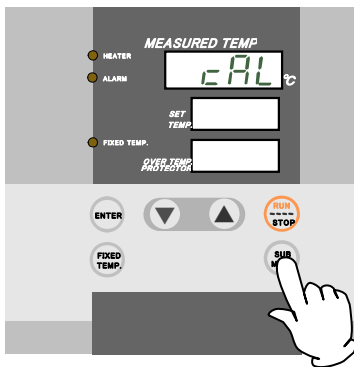
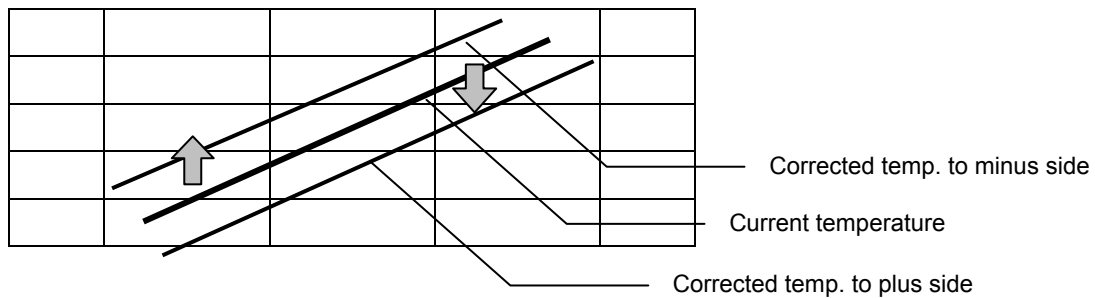

- ① Start operation with the target setting temperature. Check the temperature in bath with a thermograph after it is stabilized.
 - ② Check the difference between the setting temperature and that in bath.
 - ③ Press the SUB MENU key. Select the character "cAL", which indicates the calibration offset, using the " \blacktriangle \blacktriangledown ", and then press the ENTER key.
 - ④ Input the difference using the " \blacktriangle \blacktriangledown " and then press the ENTER key. This completes the setting.
- ❖ The setting range of offset correction temperature is $+99^{\circ}\text{C}$ to plus side and -99°C to minus side respectively.
- When it is set to the minus side, the temperature on the measurement temperature display screen falls by the setting temperature, while the temperature on bath rises.
- When it is set to the minus side, the temperature on the measurement temperature display screen rises by the setting temperature, while the temperature on bath falls.

Lock Function

This function locks the operation status previously set. The function can be set or cancelled by the SUB MENU key.

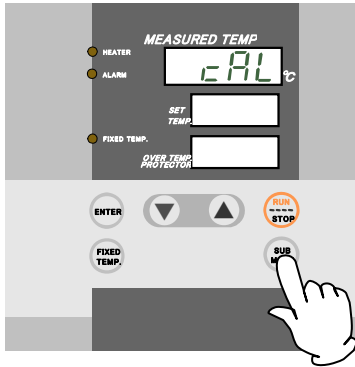

- ① Press the SUB MENU key. Select the character "Lock", which indicates the lock of setting value, using the "▲▼", and then press the ENTER key.
 - ② The setting temperature screen displays "oFF". The setting value is locked when it is turned to "o n" using the "▲".
 - ③ Press the SUB MENU key again to cancel the lock. Select the character "Lock", which indicates the lock of setting value, using the "▲▼", and then press the ENTER key. Select "oFF" with the "▼" and then press the ENTER key to cancel the function.
- ❖ All keys other than the RUN/STOP and SUB MENU keys are lock when the lock function is on.

Attached Function

This unit is equipped with the following attached function.

Terminal position

Each terminal of attached function is built in the back of the controlling part of the device.

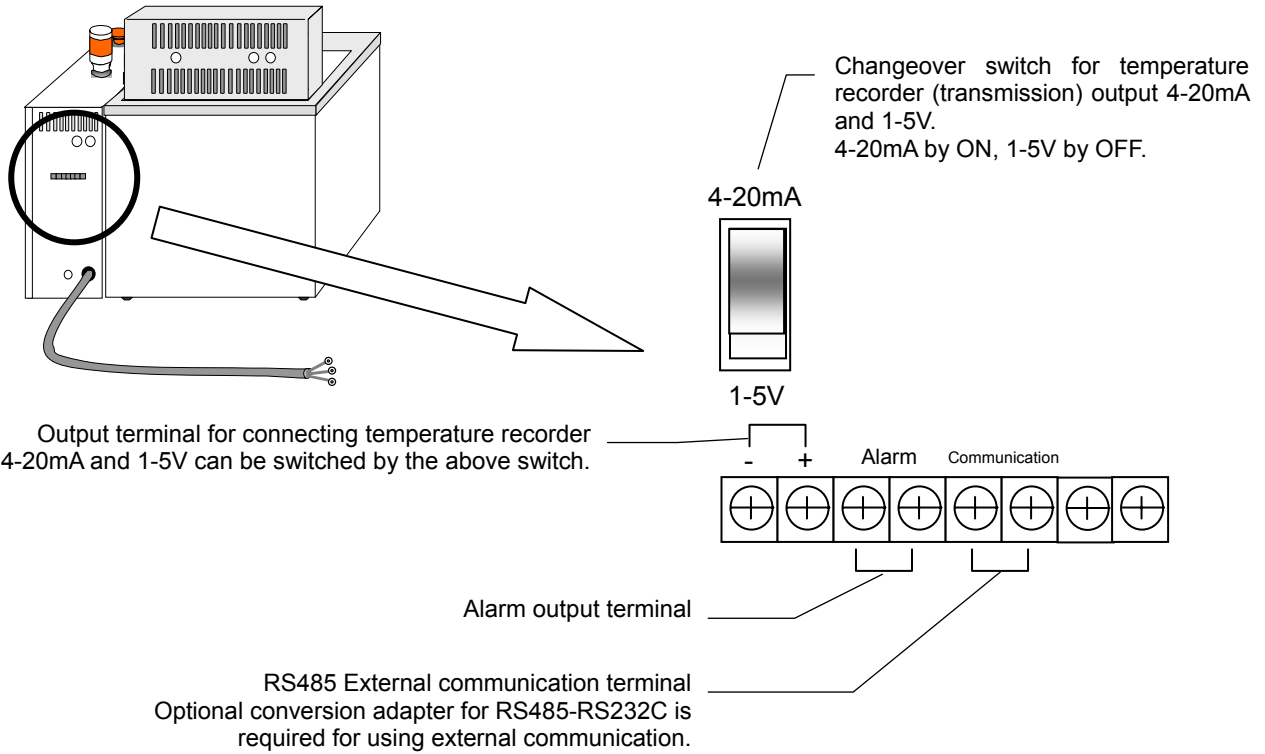

<p>1. External alarm output terminal</p> <p>Terminal for Alarm output</p>	<p>Alarm output is a function that alarm output will be ON when a failure occurs. The failure type that executes the alarm output is as follows.</p>	
	Er 01	Temperature sensor failure
	Er 02	SSR short circuit
	Er 03	Heater disconnection
	Er 15	Memory error
	Er 17	Internal communication error Failure in temperature input circuit
	Er 19	Overheating prevention failure
	Er 20	Abnormal fluid level

Attached Function

2. Temperature record output terminal (4-20mA):

Executes transmission output of the measured temperature as 4-20mA. Output temperature range

Temperature record output terminal (1-5V):

Converts the current, which was transmitted at 4-20mA, to voltage output 1-5V with fixed resistance, then output the measured temperature of controller.



- To monitor, or record the inner bath temperature directly without controller, do not use recorder output terminal. Connect the recorder directly to other sensor to measure the temperature.
- Before connecting, confirm that the breaker is turned off.
- For connecting to recorder output terminal, use recorder whose input impedance is below 600 Ω.
- Connect firmly with the screw of terminal stand.
- Use shield line as connecting cable for noise prevention.

Temperature output (analog output)

It outputs DC current or DC voltage depending on the measured temperature.

- Output temperature range:
0.0 to 205.0°C / BOA200, 0.0 to 275.0°C / BOA310
- Output current:: 4 to 20mA DC (Load: 600Ω or bellow)
- Output voltage: 1 to 5 DC
- Resolution: ±1.5°C
- Connection: M4 screw terminal block

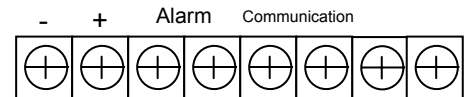

Output terminal for temperature recorder connection. 4-20mA and 1-5V can be switched.

Temperature output

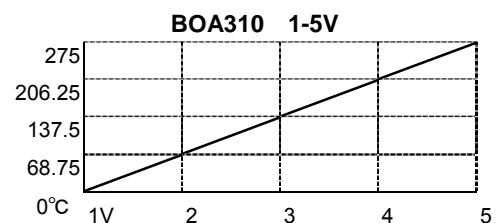
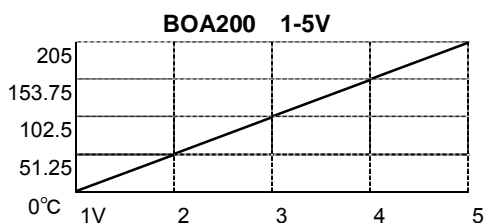
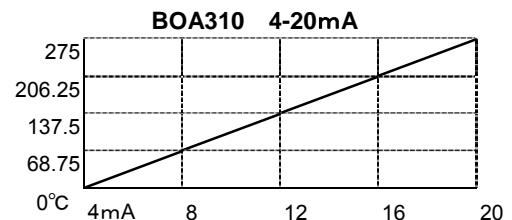
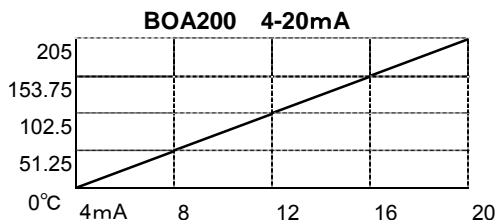

Attached Function

3. RS485 external communication terminal

Optional conversion adapter for RS485-RS232C is required for using external communication.

Communication parameter of Controller is set as follows. Contact us when the parameter change is required.

No.	Parameter name	Value at the time of shipment
1	BCC check setting	Yes
2	Data length setting	8 bit
3	Parity setting	No
4	Stop bit setting	2
5	Communication speed setting	4800BPS
6	Communication address setting	1 station
7	Response delay time setting	0mSEC
8	Communication mode switch setting	RW

Refer to the attached communication functional instructions manual for communication command etc. The sample program is on our website.

<http://www.yamato-net.co.jp/support/program/index.htm>

WARNING!

Substances that can not be used

-  Never use explosive substances, flammable substances and substances that include explosive or flammable ingredients in this unit. Explosion or fire may occur. (Refer to page 36 "List of Dangerous Substances".)

Do not perform unattended operation

-  To prevent fire, do not perform unattended operation while using oil. Greasy fumes may catch fire.

Install exhaust (ventilator), fire extinguisher

-  There is danger of a fire outbreak. Be sure to install an exhaust, a ventilator, and a fire extinguisher. When using silicone oil at above 150°C, it will generate harmful gas etc. Be sure to install an exhaust, a ventilator, and a fire extinguisher before operating.

If a problem occurs

-  If smoke or strange odor should come out of this unit for some reason, turn off the power switch right away, and then turn off the circuit breaker and the main power. Immediately contact a service technician for inspection. If this procedure is not followed, fire or electrical shock may result. Never perform repair work yourself, since it is dangerous and not recommended.

CAUTION!

Do not step on this unit

-  Do not step on this unit. It will cause injury if this unit fall down or break.

Do not place or drop anything on the unit

-  Do not place or drop anything on the unit. Since the unit contains precision components, it may malfunction due to vibration, impact, etc.

During a thunder storm

-  During a thunderstorm, turn off the power switch immediately, then turn off the circuit breaker and the main power. If this procedure is not followed, fire or electrical shock may be caused.

Countermeasure for stop operation during night or long-term stop

-  In case of stopping operation during night or long-term, toggle the breaker and power switch to "OFF".

Oil to use

-  Do not use any fluid other than the specified silicone oil. (Refer to P. 9)
Use the specified silicone oil, do regular oil change, and clean the device. Especially, the impurities adhering to heater proceed with the degradation of the heater remarkably. Clean the heater regularly. For the use as a water tank, use ion exchange water or distilled water to prevent accumulation of scale. Do not use tap water or well water since it will not only soils the bath but also reduces the heater efficiency and durability.

Recovery from electric outage

-  After the electric outage is recovered, this unit still keeps the operation stopped for safety. To start operation, press RUN/STOP key again.

Daily Inspection and Maintenance

For the safety use of this unit, please perform the daily inspection and maintenance without fail.

WARNING!

- Disconnect the power cable from the power source when doing an inspection or maintenance unless needed.
- When oil is applied to operation panel etc., wipe off the oil well. It may cause an earth leakage or an electric shock.
- Perform the daily inspection and maintenance after returning the temperature of this unit to the normal one. (Confirm that the water or oil in the bath are below 45°C.)
- Do not disassemble this unit.

CAUTION!

- Wipe off the dirt on the coating with soft cloth which is soaked with neutral detergent and extracted well. Do not wipe with benzene, thinner, cleanser, etc., or do not rub with scrub brush. It may cause modification, deterioration, and discoloration.
- Wipe off the dirt of inner bath with dry cloth. Be careful not to give cracks to the heater.

Monthly maintenance

- Check the earth leakage breaker function.
 1. Connect the power cord.
 2. Turn the breaker on.
 3. Push the red test switch by a ballpoint pen etc.
 4. If there is no problem, the earth leakage breaker will be turned off.

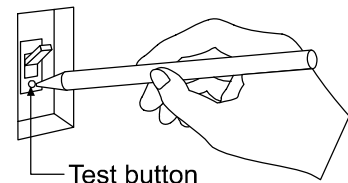

Maintaining the bath

- In case of operation using water:
If operation is continued, it will proceed with adhesion of scale. When the bath becomes dirty with scale, wash the bath well. Ion exchange water or distilled water is recommended.
- In case of operation using silicone oil:
It will be deteriorated depending on the operation temperature and operation time. Replace periodically. (Refer to P.9)

For any questions, contact the dealer who you purchased this unit from, or the nearest sales division in our company.

When not using this unit for long term / When disposing

CAUTION!

When not using this unit for long term...

- Turn off the power and disconnect the power cord.
- Extract oil/water of the bath, and wipe it off completely.

WARNING!

When disposing...

- Wipe off oil completely before disposing.
- Keep out of reach of children.

Environmental protection should be considered

We request you to disassemble this unit as possible and recycle the reusable parts considering to the environmental protection. The feature components of this unit and materials used are listed below.

Component Name	Material
Exterior Parts	
Outer covering	Iron and steel plate baked with melamine resin coating
Inner bath	Stainless steel SUS304
Heat insulation material	Plaster board, glass wool
Plates	PET resin film
Rubber feet	Chloroprene rubber
Electrical Parts	
Switches, Relay	Composite of resin, copper and other
Circuit boards	Composite of glass fiber and other
Pipe heater	Composite of stainless steel, SUS316L, nichrome and other
Power cord	Synthetic rubber coated wiring materials, copper and nickel
Accessory	
Shelf	Stainless steel SUS304

Safety Device and Error Code

The error display on the controller is as follows. If an error occurs, a heater output will be suspended and abnormalities will be told with the display in error mode, lighting of ALARM lamp, and buzzer sound. Record the error code, intercept the power supply, and make a service call.

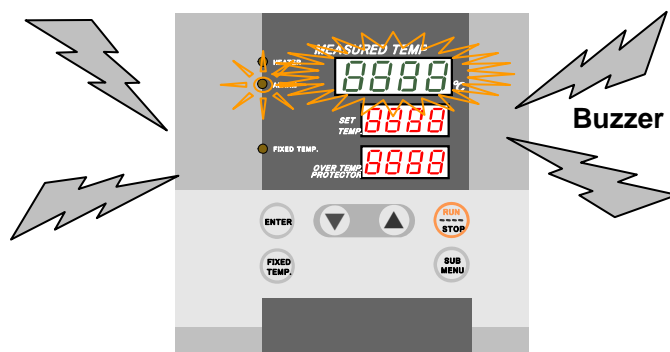

Safety Device	Error Code	Cause/Solution
Temperature sensor failure	Er 01	<ul style="list-style-type: none"> ❖ Temperature sensor disconnection and out of joint. ❖ The sensor needs to be checked or replaced. ❖ It is canceled by power reset.
SSR short circuit	Er 02	<ul style="list-style-type: none"> ❖ SSR failure. ❖ SSR needs to be replaced. ❖ It is canceled by power reset.
Heater disconnection	Er 03	<ul style="list-style-type: none"> ❖ Heater is disconnected, or failure of heater circuit. ❖ It is canceled by power reset.
Memory error	Er 15	<ul style="list-style-type: none"> ❖ Memorized setting value is abnormal. ❖ Substrate needs to be replaced.
Internal communication error Failure in temperature input circuit	Er 17	<ul style="list-style-type: none"> ❖ Circuit in temperature adjuster is abnormal. ❖ Substrate needs to be replaced.
Overheating prevention failure	Er 19	<ul style="list-style-type: none"> ❖ Overheating prevention device in temperature controller is started. ❖ It is canceled by power reset. ❖ Refer to P.14 "Operation Mode and Function List".
Abnormal fluid level	Er 20	<ul style="list-style-type: none"> ❖ Abnormal rise/decline of inner bath fluid level. ❖ Adjust the inner bath fluid level. ❖ Refer to P. 9 "Preparation for Operation".
Independent overheating prevention device	Nondisplay	<ul style="list-style-type: none"> ❖ Abnormality in temperature adjustment circuit. ❖ It needs service call.
Emergency stop switch	Nondisplay	<ul style="list-style-type: none"> ❖ Manual operation in emergency ❖ Turn the emergency stop switch to the right, and then turn on the power switch again.

Trouble Shooting

Phenomenon	Check point
The unit does not start to operate although the leakage breaker is turned on.	<ul style="list-style-type: none">• Check if the power cable is securely connected to the power supply.• Check if the power fails.
Breaker is shut off.	<ul style="list-style-type: none">• Check if the emergency stop switch is turned on.• Check if the independent overheating prevention device is operating.
Alarm lamp lights on.	<ul style="list-style-type: none">• Check if the overheating prevention setting temperature of the controller is lower than the inner bath temperature.• Check if the fluid level in the bath is too low or too high.
The temperature does not drop.	<ul style="list-style-type: none">• Check if the set temperature is higher than the inside temperature of the bath.
Measured temperature is abnormally high or low.	<ul style="list-style-type: none">• Check if abnormal value is inputted to calibration offset temperature. (Refer to P.21)

In the case if the error other than listed above occurred, turn off the power switch and primary power source immediately. Contact the shop of your purchase or nearest Yamato Scientific Service Office.

In Case of Request for Repair

If the failure occurs, stop the operation, turn OFF the power switch, and unplug the power plug. Please contact the sales agency that this unit was purchased, or the Yamato Scientific's sales office.

< Check following items before contact >

- ◆ Model Name of Product
 - ◆ Production Number
 - ◆ Purchase Date
 - ◆ About Trouble (in detail as possible)
- } See the production plate attached to this unit.

Minimum Retention Period of Performance Parts for Repair

The minimum retention period of performance parts for repair of this unit is 7 years after discontinuance of this unit.

The "performance part for repair" is the part that is required to maintain this unit.

Product Name	Constant temperature oil bath	
Model	BOA200	BOA310
Bath capacity	Approx. 37L (In case that oil level is lower than 50mm from the top edge of inner bath.)	
Effective bath capacity	Approx. 31.9L (When the lowest shelf is installed)	
Temperature control range	Room temp.+10°C to 200°C	Room temp.+10°C to 270°C
Temperature control accuracy*	±0.1°C (200°C silicon oil)	
Temperature distribution accuracy*	±0.2°C (200°C silicon oil)	±0.3°C (200°C silicon oil)
Temperature control system	PID controller, platinum sensor	
Temperature setting method	Digital setting by ▲▼ keys	
Minimum unit of setting temperature	0.1°C	
Temperature display method	Digital 7 segments LED for the measured temperature, setting temperature and overheating prevention screen	
Heater	SUS316 pipe heater 2kW	SUS316 pipe heater 4.5kW
Stirrer	Vertical type propeller stirring 25W Induction motor	
Safety functions	Earth leakage breaker with test-lead, Self-diagnostic functions, Sensor failure detection, Heater failure detection, Key lock function, Overheating prevention device, Automatic overheating prevention (auto-recovery at setting temperature + 6°C), Independent overheating prevention device	
Other functions	Fixed temperature operation, Alarm output terminal, Drain cock, Operation indicator lamp, Output terminal for temperature record (4-20mA/1-5V switch attached)	
External dimensions	Approx. 531W × 520D × 578H mm (height of bath: 397mm)	
Bath dimensions	Approx. 440W × 460D × 320H mm	
Effective internal dimensions	Approx. 293W × 340D × 270H mm (from the top edge of inner bath to the level of the lowest shelf)	
Weight	Approx. 37kg	
Power supply	100V AC 21A	200V AC (single phase) 23A
Accessories	Shelf, Cover, Instruction manual	

* The temperature control accuracy and temperature distribution accuracy of this unit are the values which are measured by using TOSHIBA Silicone TSF 485-50. The temperature control accuracy and temperature distribution accuracy change depending on the silicone oil type and the case of water use.

Optional accessory

Name	Description
External communication adapter	RS485-RS232C conversion

BOA200

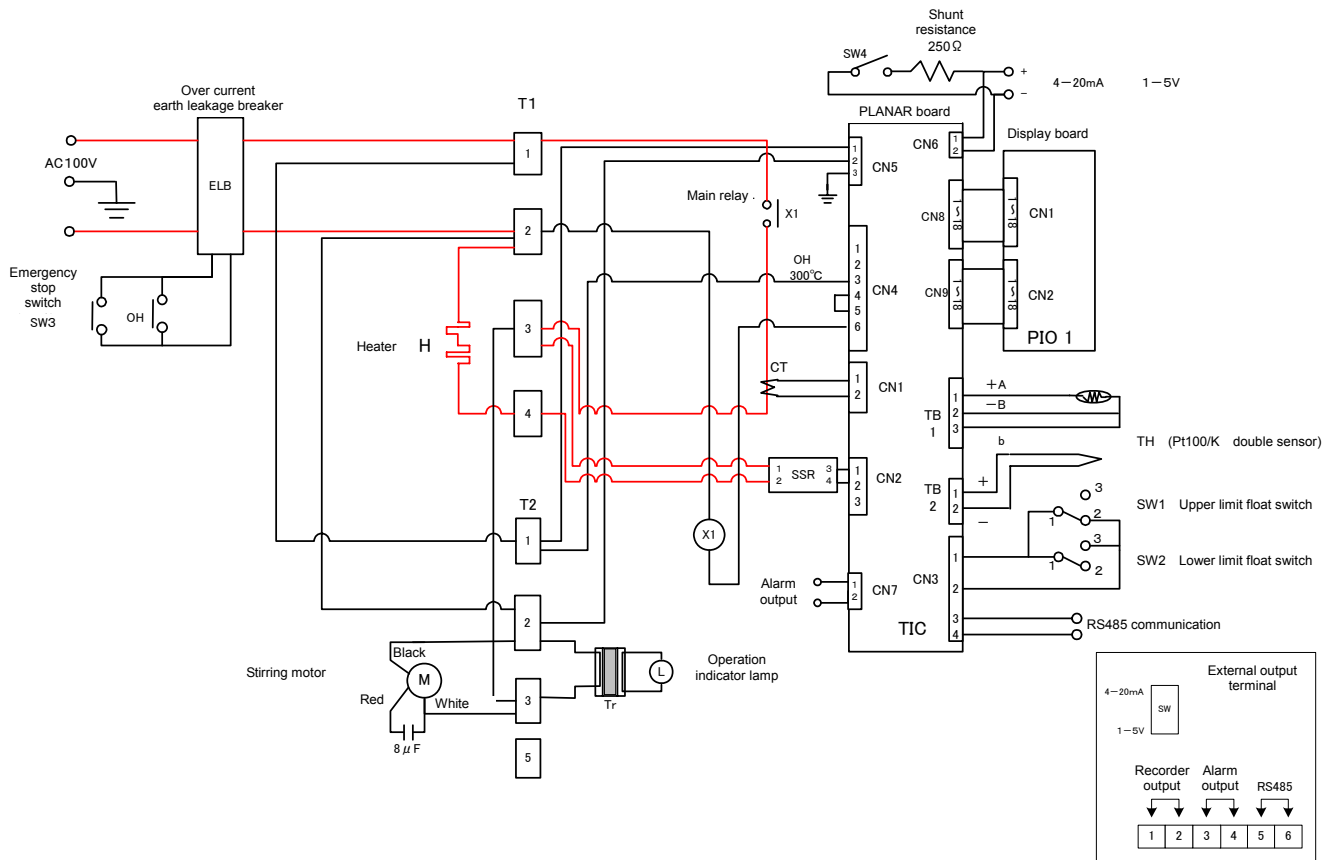

Symbol	Part name	Symbol	Part name
ELB	Over current earth leakage breaker	SW4	Transmission output changeover switch
T1, 2	Terminal block	250 Ω	Voltage output resistance
TIC	PLANAR board	OH	Independent overheating prevention device
PIO1	Display board	CT	Current transformer
X1	Main relay	SSR	Static relay
L	Operation indicator lamp	H	Heater
SW1	Upper limit float switch	TH	Double sensor
SW2	Lower limit float switch	M	Stiring motor
SW3	Emergency stop switch	Tr	Transformer for operation indicator lamp

BOA310

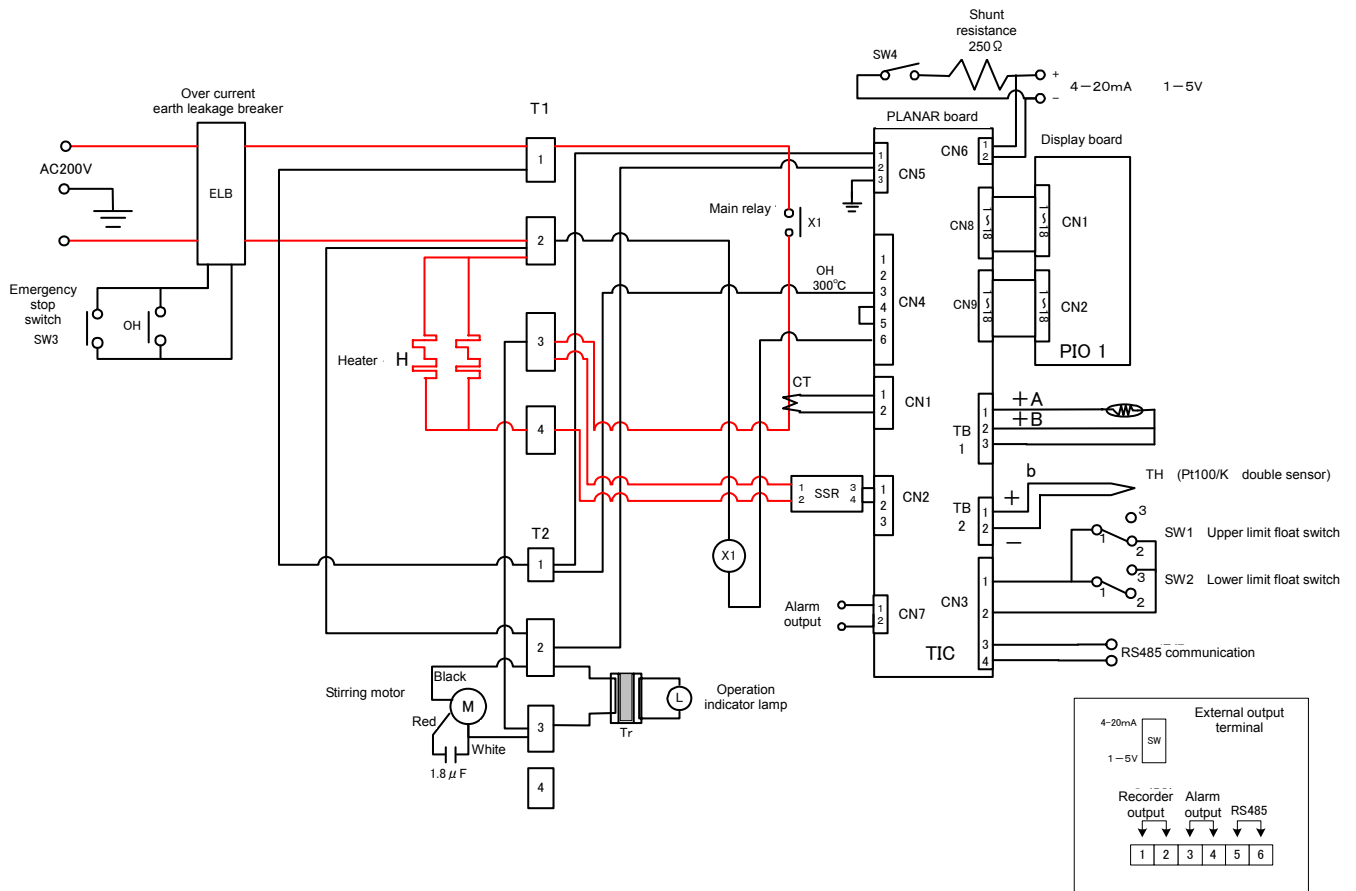

Symbol	Part name	Symbol	Part name
ELB	Over current earth leakage breaker	SW4	Transmission output changeover switch
T1, 2	Terminal block	250 Ω	Voltage output resistance
TIC	PLANAR board	OH	Independent overheating prevention device
PIO1	Display board	CT	Current transformer
X1	Main relay	SSR	Static relay
L	Operation indicator lamp	H	Heater
SW1	Upper limit float switch	TH	Double sensor
SW2	Lower limit float switch	M	Stiring motor
SW3	Emergency stop switch	Tr	Transformer for operation indicator lamp

Replacement Parts Table

Common parts

Part Name	Code No.	Specification	Manufacturer
Earth leakage breaker	LT00034880	BJS3032NTBL	Panasonic
VS3P control board	1-02-000-0054	VS3P	Yamato Scientific
VS3P display board	1-02-000-0051	VS3	Yamato Scientific
Double sensor	LT00004763	250L Pt100-K	Yamato Scientific
Static relay	2-16-000-0036	TRS1245	Toho Denshi
Current sensor	2-17-001-0005	CTL-6-S-H	URD
Terminal block	S15	MO11-0FX4P	Toyo Giken
Terminal block	LT00004736	ATK-20-4P	Toyo Giken
Emergency stop switch	LT00005037	AR30V2R-11R	Fuji Denki
Independent overheating prevention device	LT00005293	EGO1316202 320°C	EGO
Micro switch	2-02-001-0003	AHR540161	Matsushita
Operation indicator lamp	LT00005273	PRE ϕ 45	Menix
Transmission output changeover switch	LT00005278	EL115A 125V 15A	Fujisoku

For BOA200

Part Name	Code No.	Specification	Manufacturer
Pipe heater	LT00004803	AC100V 2Kw	Yamato Scientific
Stirring motor	LT00006362	4IK25A-AWJ AC100V 25w	Oriental
Transformer for operation indicator lamp	LT00005274	AC115V-DC24V	Menix
Main relay	LT00005140	AHE1274 100V 30A	Matsushita

For BOA310

Part Name	Code No.	Specification	Manufacturer
Pipe heater	LT00004804	AC200V 2.25Kw	Yamato Scientific
Stirring motor	LT00006363	4IK25A-CWJ AC200V 25W	Oriental
Transformer for operation indicator lamp	LT00005332	AC220V-DC24V	Menix
Main relay	2-05-000-0059	AHE1275 200V 30A	Matsushita

List of Dangerous Substances



Never use explosive substances, flammable substances and substances that include explosive or flammable ingredients in this unit.

EXPLOSIVE

EXPLOSIVE:	Ethylene glycol dinitrate (nitro glycol), Glycerin trinitrate (nitroglycerine), Cellulose nitrate (nitrocellulose), and other explosive nitrate esters
	Trinitrobenzene, Trinitrotoluene, Trinitrophenol (picric acid), and other explosive nitro compounds
	Acetyl hidroperoxide (peracetic acid), Methyl ethyl ketone peroxide, Benzyl peroxide, and other organic peroxides

FLAMMABLE

IGNITING:	Lithium (metal), Potassium (metal), Sodium (metal), Yellow phosphorus, Phosphorus sulfide, Red phosphorus, Celluloid compounds, Calcium carbide, Lime phosphate, Magnesium (powder), Aluminum (powder), Powder of metals other than magnesium and aluminum, Sodium hydrosulfite
OXIDIZING:	Potassium chlorate, Sodium chlorate, Ammonium chlorate, and other chlorate
	Potassium perchlorate, Sodium perchlorate, Ammonium perchlorate, and other perchlorate
	Potassium peroxide, Sodium peroxide, Barium peroxide, and other inorganic peroxide
	Potassium nitrate, Sodium nitrate, Ammonium nitrate, and other nitrate
	Sodium chlorite and other chlorites
	Calcium hypochlorite and other hypochlorites
INFLAMMABLE LIQUID:	Ethyl ether, Gasoline, Acetaldehyde, Propylene chloride, Carbon disulfide, and other flammable substances having a flash point of lower than -30°C
	Normal hexane, ethylene oxide, acetone, benzene, methyl ethyl ketone, and other flammable substances having a flash point of -30°C or higher but lower than 0°C
	Methanol, Ethanol, Xylene, Pentyl acetate (amyl acetate), and other flammable substances having a flash point of 0°C or higher but lower than 30°C
	Kerosene, Light oil (gas oil), Oil of turpentine, Isopentyl alcohol (isoamyl alcohol), Acetic acid, and other flammable substances having a flash point of 30°C or higher but lower than 65°C
FLAMMABLE GAS:	Hydrogen, Acetylene, Ethylene, Methane, Propane, Butane, and other flammable substances which assume a gaseous state at 15°C and 1 atm

(Source: Appendix Table 1 of Article 6 of the Industrial Safety and Health Order in Japan)

* Install the unit according the procedure described below (check options and special specifications separately).

Model	Serial number	Date	Person in charge of installation (company name)	Person in charge of installation	Judgment

No.	Item	Method	Reference operation manual	Judgment
Specifications				
1	Accessories	Check the quantities of accessories with the quantities shown in the Accessory column.	Specification	P.32
2	Installation	<ul style="list-style-type: none"> Visually check the surrounding area. Caution: Be careful about the circumstance, exhaust, fire extinguisher, oil type, oil amount to supply.	Before Using This Unit "2. Choose a proper place for installation"	P.5
Operation				
1	Power voltage	<ul style="list-style-type: none"> Using a tester, measure the voltage of the voltage used by the customer (distribution board, outlet, etc.). Measure the voltage during operation (the voltage must be within the standard). Caution: When a unit is to be connected to the plug or breaker, use one that conforms to the standard.	Before Using This Unit "1. Always ground this unit"	P.5
			Before Using This Unit "7. Choose a correct power distribution board or receptacle"	P.7
			Specification	P.32
2	Start of operation	<ul style="list-style-type: none"> Start operation. Supply silicone oil, set the temperature at 100°C, and confirm the stability.	Before Using This Unit	P.5
			Operation Method	P.14
			Handling Precautions	P.26
3	Stop of operation	<ul style="list-style-type: none"> Stop operation. Inform the customer that oil temperature is high, and complete the installation.	Operation Method	P.14
			Handling Precautions	P.26
Description				
1	Description of operation	Explain the operation of each unit to the customer according to this Operation Manual.	All	
2	Error code	Explain error codes and the procedure for resetting them to the customer according to this Operation Manual.	In the Event of Failure...	P.29
3	Maintenance inspection	Explain the operation of each unit to the customer according to this Operation Manual.	Maintenance Method	P.27
4	Completion of installation Information to be entered	<ul style="list-style-type: none"> Enter the date of installation and the name of the person in charge of installation on the face plate on the unit. Enter necessary information on the guarantee, and pass it to the customer. Explain the after-sale service route to the customer. 	After Service and Warranty	P.31

Responsibility

Please follow the instructions in this document when using this unit. Yamato Scientific has no responsibility for the accidents or breakdown of device if it is used with a failure to comply. Never conduct what this document forbids. Unexpected accidents or breakdown may result in.

Note

- ◆ The contents of this document may be changed in future without notice.
- ◆ Any books with missing pages or disorderly binding may be replaced.

Instruction Manual for
Constant Temperature Oil Bath
Model BOA200/310

First Edition Jul. 13, 2006
Revised Feb. 20, 2012

Yamato Scientific Co., Ltd.

2-1-6 Nihonbashi Honcho, Chuo-ku,
Tokyo, 103-8432, Japan

<http://www.yamato-net.co.jp>