

Yamato

Water Bath

BM401

Oil Bath

BO601

Instruction Manual

- First Edition -

- Thank you for choosing BM/BO Series Baths from Yamato Scientific Co., Ltd.
- For proper equipment operation, please read this instruction manual thoroughly before use. Always keep equipment documentation safe and close at hand for convenient future reference.







WARNING:

Read instruction manual warnings and cautions carefully and completely before proceeding.

Yamato Scientific America Inc.

Contents

1. Safety Precautions	1
Explanation of Safety Symbols	1
Symbol Glossary	2
1. Safety Precautions	3
 WARNING	3
 CAUTION!	4
2. Before operating the Equipment	5
Precautions when installing the Equipment	5
Prior Confirmation	8
Installation for rotary evaporator	11
3. COMPONENT NAMES & FUNCTIONS	12
Unit Overview	12
Unit Overview	13
Control Panel	14
4. OPERATION PROCEDURES	15
Operation Modes & Functions	15
Mode & Function Flow	17
Constant (Fixed) Temperature Mode	18
Auto Stop Mode	21
Auto Start Mode	24
Overheat Prevention Settings	27
Keypad Lock Function	28
Calibration Offset Function	29
Power Failure Recovery	31
5. HANDLING PRECAUTIONS	32
 WARNING!	32
 CAUTION !	33
6. MAINTENANCE PROCEDURE	34
Inspection and Maintenance	34
Inspect monthly	34
7. EXTENDED STORAGE & DISPOSAL	35
Extended Storage / Unit Disposal	35
Disposal Considerations	35
8. TROUBLESHOOTING	36
Error Code Guide	36
Troubleshooting Guide	37
9. SERVICE & REPAIR	38
When requesting a repair	38

10. SPECIFICATIONS	39
11. WIRING DIAGRAM	41
Wiring Diagram Glossary	41
12. LIST OF HAZARDOUS SUBSTANCES	42
13. SETUP CHECKLIST	43

1. Safety Precautions

Explanation of Safety Symbols

A Word Regarding Symbols

Various symbols are provided throughout this text and on equipment to ensure safe operation. Failure to comprehend the operational hazards and risks associated with these symbols may lead to adverse results as explained below. Become thoroughly familiar with all symbols and their meanings by carefully reading the following text regarding symbols before proceeding.

 **Warning** Signifies a situation which may result in serious injury or death (Note 1)

 **Caution** Signifies a situation which may result in minor injury (Note 2) and/or property damage (Note 3)

(Note 1) Serious injury is defined as bodily wounds, electrocution, bone breaks/fractures or poisoning, which may cause debilitation requiring extended hospitalization and/or outpatient treatment.

(Note 2) Minor injury is defined as bodily wounds or electrocution, which will not require extended hospitalization or outpatient treatment.

(Note 3) Property damage is defined as damage to facilities, equipment, buildings or other property. (Note 1) Serious injury is defined as bodily wounds,

Symbol Meanings



Signifies warning or caution.
Specific explanation will follow symbol.



Signifies restriction.
Specific restrictions will follow symbol.



Signifies an action or actions which operator must undertake.
Specific instructions will follow symbol.

1. Safety Precautions

Symbol Glossary

Warning



General Warning

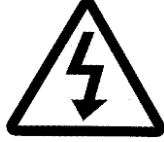

Danger!: High Voltage



Danger!: Extremely Hot



Danger!: Moving Parts



Danger!: Blast Hazard

Caution



General Caution



Caution: Electrical Shock Hazard!



Caution: Burn Hazard!



Caution: Do Not Heat Without Water!



Caution: May Leak Water!



Caution: Water Only



Caution: Toxic Chemicals

Restriction



General Restriction



No Open Flame



Do Not Disassemble



Do Not Touch

Action



General Action Required

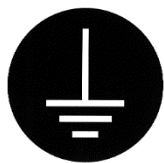

Connect Ground Wire



Level Installation Required



Disconnect Power



Inspect Regularly

1. Safety Precautions



WARNING



Never operate equipment near combustible gases/fumes.

Do not install or operate BM/BO series units near flammable or explosive gases/fumes. Unit is NOT fire or blast resistant. Negligent use could cause a fire/explosion. See "List of Hazardous Substances".



Always ground equipment.

Always ground this unit properly to avoid electric shock.



Turn the power of the controller and the ELB off immediately when you notice any abnormality.

Turn the power of the controller and the ELB off immediately and unplug Power Cord from outlet or disconnect the breaker or switch board of facilities, If smoke or strange smell is generated from this Equipment by chance. It may cause fire or electrical shock.



DO NOT operate with bundled or tangled power cable.

Operating unit with the power cable bundled or otherwise tangled, may cause power cable to overheat and/or catch fire.



DO NOT damage power cable.

Damaging the power cable by forcibly bending, pulling or twisting may cause fire or electric shock to the operator.



DO NOT process explosive or flammable substances.

Never place or process explosive/flammable substances, nor substances that contain explosive/flammable substances in this unit. An explosion or fire may occur. See "List of Hazardous Substances".



● Do not apply other than water to Water Bath Model BM401. Water as the heat medium only must be used to this equipment. It may cause fire, if oil as the heat medium will be applied.

● Apply the suitable heat medium such as Shin-Etsu Chemical Co., Ltd.'s silicon oil #KF-96-50CS or the equivalent for Oil Bath Model BO601.



Install an exhaust, a ventilator, and a fire extinguisher.

When you use for BO601

The lamp black of silicone oil generated by heating has inflammability, and may cause a fire. Also, if silicone oil is heated to high temperature, it may generate harmful gas etc. When using the equipment, be sure to install an exhaust system, ventilationsystem, and a fire extinguisher.



DO NOT heat without adding required fluid.

Running BM/BO devices without adding required fluids may result in equipment damage and/or fire.

1. Safety Precautions

WARNING!



Do not splash water around the electrical assembly and control panel.

It may cause electrical shock and fire, if the equipment is splashed by water.



DO NOT disassemble or modify equipment.

Attempting to dismantle or modify unit in any way, may cause malfunction, fire or electric shock.



Avoid touching hot surface areas.

The metal bath container and main unit interior become hot during operation and may remain hot following operation. Avoid contacting these areas with bare fingers and hands. Burns or other injury may result.

CAUTION!



Turn immediately the power of the controller and the ELB off at thundering.

Turn immediately the power of the controller and the ELB off at thundering. If not, it may cause fire or electric shock.



Power Outages

Turn off main power switch for safety. Operation is stopped when power failures occur.

- ※ The power failure recovery function will be set that the equipment state is to resume its operation or to go back to standby after the power recovery.
If this function is set at 'OFF', then the equipment will be back to the standby state.
If this function is set 'ON', then the equipment will resume its operation.
The equipment will be set at 'OFF' at the factory delivery.

2. Before operating the Equipment

Precautions when installing the Equipment

1. Choose proper place for installation



Do not install this Equipment in the place where:

- the location is rough, dirty or un-leveled.
- flammable gas, explosive gas or corrosive gas will be generated.
- ambient temperature will be more than 35°C or less than 5°C.
- ambient temperature will fluctuate.
- there is excessive humidity and dusty.
- there is constant vibration.
- power supply is instable.
- Liquid may splash
- there is direct sunlight.
- outside the building.



Install the Equipment at the place with sufficient space as specified as below.

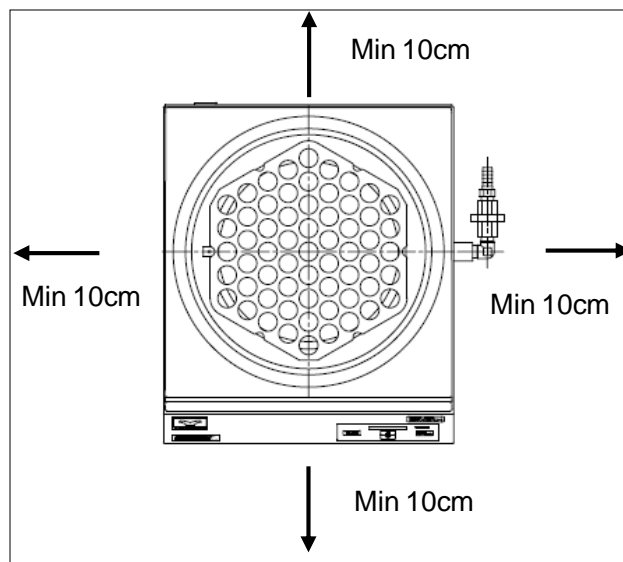

2. Install the Equipment on leveled location.



Install this Equipment on leveled floor. If it is installed on rough and/or slope floor, vibration or noise will be occurred

3. Implement safety measures when installing the unit.



May be injured by moved and/or fallen this Equipment down by earthquake and/or unexpected impact. Recommend to install this Equipment at the place away from the access door and to take other safety steps.

4. Never operate in an atmosphere where flammable or explosive gas is present.



Never operate this Equipment in an atmosphere where flammable or explosive gas is present. This Equipment is not explosion-proof. Spark may be discharged by switching Earth Leakage Breaker (ELB) "ON(|)" and "OFF(○)" and also relay during operation, and then it may cause fire or explosion. See "List of Hazardous Substances" .



2. Before operating the Equipment

Precautions when installing the Equipment

5. Must connect grounding wire properly.



- Ground wire must be connected to a proper grounding line or terminal in order to avoid electrical shock.
- Never connect ground wire to gas lines or water pipes.
- Never connect ground wire to telephone grounding lines or lightning rods. Doing so may result in fire or electric shock.
- Never insert multiple plugs into a single outlet. Doing so may result in power cable overheating, fire or drop in voltage.



Connect to grounded outlet.

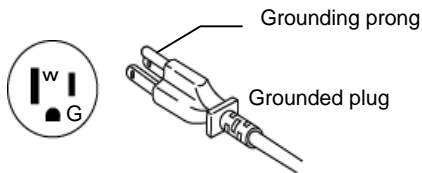

Outlet with ground receptacle

When no grounding terminal is found:

- •Grounding to Electrical Equipment Technical Standards, Section 19, class D (Grounding Resistance Max. 100Ω) is required in Japan. Contact a local dealer, electrician, or Yamato Sales office for location-specific electrical requirements.

Use grounded adapter for ungrounded outlets.

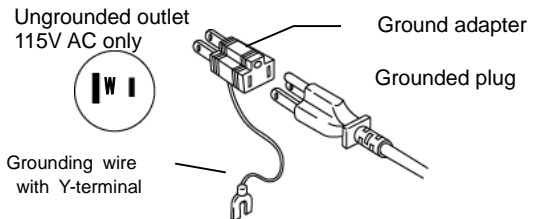

Outlet with no ground receptacle

Ground adapter

- •Insert grounded power plug into ground adapter. Connect grounding wire (green) from ground adapter to a ground terminal.

6. Handle Power Cord/Power Cable carefully.



Never operate this Equipment at bundled Power Cord/Power Cable. May heat its Cord/Cable and then cause fire, if operate at bundled it.

Do not modify, bend forcibly, twist or pull Power Cord/Power Cable. Otherwise, may cause fire and/or electrical shock.

Do not damage Power Cord/Power Cable by setting under any desk and/or chairs, or by pinching it between objects. Otherwise, may cause fire and/or electrical shock.

Do not place Power Cord/Power Cable close to kerosene heater, electric heater, or other heat-generating devices.

Insulation of Power Cord/Power Cable may burn and cause fire or electrical shock.



Turn immediately off Earth Leakage Breaker (ELB) and also disconnect Power Plug/breaker of switch board of facilities, if it is damaged such as exposure of core wire or disconnection.

May cause fire or electrical shock, if this Equipment is operated with damaged Power Cord/Power Cable.

Ask local dealer to replace Power Cord/Power Cable.

Connect Power Cord/Power Cable to appropriate receptacle or switch board of facilities.

7. Connect Power Cord/Power Cable to receptacle or switch board of facilities.



Connect Power Cord/Power Cable to suitable receptacle/switch board of facilities according to electrical requirements as follows.

Electrical requirements : AC115V 50/60Hz 11.0A

- ※Check line voltage of its receptacle/switch board of facilities and/or whether utilize the same line with other equipments or not, if this Equipment does not start up/operate even to turn Earth Leakage Breaker(ELB) On. Take correct action for the solution, such as changing its power source away from other equipment.

2. Before operating the Equipment

Precautions when installing the Equipment

8. Connecting related equipment to service outlet.



BM/BO units are equipped with a service outlet designed to power related machines, such as a rotary evaporator. Be advised that this outlet is connected directly to the main power switch, thus power to this outlet is interrupted when the main power switch is turned off. Confirm equipment power ratings before connecting.
Service outlet power capacity: 115V AC, 2A.

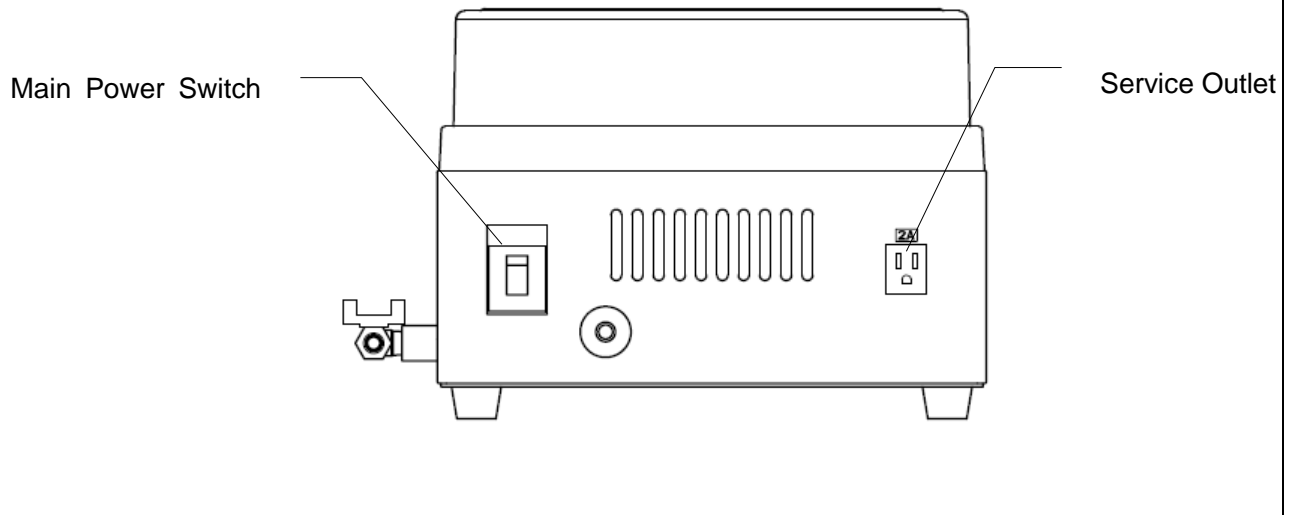

9. Install an exhaust, a ventilator, and a fire extinguisher.



When you use for BO601

The lamp black of silicone oil generated by heating has inflammability, and may cause a fire. Also, if silicone oil is heated to high temperature, it may generate harmful gas etc. When using the device, be sure to install an exhaust, a ventilator, and a fire extinguisher.

10. Do not use the unit in a place where it is exposed to a liquid



Do not operate the unit in a place where it is exposed to a liquid. If a liquid enters the unit, an accident, malfunction, electric shock or fire may result.

11. DO NOT disassemble or modify.



Attempting to disassemble or modify this unit in any way may result in malfunction, fire or electric shock.

2. PRE-OPERATION PROCEDURES

Prior Confirmation

1. BM401 water bath operation precautions:



Exercise caution in regard to the following.

- Use water for bath fluid. Using purified or distilled water is recommended to prevent mineral deposit buildup.
- Connect unit to a power outlet having sufficient capacity.
- Do not move unit while in operation.
- Avoid touching hot surface areas or bath fluid during operation.
- Do not drain unit until water temperature falls below 45°C.
- Be sure not to spill water on or around unit while adding. Electric shock or fire may result.
- Do not leave unit unattended during operation.
- Do not place or operate unit outdoors.
- Do not heat unit without water.

2. BO601 oil bath operation precautions



Exercise caution in regard to the following.

- Use ONLY silicon oil for bath fluid.
- Connect unit to a power outlet having sufficient capacity.
- Do not move unit while in operation
-
- Avoid touching hot surface areas or bath fluid during operation.
- Do not drain unit until oil temperature falls below 45°C.
- Be sure not to spill oil on or around unit while adding. Electric shock or fire may result.
- Do not leave unit unattended during operation.
- Be careful not to allow oil to overflow while heating.
- Do not place or operate unit outdoors.
- Do not heat unit without oil.

3. Fluid medium for BO601 oil bath



Maximum operating temperature for BO601 model oil baths is 180°C.

Use heat-resistant dimethyl silicon oil for open system heat transfer only, and Kinematic viscosity of 50mm²/s (cSt) or less.

Recommended:

Recommended: KF-96-50cs silicon oil by Shinetsu Science Industries Co.,

Silicon oil characteristics	Appearance	Clear
	Kinematic viscosity (@25°C)	50mm ² /s
	Specific gravity (@25°C)	0.960
	Volatility (150°C, 24h)%	Less than 0.5%
	Viscosity temperature coefficient	0.59
	Pour point (°C)	<-50°C
	Flash point (°C)	Above 310°C
	Specific heat (@25°C) (J/g·°C)	1.5J/g·°C
	Thermal conductivity (@25°C) (W/m·°C)	0.15W/m·°C
	Expansion coefficient (25~150°C)	0.00096cc/cc/°C

2. PRE-OPERATION PROCEDURES

Prior Confirmation



- ※ Silicon oil can generate formaldehyde at approximately 150°C(300°F) and above in the presence of air. Formaldehyde is a skin and respiratory sensitizer, eye and throat irritant, acute toxicant and potential cancer hazard. So, use adequate ventilation or wear protective equipment such as gloves, goggles, organic vapor respirator or protective clothing when silicon oil is heated at approximately 150°C(300°F) and above in the presence of air.
- ※ Degradation rate (change in viscosity) of silicon oil depends on the operating temperature. Please contact the local silicon oil dealer at the time of purchase.
- ※ The recommended silicon oil will be #KF-96-56cs of Shin-Etsu Chemical Co., Ltd. or equivalent specification of silicon oil. It should be noted that #KF-96 series there are several types from low to high viscosity. The low viscosity ones will limit for the high side temperature and the high viscosity ones may cause the overheating to the heater locally. It may cause fire.

4. Water/oil bath levels



- Maximum fluid bath level (water/silicon oil) when heated should be approximately 2cm or more above the top of the sensor or 3.5L or more total fluid volume. Insufficient fluid level may result in inaccurate or erratic temperature readings or inability to control temperature, which may cause overheating and fire hazards.
- Water and silicon oil levels should be approximately 4cm from the top lip of the bath with specimen flask/beakers submersed.
 - ※ **Exercise caution in the amount of silicon oil supplied to oil bath.**
Do not use more than 3.8 liters oil in reservoir.
Silicon oil has a broad thermal expansion capacity and may overflow from bath when heated, if too much oil is added.



Caution

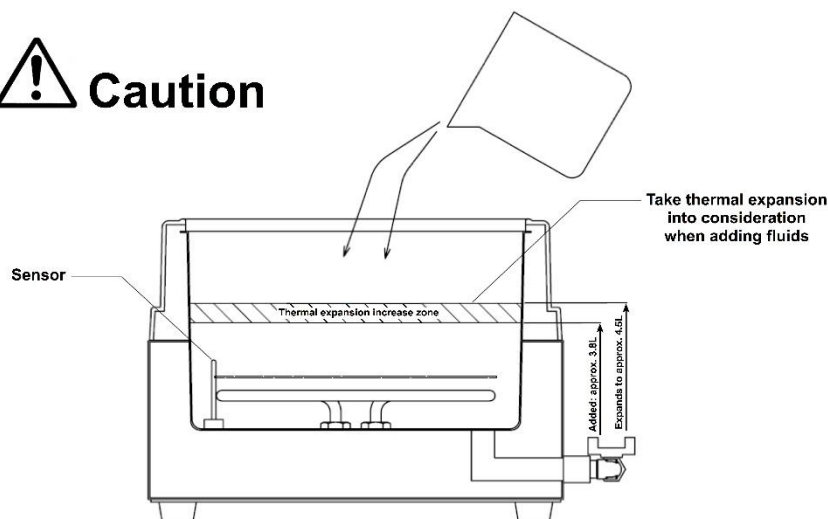

2. PRE-OPERATION PROCEDURES

Prior Confirmation

5. Heater Baffle



- When inserting the heater baffle into the reservoir, be sure that one of the 6 side notches lines up with the sensor and that the sensor does not contact the baffle.
- When using heater baffle as a platform to support beakers or other specimen containers, be sure that these do not contact the sensor. Abnormal temperature control or sensor damage may result. Always be vigilant of sensor position and do not allow objects to contact it.

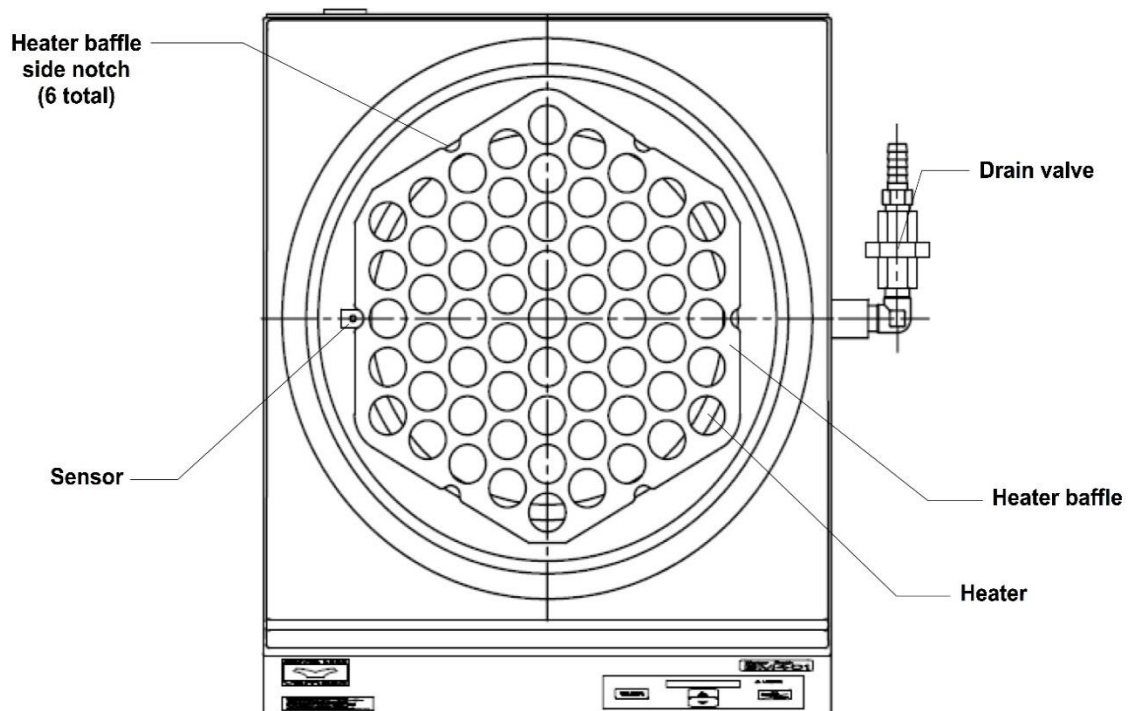

- When operating BM401 water bath without heater baffle, and processing items in beakers or other containers, be sure not to allow these to directly contact the heater.
- Never process items in beakers or other stand-alone containers in BM601 without heater baffle. Direct contact with heater may cause damage to heater, leading to serious hazards or mishaps.

2. PRE-OPERATION PROCEDURES

Installation for rotary evaporator

Shown in combination with RE200

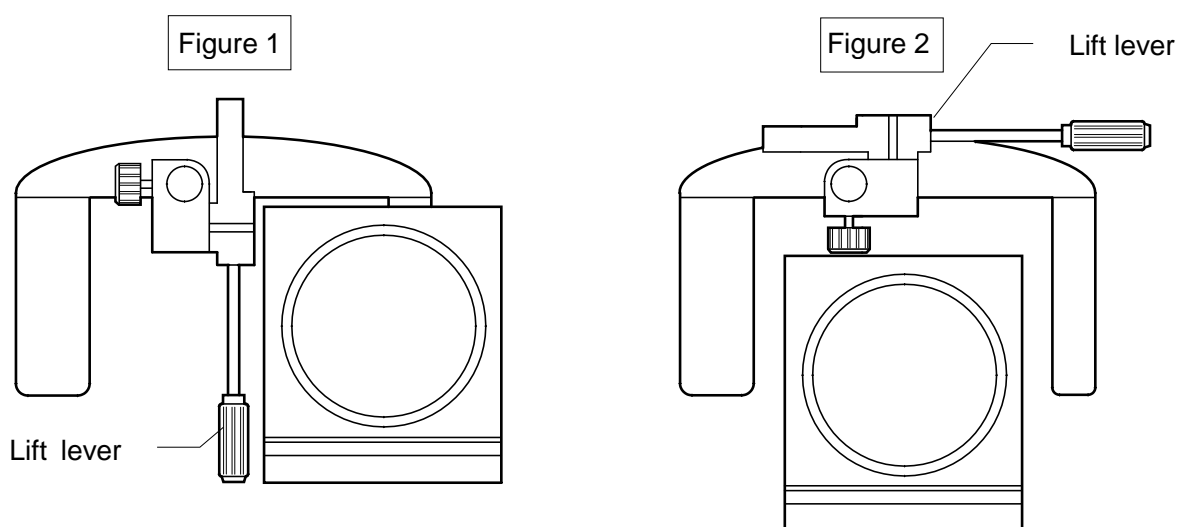
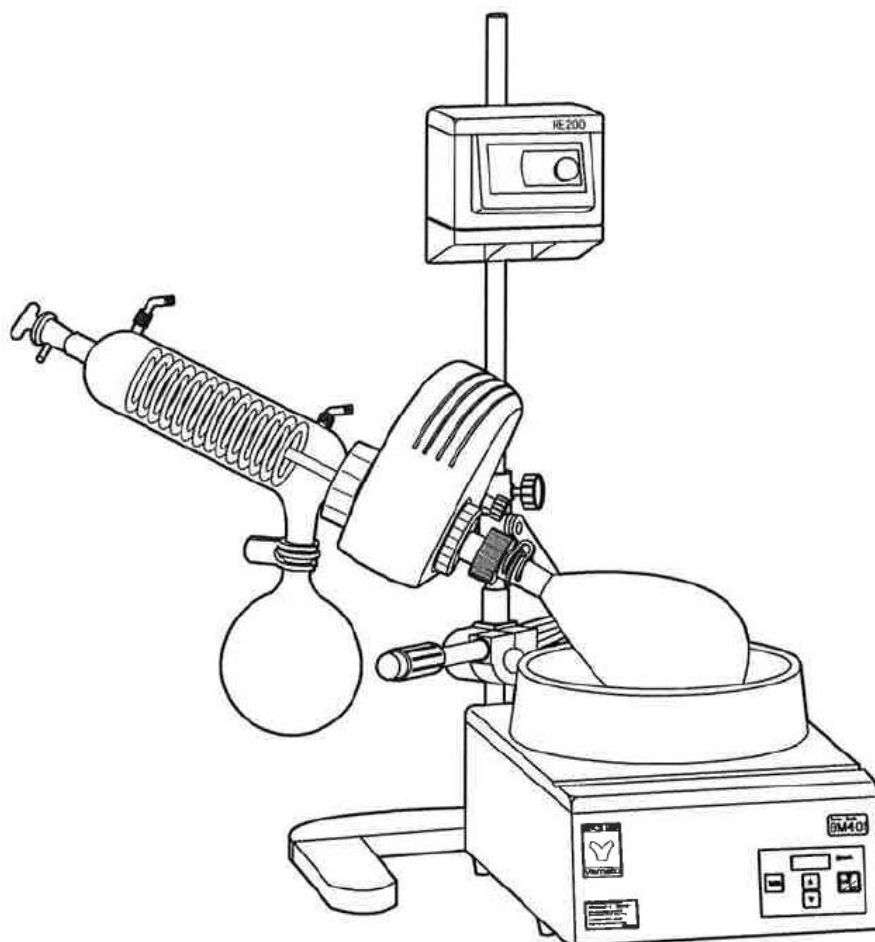

Depending on available space and access, the lift lever may be positioned out in front (figure 1) or behind (figure 2).

3. COMPONENT NAMES & FUNCTIONS

Unit Overview

External Views

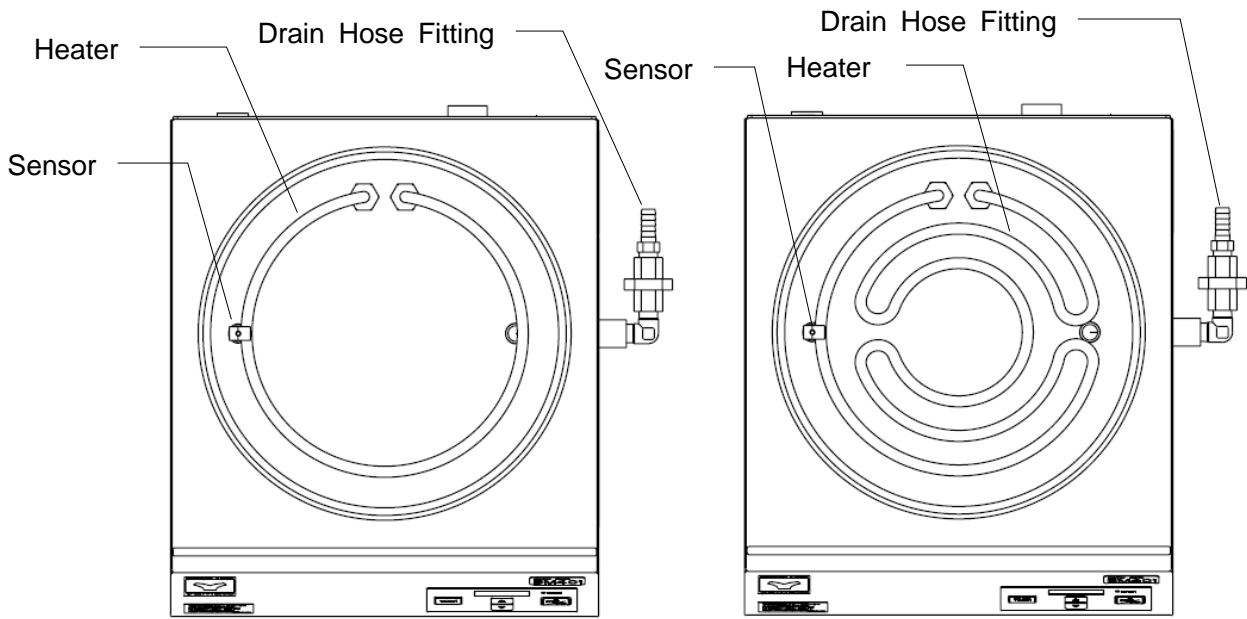
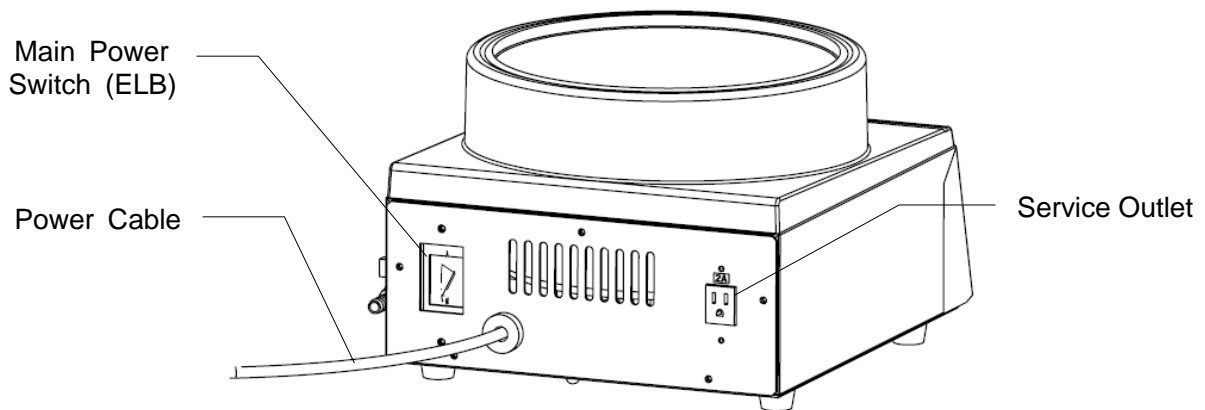
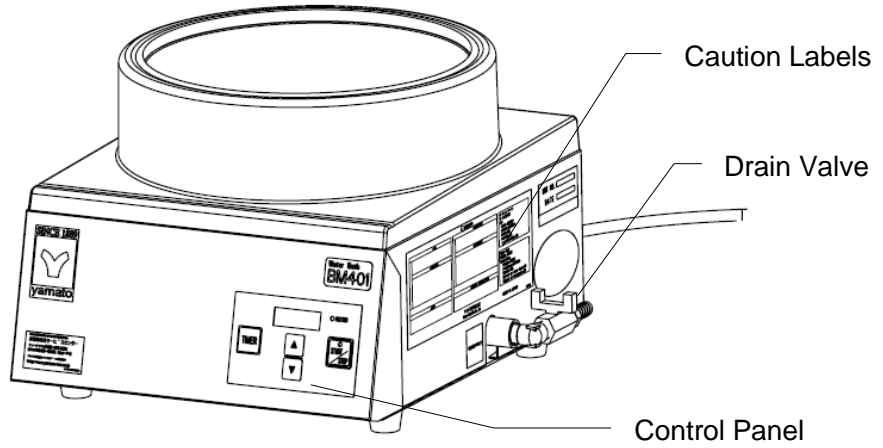

BM401

BO601

3. COMPONENT NAMES & FUNCTIONS

Unit Overview

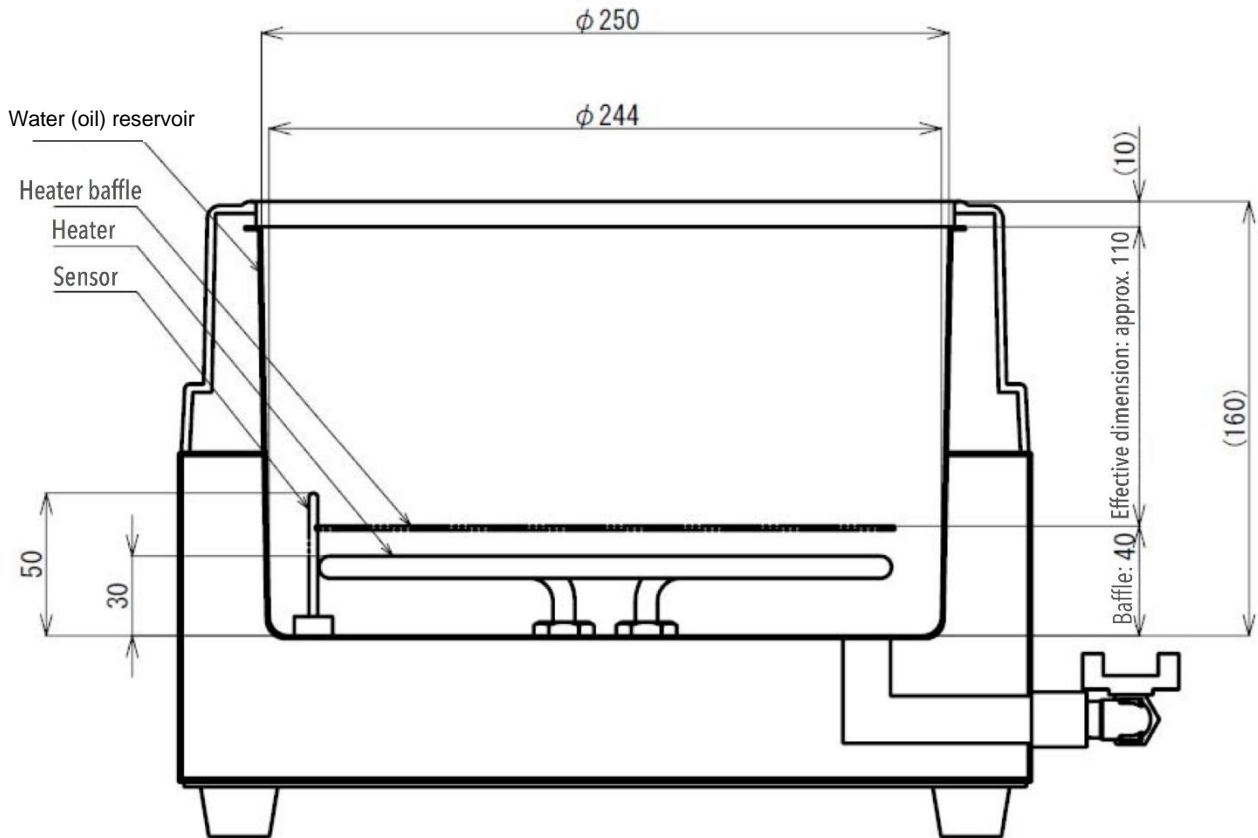

3. COMPONENT NAMES & FUNCTIONS

Control Panel

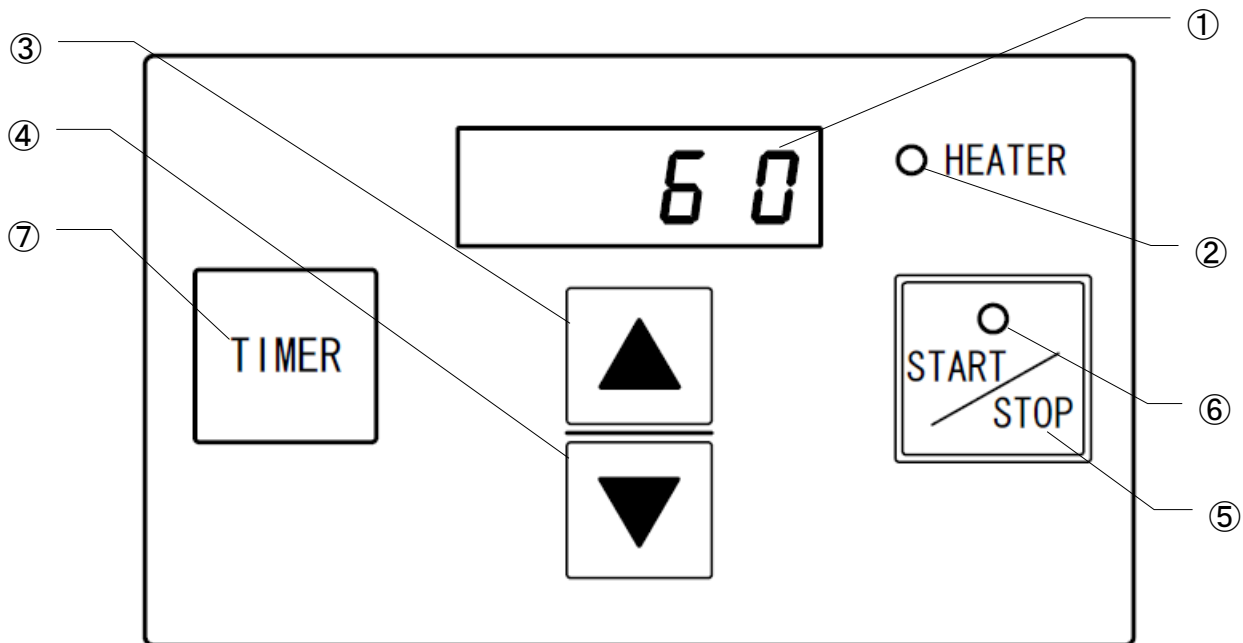











#	Item	Description
1	Temperature display	Normally displays temperature in reservoir. Depending on panel operation, times and other values may be displayed. When an error occurs, the error code is displayed.
2	Heater lamp	Illuminates whenever heater is drawing power.
3	Up arrow key	Pressed to increase a setting value/parameter
4	Down arrow key	Pressed to decrease a setting value/parameter
5	Start/Stop key	Pressed to start or stop operations. Pressing and holding for approximately 1 second turns controls ON/OFF.
6	Operation lamp	Illuminates during fixed value operations. Flashes during timed operations.
7	Timer key	Pressed to set Quick Auto Stop, Auto Stop and Auto Start modes. Enter submenus by pressing and holding. Keypad lock, calibration offset and power failure auto recovery submenus are all accessed using this key.

4. OPERATION PROCEDURES

Operation Modes & Functions

BM/BO series operation modes are outlined in the table below:

No.	Name	Description
1	Constant Temp Mode	Set desired temperature using $\Delta \nabla$. Press and hold  to start operation. Press  again to stop operation.
2	Quick Auto Stop Mode	Press  while constant temp mode is running. Select  and set stop timer using $\Delta \nabla$. Press and hold  to start quick auto stop mode.
3	Auto Stop Mode	Press  while unit is in standby. Select  and set operation time using $\Delta \nabla$. Press and hold  to start auto stop mode.
4	Auto Start Mode	Press  twice while unit is in standby. Select  and set operation time using $\Delta \nabla$. Press and hold  to start auto start mode.

BM/BO series safety features are outlined in the table below:

No.	Name	Description
1	Overheat Prevention Devices	<p>① Overheat prevention function: This function is set to automatically activate (manual reset) when actual temperature exceeds setting by 40°C. [Er06] appears in the display screen. Turn off the main power switch and call for service. Unit recovers when problem source is eliminated and unit is restarted.</p> <p>② Thermal fuse: Unit contains a thermal fuse which will cut power to the heater in the event that the overheat prevention function mentioned above fails to operate. If thermal fuse is activated (e.g. blown), call for service. Repair by a professional technician is required</p>
2	Main Power Switch	Circuit breaking power switch is located on the rear panel of unit. Switch will trip if power surges or when electrical leaks are detected. If power switch is tripped, call for service.

4. OPERATION PROCEDURES

Operation Modes & Functions

BM/BO maintenance functions are outlined in the table below.
To enter the maintenance menu, press and hold TIMER for four seconds.

	Name	Description
1	Keypad Lock	This function prevents changes to temperature and other settings by disabling the keypad during operation. Select [on] or [oFF] using $\Delta \nabla$. [on] disables all keys except TIMER. [oFF] cancels keypad lock, enabling all keys.
	Calibration Offset	The offset function works to correct discrepancies found between the reservoir temperature reading, as seen on the display and actual fluid temperature, as taken manually, by matching temperature setting to the actual temperature. Values may be adjusted either side of 0 over the entire thermal span of unit. Press TIMER to display CAL . Enter a correction value. Negative values increase temperature while positive values decrease temperature. (Example: a value of -2 would increase reservoir temperature by 2°C.)
4	Power Failure Recovery	The recovery function selects whether or not to continue an operation following a power failure. On: recovers and continues operation following a power failure. OFF: terminates operation (factory default) following a power failure. Select P on using TIMER, then select [on] or [oFF] using $\Delta \nabla$.

4. OPERATION PROCEDURES

Mode & Function Flow

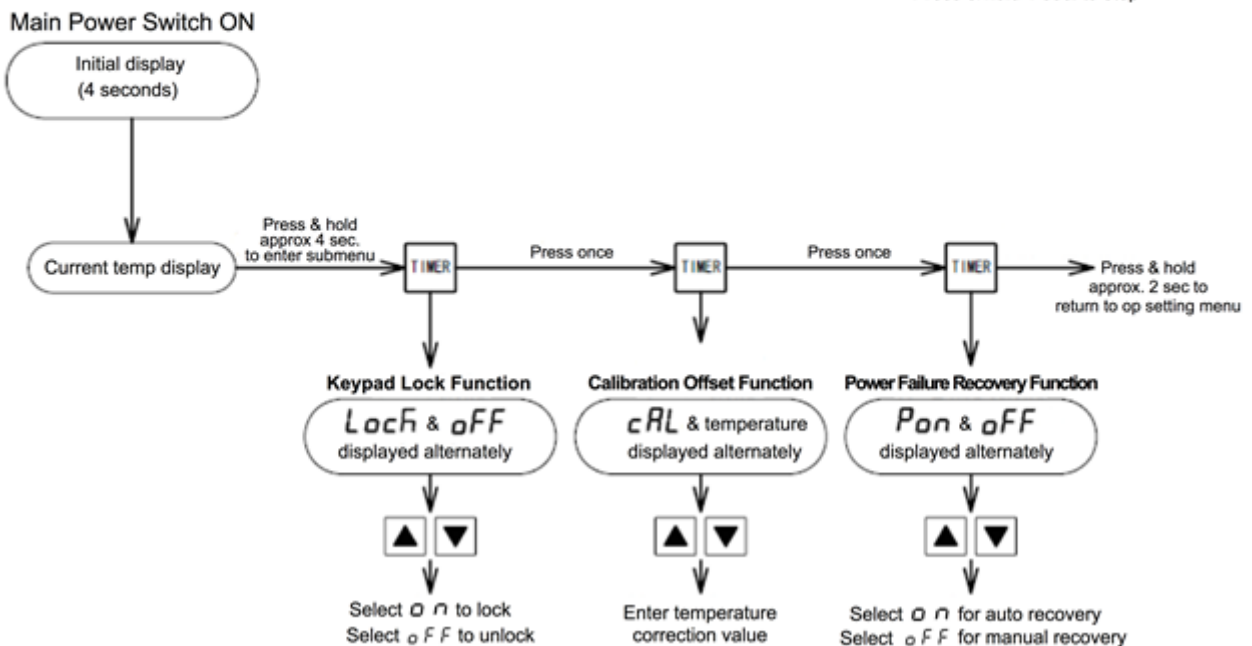
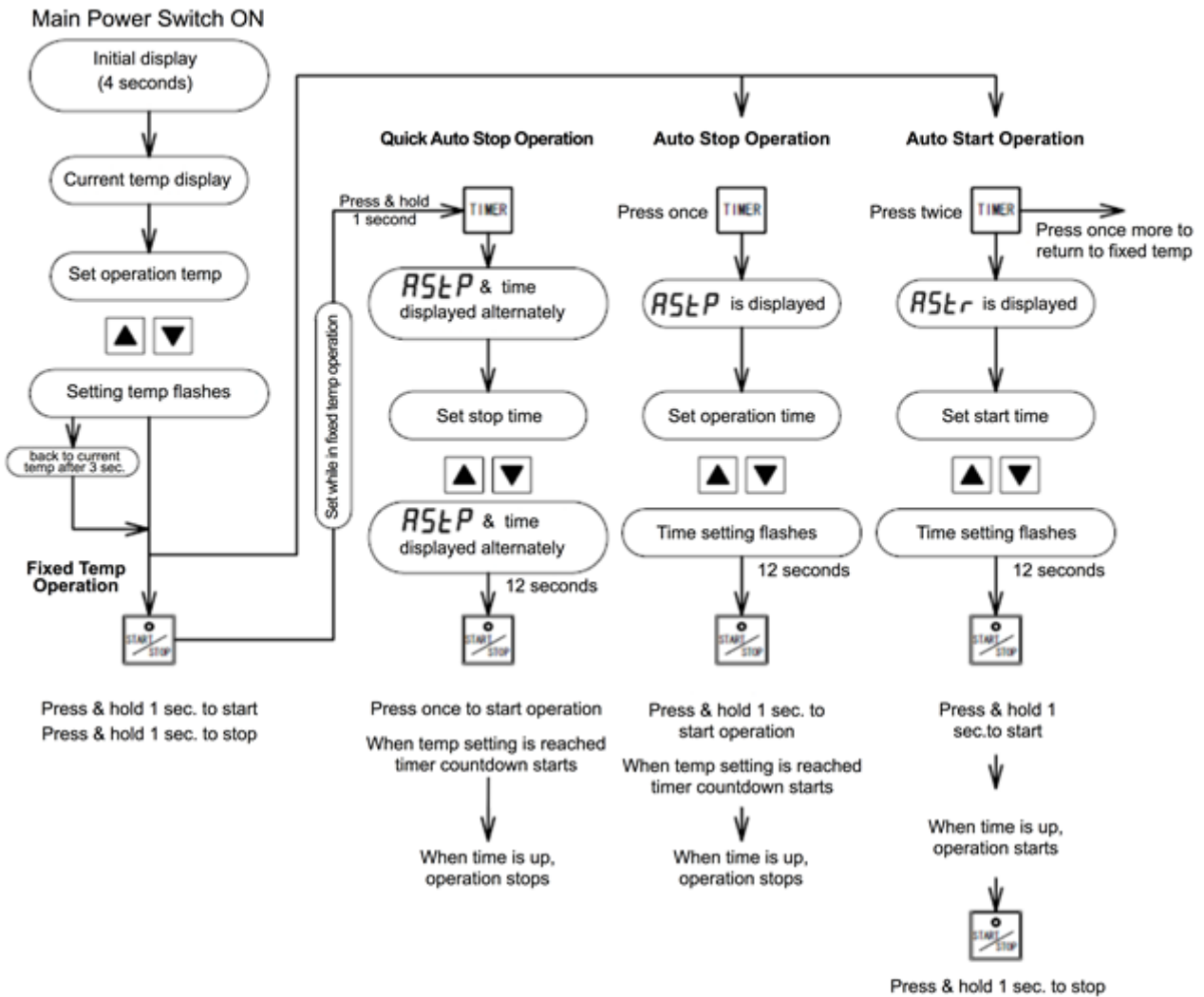

4. OPERATION PROCEDURES

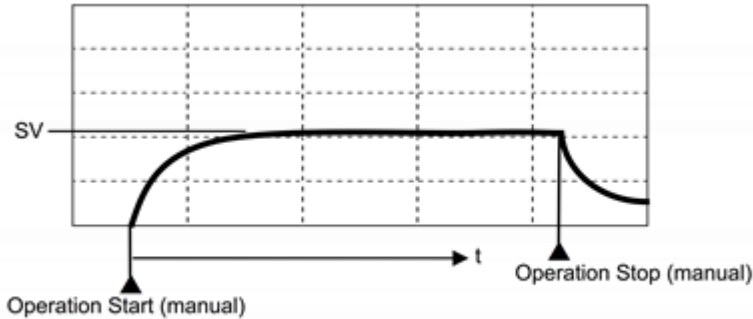

Constant (Fixed) Temperature Mode

Constant Temperature mode is a general use, continuous operation mode (started/stopped manually).





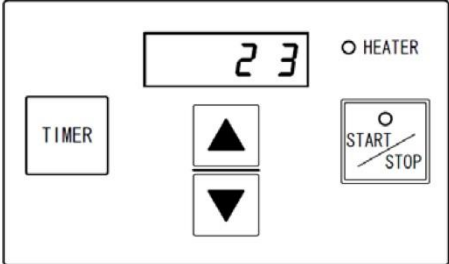
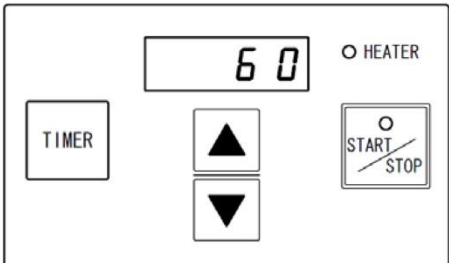
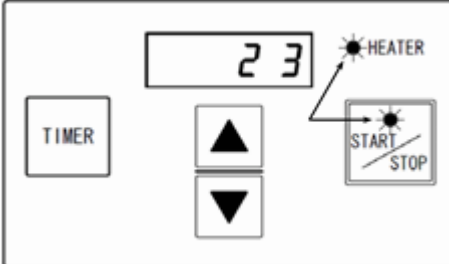







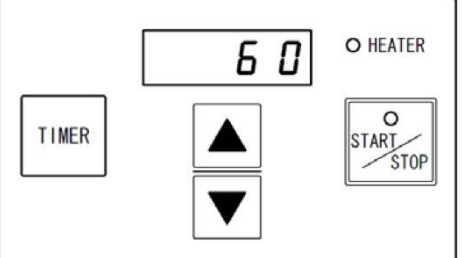

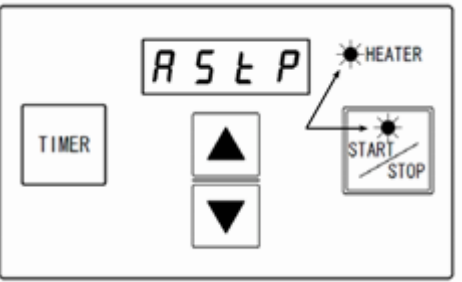
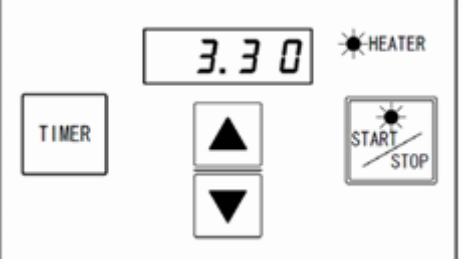
SV=Temperature Setting Value, t=Time

Setting Constant Temperature mode

1	<p>Turn power on</p> 	<p>Turn main power switch ON. Initial screen will appear for approximately 4 seconds and change to standby screen, showing current reservoir temperature.</p>
2	<p>Set temperature</p> 	<p>Press either ▲ or ▼. Previous temperature setting begins flashing in display. ▲ increases value, while ▼ decreases value. Display value remains flashing while setting takes place. If setting is left unmanipulated for more than 3 seconds, display reverts to standby screen (current reservoir temperature)</p>
3	<p>Start operation</p> 	<p>Press  for about 1 second to start operation. Operation lamp turns on. Heater lamp also turns on as heat builds. As reservoir nears temperature setting, heater lamp begins to flash.</p>

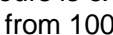

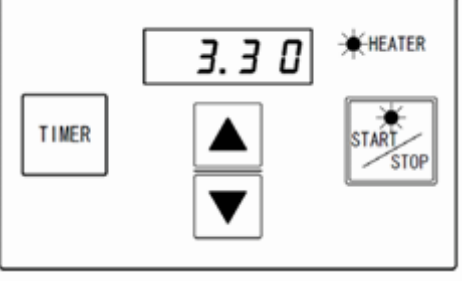
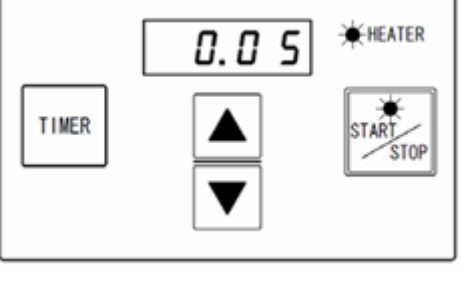
4. OPERATION PROCEDURES

Constant (Fixed) Temperature Mode

Quick Auto Stop mode adds auto stop timer function to running constant temperature mode.		
4	<p>Stop operation</p> 	<p>Press  for about 1 second to stop operation. Operation lamp turns off. Standby screen (current reservoir temperature) is restored.</p>
5	<p>Adding auto stop to fixed temp operation (quick auto stop mode)</p>  	<p>Press  while constant temperature operation is in progress.</p> <p><i>AS t P</i> and previously set time are displayed alternately.</p> <p>Using  , set desired remaining operation time.</p> <p>Time setting is shown in 1 minute units from 0 hours, 0 minutes () ~ 99 hours, 59 minutes ().</p> <p>When 100 hours is exceeded, time is displayed in 10 minute units from 100 hours, 0 minutes () ~ 999 hours, 50 minutes ().</p>
6	<p>Start timed operation</p>  	<p><i>AS t P</i> and time setting are displayed alternately for about 12 seconds.</p> <p>Press  while <i>AS t P</i> and time setting are displayed alternately. Operation lamp flashes for about 1 second and quick auto stop operation begins.</p> <p>When reservoir temperature reaches temperature setting, timed operation starts and timer begins counting down.</p> <p>If reservoir has already reached temperature setting before quick auto stop function is set, timer may be started by pressing . Display shows current reservoir temperature and remaining time alternately.</p>

4. OPERATION PROCEDURES

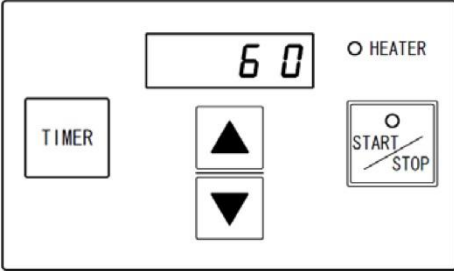
Constant (Fixed) Temperature Mode

7	Operation stop 	<p>Operation stops automatically when time is up. Standby screen is restored. HEATER and operation lamps shut off.</p> <p>To end operation before time is up, press and hold  for about 1 second. Operation stops and operation lamp shuts off.</p>
---	--	--

Correcting or viewing settings.

Use \triangle / ∇ at any time to correct or view settings.

Press either \triangle or ∇ once to view temperature setting. Display will automatically revert to temperature reading after 4 seconds. To change the setting, press and hold \triangle or ∇ until desired temperature is attained. Unit will continue operation under new temperature setting.

Changing timer setting.

Press TIMER during operation to change timer setting. Unit enters setting menu and timer setting can be changed. When timer has been set using \triangle or ∇ , unit continues operation under new timer setting.

Note: when changing timer settings, new setting total must be longer than time already passed.

4. OPERATION PROCEDURES

Auto Stop Mode

Auto Stop mode allows an automatic stop time to be set in advance of operation.

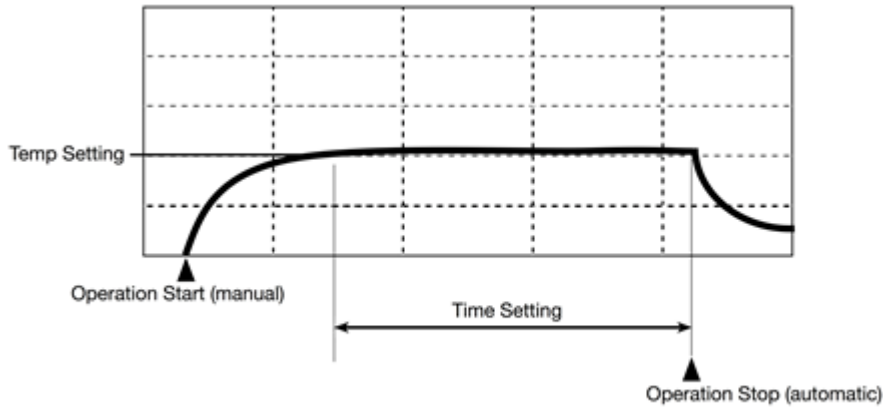



Setting Auto Stop mode

1	<p>Turn power on</p>	<p>Turn main power switch ON. Initial screen will appear for approximately 4 seconds and change to standby screen, showing current reservoir temperature.</p>
2	<p>Set temperature</p>	<p>Press either ▲ or ▼. Previous temperature setting begins flashing in display. ▲ increases value, while ▼ decreases value. Display value remains flashing while setting takes place. If setting is left unmanipulated for more than 3 seconds, display reverts to standby screen (current reservoir temperature)</p>
3	<p>Set Auto Stop function</p>	<p>Press . <i>A S t P</i> shows in display.</p>

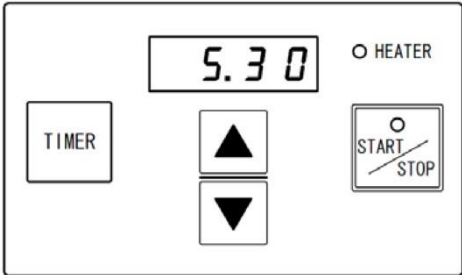
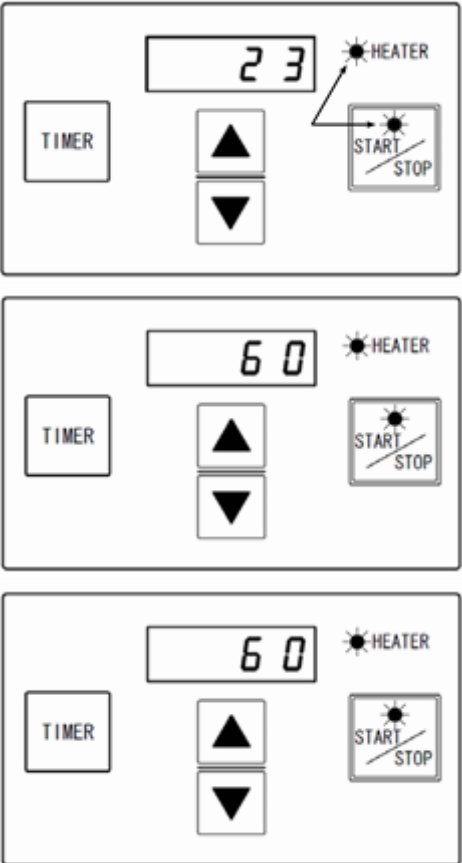

4. OPERATION PROCEDURES

Auto Stop Mode

<p>4</p>	<p>Set operation time</p> 	<p>Pressing either of the ▲ ▼ keys causes time setting value to begin flashing. Use these keys to set desired operation time.</p> <p>Time setting is shown in 1 minute units from 0 hours, 0 minutes (<u>0.00</u>) ~ 99 hours, 59 minutes (<u>99.59</u>).</p> <p>When 100 hours is exceeded, time is displayed in 10 minute units from 100 hours, 0 minutes (<u>100.00</u>) ~ 999 hours, 50 minutes (<u>999.50</u>).</p>
<p>5</p>	<p>Start operation</p> 	<p>Press  for about 1 second to start operation. Operation lamp turns on. Heater lamp also turns on as heat builds.</p> <p>As reservoir nears temperature setting, heater lamp begins to flash.</p> <p>When reservoir temperature reaches temperature setting, timed operation starts and timer begins counting down.</p> <p>Display shows current reservoir temperature and remaining time alternately.</p>

4. OPERATION PROCEDURES

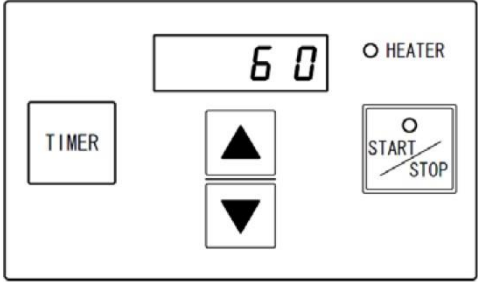
Auto Stop Mode

6	Operation stop 	<p>Operation stops automatically when time is up. Standby screen is restored. HEATER and operation lamps shut off.</p> <p>To end operation before time is up, press and hold  for about 1 second. Operation stops and operation lamp shuts off.</p>
---	--	--

Correcting or viewing settings.

Use \triangle ∇ at any time to correct or view settings.

Press either \triangle or ∇ once to view temperature setting. Display will automatically revert to temperature reading after 4 seconds. To change the setting, press and hold \triangle or ∇ until desired temperature is attained. Unit will continue operation under new temperature setting.

Changing timer setting.

Press TIMER during operation to change timer setting. Unit enters setting menu and timer setting can be changed. When timer has been set using \triangle or ∇ , unit continues operation under new timer setting.

Note: when changing timer settings, new setting total must be longer than time already passed.

4. OPERATION PROCEDURES

Auto Start Mode

Auto Start mode allows an automatic start time to be set in advance of operation.

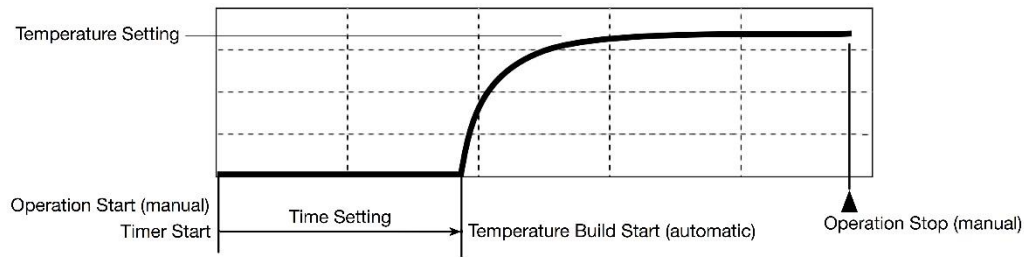

Setting Auto Start Mode

1 Turn power on

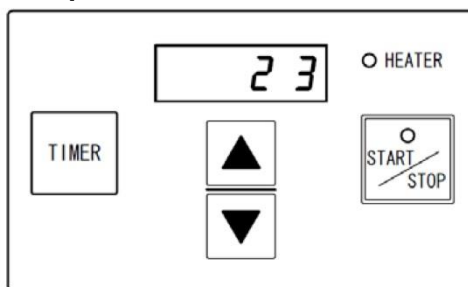

Turn main power switch ON. Initial screen will appear for approximately 4 seconds and change to standby screen, showing current reservoir temperature.

2 Set Temperature

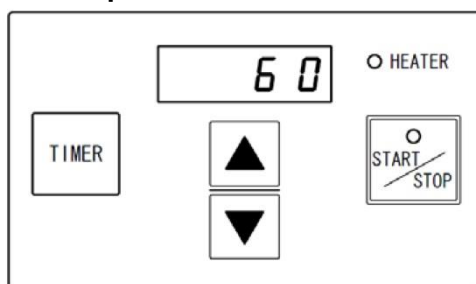

Press either ▲ or ▼. Previous temperature setting begins flashing in display.

▲ increases value, while ▼ decreases value. Display value remains flashing while setting takes place. If setting is left unmanipulated for more than 3 seconds, display reverts to standby screen (current reservoir temperature)

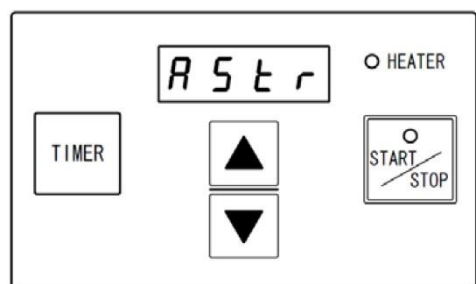

3 Set Auto Start function



Press **TIMER** twice. *A S t r* shows in display.

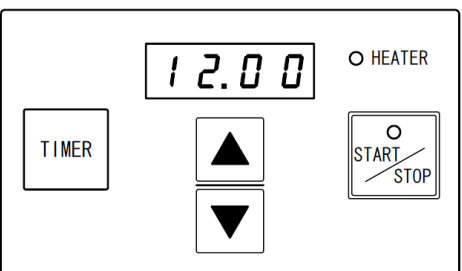
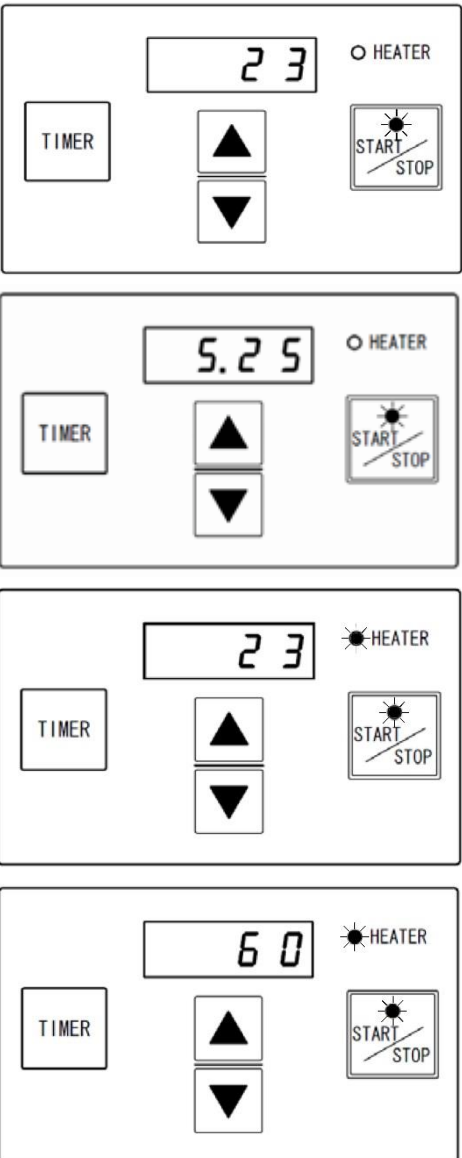

4. OPERATION PROCEDURES

Auto Start Mode

4	<p>Set start time</p> 	<p>Pressing either of the ▲ ▼ Key causes time setting value to begin flashing. Use these keys to set desired start time.</p> <p>Time setting is shown in 1 minute units from 0 hours, 0 minutes (<u>0.00</u>) ~ 99 hours, 59 minutes (<u>99.59</u>). When 100 h ours is exceeded, time is displayed in 10 minute units from 100 hours, 0 minutes (<u>100.00</u>) ~ 999 hours, 50 minutes (<u>999.50</u>).</p>
5	<p>Start operation</p> 	<p>Press and hold  for about 1 second. Unit enters standby and operation lamp flashes on and off for 2 seconds intermittently until operation begins. Current reservoir temperature and remaining time are shown in display alternately.</p> <p>When start timer is up, heater lamp lights and temperature begins building.</p>

4. OPERATION PROCEDURES

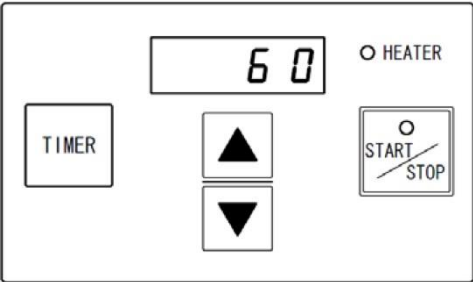
Auto Start Mode

6	<p>Operation stop</p> 	<p>Operation must be stopped manually.</p> <p>Press  for about 1 second to stop operation. Operation lamp turns off. Standby screen (current reservoir temperature) is restored.</p>
<p>Correcting or viewing settings. Use \triangle ∇ at any time to correct or view settings. Press either \triangle or ∇ once to view temperature setting. Display will automatically revert to temperature reading after 4 seconds. To change the setting, press and hold \triangle or ∇ until desired temperature is attained. Unit will continue operation under new temperature setting.</p> <p>Changing timer setting. Press TIMER during operation to change timer setting. Unit enters setting menu and timer setting can be changed. When timer has been set using \triangle or ∇, unit continues operation under new timer setting. Note: when changing timer settings, new setting total must be longer than time already passed.</p>		

4. OPERATION PROCEDURES

Overheat Prevention Settings

BM401/BO601 units feature a built-in safety device to automatically prevent overheating, plus a thermal fuse for redundancy.

Overheat prevention device operation:

The main overheat prevention device is set to activate at temperature setting plus 40°C, at which point power is cut and **Er06** is displayed. Recovery takes place when the overheat source is eliminated and the unit is restarted by turning the main power switch off and back on. The thermal fuse is set to break at 128°C (for BM500 and 510 models) or 192°C (for BO400 and 410 models), cutting power to the heater.

Caution:

- If hot water is added during operation, bringing temperature to 40°C or more beyond temperature setting, the unit interprets this as an overheating event. Power is cut to the heater, and **Er06** is displayed. If adding water/oil to reservoir becomes necessary while unit is running, cancel operation before adding.
- If overheating prevention devices activate outside of the above conditions, unit may be faulty. Turn OFF main power switch immediately, disconnect power cable and call for service.
- Overheating prevention functions are to prevent abnormal overheating and protect unit. They are NOT intended as test sample or specimen protection measures, nor are they intended as prevention against mishaps resulting from the negligent use of this product.

Power failures.

- In the event of a power failure, BM/BO units are set to stop and revert to standby (factory default) when power is restored to maintain safety.









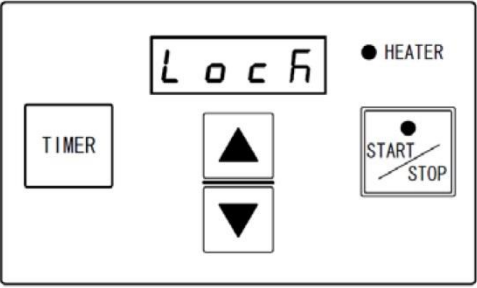

Press and hold START/STOP to resume the operation. Be advised, however, that any timed operations are cancelled and unit will only resume in fixed temperature mode.

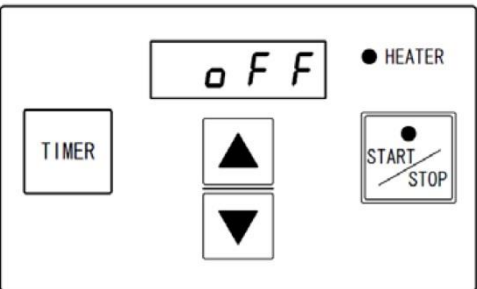
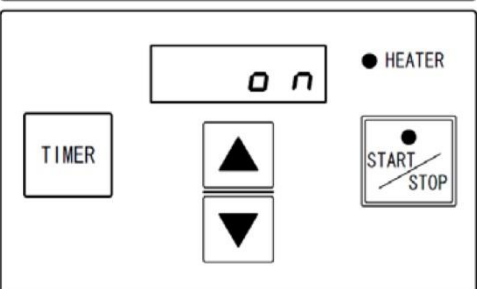
To restore operation automatically, be sure that **P o n** is set to **o n** in the sub-menu. Do not leave unit unattended when unit has been set to continue operation following a power loss.

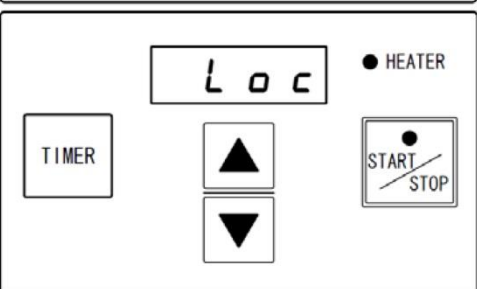
4. OPERATION PROCEDURES

Keypad Lock Function

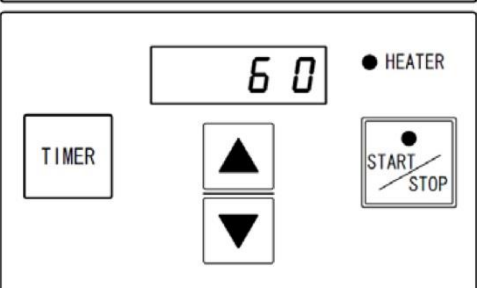
The keypad lock function prevents keys from being pressed erroneously during operation.

	<p>Press  for approximately 4 seconds and select <i>L o c H</i> from the sub-menu.</p>
	<p><i>o F F</i> and <i>L o c H</i> are displayed alternately.</p>
	<p>Press  to display <i>o n</i> and either press  for 2 seconds or simply wait for unit to automatically revert to standby (about a minute).</p>
	<p>When keypad lock is enabled, all except the  and  keys are disabled. If either of the   are pressed <i>L o c</i> is shown in the display.</p>
	<p>To disable the keypad lock function, press  for approximately 4 seconds. <i>o n</i> and <i>L o c H</i> are displayed alternately. Select <i>o F F</i> using .</p>

4. OPERATION PROCEDURES

Calibration Offset Function

Set Calibration Offset

Calibration offset is a function which corrects the difference between the temperature in furnace and that of controller (sensor temperature) if arises. The function parallel corrects the difference either to the plus or minus side within the whole temperature range of unit.。

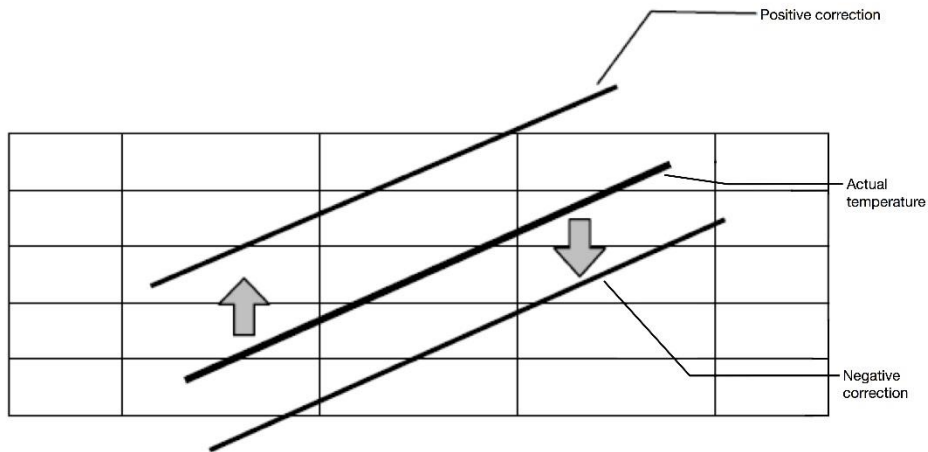



- ❖ If a negative value is entered, bath temperature rises according to the value entered. If a positive value is entered, bath temperature decreases by the value entered.

Example:

A temperature reading of 60°C and an actual temperature of 58°C would call for an offset value of -2, bringing the actual temperature up 2°C, to 60°C.

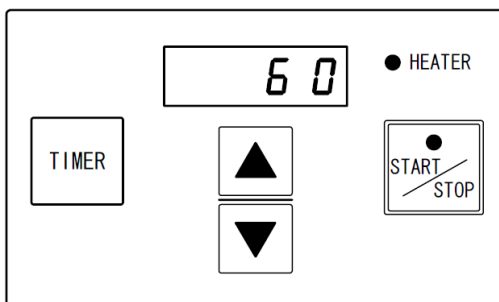
- ※ The calibration offset of -2°C will be effect to the whole temperature range(BM401; 0~100°C and BO601 ; 0~180°C). The calibration offset value must be changed because of placing the sample(s) and set temperature, so be carefull to them.



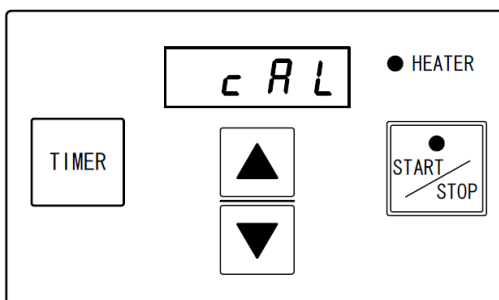

Press and hold  approximately 4 seconds. Press once more to select **c R L** from the submenu.

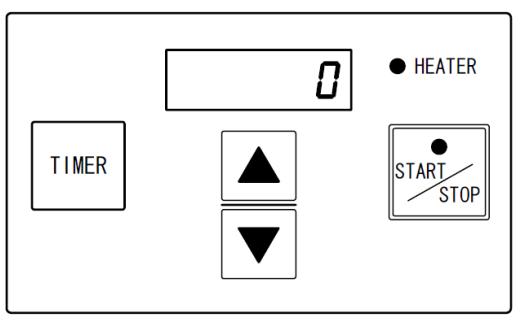
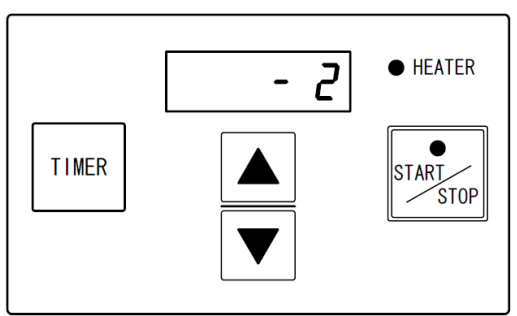
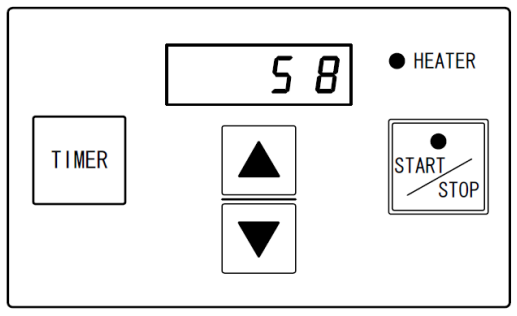

4. OPERATION PROCEDURES

Calibration Offset Function

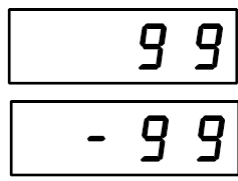
	<p>CEL and offset value 0 flash alternately in the display.</p>
	<p>Enter offset value using ▲ ▼.</p>
	<p>Press and hold  for 2 seconds or simply wait until display reverts to temperature indication screen.</p>
	<p>Maximum calibration offset adjustment is 99°C to either side of 0.</p>
<p>BM/BO units contain no agitator or stirring device. Water (oil) in reservoir mixes naturally, causing temperatures differ in certain parts of the reservoir, particularly top to bottom when used in combination with a rotary evaporator, and when items are placed on the heater baffle. Employ calibration offset function accordingly.</p>	

4. OPERATION PROCEDURES

Power Failure Recovery

Using the power loss recovery function.

The automatic power loss recovery function allows the operator to choose whether operation should continue or stop following a power failure. Factory default setting for this feature is .

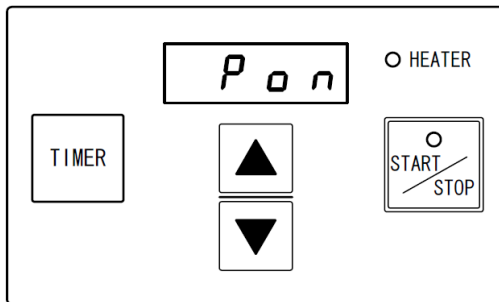

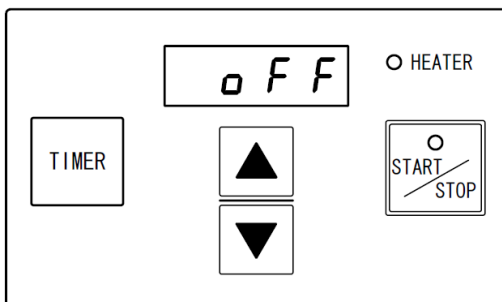

Press and hold  for 4 seconds, then press twice more to si *P o n* from submenu.

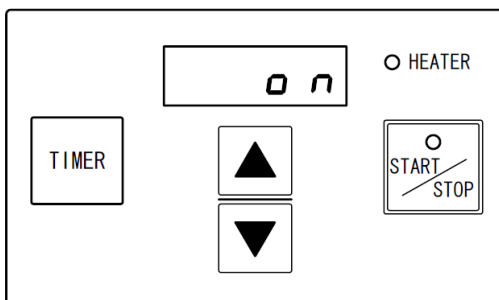

P o n and *o F F* flash alternately in the display.



Select *o n* using  for function to restore operation in the event of a power failure.

Select *o F F* using  to stop operation following a power failure.

Press and hold  for 2 seconds or simply wait until display reverts to temperature indication screen.

Fire hazard:

Do not leave unit unattended following a power failure when function is set to *o n* .

Advisories:

When running a timed operation and a power failure occurs, duration of power loss is not included in remaining time. Remaining time resumes from the moment when power is restored.

The service outlet on rear of unit is connected directly to the main power switch, not to the control panel. The power failure recovery function, therefore, does not apply to devices connected to the service outlet. A Yamato rotary evaporator (RE200), in the event of a power interruption, will begin operating once again when power is restored.

5. HANDLING PRECAUTIONS



WARNING!

1. DO NOT process hazardous or harmful substances.



Never process, place or use explosive/flammable substances or materials that contain explosives or flammables in this unit. Explosion or fire may be caused resulting in serious injury or death. (Refer to P.44)

2. Resin container advisory.



When using resin containers for processing, confirm that they conform to the heating specifications of this unit. Heating non-conforming resin containers presents a fire hazard which may result in serious injury or death.

3. DO NOT operate equipment when abnormalities are detected.



If unit begins emitting smoke or abnormal odors for reasons unknown, turn off main power switch immediately, disconnect power cable from power supply, and contact a local dealer or Yamato sales office for assistance. Continuing to operate without addressing abnormalities may cause fire or electric shock, resulting in serious injury or death. Never attempt to disassemble or repair unit. Repairs should be always be performed by a certified technician.

4. Install ventilation hood and fire extinguisher.



Devices which heat silicon oil present a fire hazard and may emit harmful fumes. Always be sure that a ventilation hood is installed over such devices, with a fire extinguisher in close proximity.

5. Handle the sample container carefully after the operation at high temperature.



Inside of the bath and the device are heated during and after operation. Do not touch by hands. Operate with thick leather gloves to avoid any burns.

6. DO NOT heat without appropriate fluid in reservoir.



Running unit without fluid will degrade the heating element, affecting the overall life of the heater, and also presents a fire hazard.

Confirm that reservoir contains water (oil) before operation and add if fluid levels are low. Reservoir fill capacity is approximately 3.8 liters.



BM/BO units contain a thermal fuse, which cuts power to heater in the event of overheating, but should not be substituted as prevention against keeping reservoir filled to appropriate levels. If thermal fuse is blown, fuse will need to be replaced requiring unit to be serviced by a certified technician. Contact Yamato customer service center for assistance.

7. DO NOT leave operating equipment unattended.



Do not leave units requiring oil unattended while in operation. Heated oil presents a fire hazard which could result in serious injury or death.

5. HANDLING PRECATIONS



1. DO NOT climb on equipment.

 Do not attempt to climb onto unit or substitute it for a proper stepladder. Units are not designed to support bodily weight and damage may result. In addition, unit may become unstable and tip over or fall resulting in equipment damage, serious injury or death.

2. DO NOT place items on equipment.

 Placing items or objects of any kind on unit may cause it to become unstable and tip over, possibly resulting in equipment damage, injury or death.

3. DO NOT operate equipment during thunderstorms.

 In the event of a thunderstorm, turn off main power switch, and disconnect power cable immediately. A direct lightning strike may cause equipment damage fire or electric shock, resulting in serious injury or death.

4. DO NOT process corrosive process samples.

 Acidic samples may cause corrosion to sensor and heater, despite stainless steel construction. Avoid processing corrosive items.

5. Use appropriate heating temperatures.

 Maximum working temperature is 95°C and 180°C for BM401 and BO601 respectively. Do not attempt to heat above specified temperature range. Fire may result, causing serious injury or death.

6. Overnight and extended storage.

 Whenever unit is not in operation, stored overnight or put in storage, always turn off main power switch and disconnect power cable.

7. Do not lay down sideways.

 Do not lay this equipment down sideways. It may cause failures of this equipment.

8. Do not spill liquid at adding liquid to the bath.

 Do not pour too much liquid into the bath to over-flow and/or spill liquid on the equipment. It may cause electrical leakage and fire.

9. Oil and water to use

 Using purified or distilled water in BM401 model water bath is recommended to prevent mineral deposit accumulation. Do not continue adding water without changing or washing. Rust and corrosion will result.

Never use any fluid other than proper specification silicon oil in BO model oil bath. Periodically change oil and wash the bath container.

10. Give attention to temperature distribution and its working range.

 Does not have a stirring function on this bath. Because this bath is a natural convection, liquid temperature difference in the water or oil bath will occur. In addition, the maximum operating temperature depends on the environment and conditions of use. Low ambient temperature, such as in the wind blowing location and high altitude, the temperature may not be able to reach to the setting temperature according to the performance specification.

11. Read instruction manual before operation.

 Always read instruction manual(s) for all equipment, thoroughly, before beginning setup, installation and operation.

6. MAINTENANCE PROCEDURE

Inspection and Maintenance



Warning

- Be sure that main power switch (ELB) is OFF before daily inspection and maintenance of BM401 and BO601 units
- When oil is applied to operation panel etc., wipe off the oil well. It may cause an earth leakage or an electric shock.
- Perform inspections and maintenance when inside of chamber is at room temperature.
- Never attempt to disassemble unit.



Caution

- Clean unit using soft damp cloth. Never use benzene, paint thinner, scouring powder, scrubbing brush or other abrasives and solvents to clean unit. Superficial damage and/or discoloration, as well as deformity to some components may result.
- Wipe off the dirt of inner bath with dry cloth.
- Be careful not to give cracks to the heater.



Inspect monthly

- Inspect main power switch (ELB) ON and OFF function
 - Prepare unit for inspection by connecting power cable to a facility outlet or terminal.
 - Confirm that main switch (ELB) is "OFF" then, turn main switch (ELB) back "ON".
 - With the main switch "ON", depress the test button on the main switch (ELB) using a ball-point pen or other fine-tipped object. If main switch (ELB) shuts off, it is functioning normally.

◆ Contact a local dealer or Yamato sales office for further assistance.

7. EXTENDED STORAGE & DISPOSAL

Extended Storage / Unit Disposal

 Warning	 Caution
When not using this unit for long term <ul style="list-style-type: none"> ● Turn off the power and disconnect the power cord. ● Extract oil/water of the bath, and wipe it off completely. 	Unit disposal. <ul style="list-style-type: none"> ● Wipe off oil completely before disposing. ● Do not leave unit unattended, or in a place where children may have access. ● 通常は粗大ゴミ扱いで処分してください。

Disposal Considerations

Dispose of or recycle this unit in a responsible and environmentally friendly manner. Yamato Scientific Co., Ltd. strongly recommends disassembling unit, as far as is possible, in order to separate parts and recycle them in contribution to preserving the global environment.

Component	Material
Exterior Parts	
Exterior	Chrome-free electrogalvanized carbon steel sheet metal, finished in chemical-proof, baked-on coating
Protective reservoir cover	Aluminum alloy, 耐薬品性焼付塗装
Water (oil) reservoir	Stainless steel sheet metal
Baffle	Stainless steel sheet metal
Gasket	Ethylene propylene rubber
Rubber feet	Ethylene propylene rubber
Plates	Resin
Heat insulation material	Glass wool
Major electrical components	
Switches and Relays	Resin composites, copper and other material
Operation Panel	PET resin film
Printed Circuit Boards	Fiber glass composites and other material
Heater	Stainless steel, Magnesium oxide, nichrome and other
Power Cable	Composite of synthesized rubber coating, copper, nickel and other compound material
Wires	Fire-retardant vinyl, copper, nickel and other material
Sensor (K Sensor)	Stainless steel and other material

8. TROUBLESHOOTING

Error Code Guide

Possible error messages are outlined below.

Power output to heater is stopped and operator is notified of abnormalities by a corresponding error code in the display. Make note of the code, turn off power and call for service, if necessary.

Display code	Description	Cause/Solution
ER01	Temperature sensor error	Temperature sensor faulty or severed from circuit. Check/replace the sensor. Restart to clear error.
ER06	Overheat	Overheating prevention device has been activated by overheating, or by a temperature control error. Restart to clear error. If restarting does not clear error, the control board may need replacing. Call for service.
ER15	Memory error	Setting value memory error. Replace memory board.
Blank Display	Thermal fuse thrown	Thermal fuse has been blown. Call for service to have fuse replaced.

8. TROUBLESHOOTING

Troubleshooting Guide

Symptom	Check
Unit does not power on.	<ul style="list-style-type: none"> • Power cable is not securely inserted into the outlet • Power failure is in progress. • Water/oil level is low.
Control panel remains blank after pressing  .	<ul style="list-style-type: none"> • Inadequate voltage from power supply (must be within $\pm 10\%$ voltage rating). • Power cable not properly connected • Faulty control board*
Circuit breaker (main power switch) trips.	<ul style="list-style-type: none"> • Unit exterior may be wet. • Short-circuit has occurred*
Temperature reading erratic.	<ul style="list-style-type: none"> • Surrounding temperature is extreme (too high/low) • Inadequate voltage from power supply (must be within $\pm 10\%$ voltage rating). • Test sample temperature affecting bath temperature • Re-evaluate unit placement
Temperature does not build	<ul style="list-style-type: none"> • Heater is faulty or severed from circuit* • Overheat prevention device has activated and cut power to circuit (Error 6 showing in display). Reset unit. • Thermal fuse has blown*
Temperature reading and actual fluid temperature differ	<ul style="list-style-type: none"> • Calibration offset value is set too high or too low (See P.31) • Fluid quantity is outside sensor capacity to measure • Sample container is contacting sensor

*Call for service.

If problems persist, turn off main power switch immediately, disconnect power cable and call for service.

9. SERVICE & REPAIR

When requesting a repair

Requests for Repair

When a problem occurs, terminate operation immediately, turn off main power switch and disconnect power cable.

Contact a local dealer or Yamato sales office for assistance.

The following information is required for all repairs.

- Model name
- Serial Number
- Date (year/month/day) of purchase
- Description of problem in as much detail as possible

} Refer to production ID plate on unit

Guaranteed Supply Period for Repair Parts

Guaranteed maximum supply period for repair parts is 7 (seven) years from date of discontinuation for BM/BO series water/oil baths. "Repair parts" is defined as components which, when installed, allow for continued unit operation.

10. SPECIFICATIONS

Product		Water Bath	Oil Bath
Model		BM401	BO601
System		Natural convection	
Usable exterior temperature		±5~35°C	
Power rating		AC 115V, 11A (2A service outlet inclusive), 50/60Hz, tolerable variance: ±10%	
Performance*1	Temperature control range	Room temp. +5°C~95°C	Room temp. +10°C ~180°C
	Temperature setting range	0°C ~100°C	0°C ~180°C
	Temperature adjustment accuracy*2	±3°C (at 60°C)	±3°C (100°C)
Configuration	Exterior	Chrome free electro-galvanized carbon steel, coated w/chemical-proof baked-on finish	
	Fluid Reservoir	Stainless steel	
	Insulation	Glass wool	
	Heater element	Stainless steel tubing	
	Heater capacity	1kW	
	Service outlet	AC 115V, 2A	
	Drain port	Stop valve fitting (outer diameter: 10.5mm)	
Control functions	Control system	PID	
	Temperature setting, display system	▲/▼ keys, LED display	
	Timed operation	1 minute ~ 99 hours, 59 minutes (in 1 minute intervals) 100 hours, 0 minutes ~ 999 hours, 50 minutes (in 10 minute intervals)	
	Operation modes	Constant temperature operation Timed operation (Quick Auto Stop, Auto Stop, Auto Start)	
	Addition functions	Calibration offset, power loss recovery, keypad lock	
	Heater Control	Triac w/zero-cross control	
	Sensor	K-Thermocouple	
Safety functions	Controls	Self-diagnostic (temperature sensor failure detection, overheat prevention function)	
	Earth Leakage Breaker	15A Leak Current/Short Circuit/Over-current Protection, Rated Current Sensitivity 30mA	
	Other	Thermal fuse, protective reservoir cover	

10. SPECIFICATIONS

Model		BM401	BO601	
Standard Measurements	Reservoir capacity	Approx. 7L		
	Reservoir dimensions*3	Inner diameter	Top: 250mm, Bottom: 244mm	
		Depth	150mm	
	Overall dimensions*3	Width	310mm (w/drain valve: approx. 360mm)	
		Depth	360mm	
		Height	230mm	
Weight		7kg	8kg	
Included items	Heater baffle	1		
	Instruction manual	1		

*1 Performance based on 100V AC power supply \pm 5, 23°C \pm 5°C External temp., 65%RH \pm 20% humidity, 86~106kPa atmospheric pressure, no test sample load.

*2 Yamato standard measurement values, based on KF-96-50cs silicon oil by Shinetsu Science Industries Co., Ltd. in BO601. Measurement values will vary depending on type of silicon oil used.

*3 Protrusions excluded.

11. WIRING DIAGRAM

BM401 · BO601

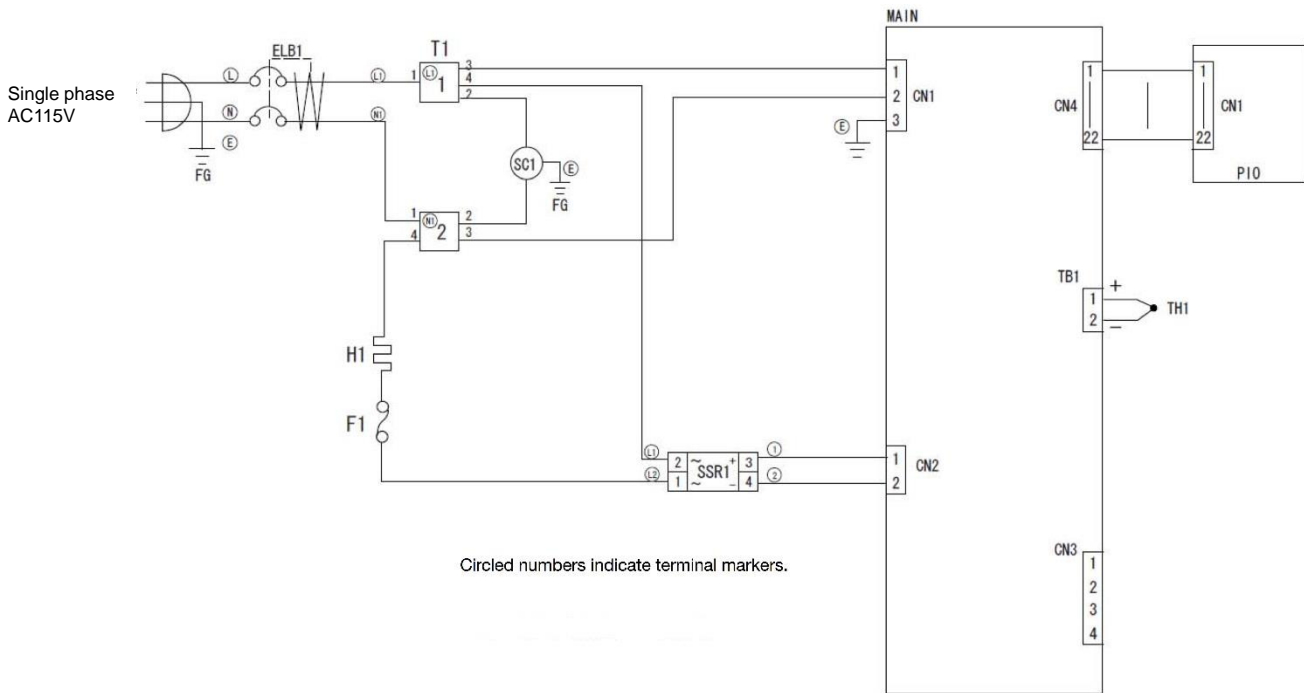

Wiring Diagram Glossary

Symbol	Component	Symbol	Component
ELB1	Earth Leakage Breaker	SC1	Service Outlet
T1	Wiring Terminal	F1	Thermal Fuse
H1	Heater	MAIN	Motherboard
SSR1	Solid State Relay	PIO	Display Board
TH1	Temperature Sensor		

12. LIST OF HAZARDOUS SUBSTANCES



Never attempt to process explosives, flammables or any items which contain explosives or flammables.

EXPLOSIVE

EXPLOSIVE:	Ethylene glycol dinitrate (nitro glycol), Glycerin trinitrate (nitroglycerine), Cellulose nitrate (nitrocellulose), and other explosive nitrate esters
	Trinitrobenzene, Trinitrotoluene, Trinitrophenol (picric acid), and other explosive nitro compounds
	Acetyl hidroperoxide (peracetic acid), Methyl ethyl ketone peroxide, Benzyl peroxide, and other organic peroxides

FLAMMABLE

COMBUSTIBLE:	Lithium (metal), Potassium (metal), Sodium (metal), Yellow phosphorus, Phosphorus sulfide, Red phosphorus, Celluloid compounds, Calcium carbide, Lime phosphate, Magnesium (powder), Aluminum (powder), Powder of metals other than magnesium and aluminum, Sodium hydrosulfite
OXIDIZING:	Potassium chlorate, Sodium chlorate, Ammonium chlorate, and other chlorate
	Potassium perchlorate, Sodium perchlorate, Ammonium perchlorate, and other perchlorate
	Potassium peroxide, Sodium peroxide, Barium peroxide, and other inorganic peroxide
	Potassium nitrate, Sodium nitrate, Ammonium nitrate, and other nitrate
	Sodium chlorite and other chlorites
INFLAMMABLE LIQUID:	Calcium hypochlorite and other hypochlorites
	Ethyl ether, Gasoline, Acetaldehyde, Propylene chloride, Carbon disulfide, and other flammable substances having a flash point of lower than -30°C
	Normal hexane, ethylene oxide, acetone, benzene, methyl ethyl ketone, and other flammable substances having a flash point of -30°C or higher but lower than 0°C
	Methanol, Ethanol, Xylene, Pentyl acetate (amyl acetate), and other flammable substances having a flash point of 0°C or higher but lower than 30°C
FLAMMABLE GAS:	Kerosene, Light oil (gas oil), Oil of turpentine, Isopentyl alcohol (isoamyl alcohol), Acetic acid, and other flammable substances having a flash point of 30°C or higher but lower than 65°C
	Hydrogen, Acetylene, Ethylene, Methane, Propane, Butane, and other flammable substances which assume a gaseous state at 15°C and 1 atm

(Source: Appendix Table 1 of Article 6 of the Industrial Safety and Health Order, Japan)

13. SETUP CHECKLIST

* Set unit up according to the following: (Confirm optional items or special specifications separately)

Model	Serial number	Date	Installed by (company or personnel name)	Installation approved by	Assessed by

No	Item	Procedure	Instruction manual reference	Assessed by
Specifications				
1	Included Items	Confirm actual items against list of included items.	10. Specifications – pg. 41	
2	Installation	<ul style="list-style-type: none"> Visually check the surrounding area. Caution: check for operational hazards.	2. Pre-operation Procedures – pg. 5	
Operation				
1	Power voltage	<ul style="list-style-type: none"> Measure line voltage (power terminal or outlet) with a voltmeter. Measure line voltage during operation. (must meet required rating). Caution: Confirm outlet rating or breaker power rating meets unit requirements.	2. Pre-operation Procedures – pg. 6	
			10. Specifications – pg. 41	
2	Operation	<ul style="list-style-type: none"> Start operation. BM: Add water, set the temperature to 50°C, and confirm stability. BO: Add silicon oil, set temperature to 100°C, and confirm stability.	2. Pre-operation Procedures – pg. 5	
			4. Operation Procedures – pg. 15	
			5. Handling Precautions – pg. 29	
3	Stop Operation	<ul style="list-style-type: none"> Stop operation. BO: Notify surrounding personnel of high oil temperature, and complete installation.	4. Operation Procedures – pg. 17	
			5. Handling Precautions – pg. 34	
Orientation				
1	Operational Descriptions	Explain unit operation as written in instruction manual.	1. Safety Precautions ~ 13. List of Hazardous Substances pgs. 1~44	
2	Error code	Explain function of each component as written in instruction manual.	8. Troubleshooting ~ 9. Service & Repair – pgs. 38~40	
3	Maintenance & Inspection	Explain of inspection and maintenance procedure as written in instruction manual.	6. Maintenance Procedures – pg. 36	
4	Installation Data Entry Completion	<ul style="list-style-type: none"> Fill in installation date and name of installing personnel or company on unit "OK and Service Sticker". Explain how to contact technician. 	9. Service & Repair – pg. 40	

Limited Liability

Always operate equipment in strict compliance to the handling and operation procedures set forth by this instruction manual.

Yamato Scientific Co., Ltd. assumes no responsibility for malfunction, damage, injury or death, resulting from negligent equipment use.

Never attempt to disassemble, repair or perform any procedure on BM/BO units which are not expressly mandated by this manual. Doing so may result in equipment malfunction, serious personal injury or death.

Note

- ◆ Instruction manual descriptions and specifications are subject to change without notice.
- ◆ Yamato Scientific Co., Ltd. will replace flawed instruction manuals (pages missing, pages out of order, etc.) upon request.

Instruction Manual

**Water Bath
Model BM401**

and

**Oil Bath
Model BO601**

First Edition May 12, 2014

Revised

Yamato Scientific America, Inc.

925 Walsh Avenue, Santa Clara,
CA 95050, U.S.A

<http://www.yamato-usa.com>

Toll Free: 1-800-2-YAMATO (1-800-292-6286)

International: 1-408-235-7725