

VACUUM CONTROLLER

VACUU·SELECT® Complete controller (lab scaffold version)

VACUU·SELECT® Complete controller (built-in version)

VACUU·SELECT® Complete controller (benchtop version)



Instructions for use



Original instructions Keep for further use!

This manual is only to be used and distributed in its complete and original form. It is strictly the user's responsibility to carefully check the validity of this manual with respect to the product.

Manufacturer:

VACUUBRAND GMBH + CO KG
Alfred-Zippe-Str. 4
97877 Wertheim
GERMANY

Phone:

Head office +49 9342 808-0
Sales +49 9342 808-5550
Service +49 9342 808-5660

Fax: +49 9342 808-5555

Email: info@vacuubrand.com

Web: www.vacuubrand.com

*Thank you for purchasing this product from **VACUUBRAND GMBH + CO KG**. You have chosen a modern and technically high quality product.*

TABLE OF CONTENTS

1	Introduction	7
1.1	User information	7
1.2	Manual structure	8
1.3	About this document	9
1.3.1	Display conventions	9
1.3.2	Symbols and icons	10
1.3.3	Handling instructions (action steps)	11
1.3.4	Abbreviations	12
1.3.5	Term definitions	13
2	Safety information	14
2.1	Usage	14
2.1.1	Intended use	14
2.1.2	Improper use	15
2.1.3	Foreseeable misuse	15
2.2	Target group description	16
2.2.1	Personnel qualification	16
2.2.2	Responsibility matrix	16
2.2.3	Personal responsibility	17
2.3	Safety precautions	17
2.3.1	Safety precautions, general	17
2.3.2	Awareness of potential dangers	18
2.3.3	ATEX equipment category (sensor)	19
2.4	Disposal	20
3	Product description	21
3.1	VACUU·SELECT Complete	21
3.2	Product views	23
3.2.1	VACUU·SELECT Complete (schematic design)	23
3.2.2	VACUU·SELECT Sensor	26
3.2.3	Chemically resistant in-line solenoid valve	27
3.3	VACUU·BUS peripheral devices (option)	28
3.4	Example	29
3.5	Remote control and interfaces	30
3.5.1	RS-232 serial interface	30
3.5.2	Modbus TCP	30
4	Installation and connection	31
4.1	Transport	31
4.2	Installation	31
4.2.1	Benchtop version	32
4.2.2	Lab scaffold version	32

4.2.3	Built-in version	35
4.3	Electrical connection	37
4.4	Vacuum connection	39
4.5	Venting connection (option)	41
5	User interface	42
5.1	Switch on controller	42
5.1.1	Touchscreen	43
5.1.2	Gestures for operation	43
5.2	Set up device	43
5.2.1	Data storage message	43
5.3	Screen orientation	44
5.4	Display and operating elements	45
5.4.1	Process screen (main screen)	45
5.4.2	Display elements	46
5.4.3	Operating elements and symbols	48
6	Operation	52
6.1	Applications	52
6.1.1	Select and start application	52
6.1.2	Adjust pressure setpoint	53
6.1.3	Vent	55
6.1.4	Stop application	56
6.2	Application parameters (parameter list)	56
6.3	Pressure graph	58
6.4	Main menu	59
6.4.1	Applications	60
6.4.2	Favorites	61
7	Main menu	62
7.1	Advanced operation	62
7.1.1	Application editor	62
7.1.2	Menu bar and description	63
7.1.3	Overview of process steps	64
7.1.4	Process end	65
7.1.5	Edit application	66
7.1.6	Remove process step	68
7.1.7	Settings	69
7.1.8	Settings/administration	71
7.1.9	Administration – import/export	73
7.1.10	Administration – VACUU·BUS	74
7.2	Data logger	77
7.3	Service	78
7.3.1	Service information	78
7.3.2	Diagnostic data	79

8	Troubleshooting	80
8.1	Error messages	80
8.1.1	Error indication	80
8.1.2	Acknowledge error indication	81
8.2	Error – Cause – Remedy	81
8.2.1	Pop-up message	81
8.2.2	General faults	82
8.3	Device fuse.	84
9	Appendix	86
9.1	Technical information	86
9.1.1	Technical data.	86
9.1.2	Rating plate.	89
9.1.3	Wetted materials.	89
9.1.4	Vacuum data.	90
9.2	Ordering information.	91
9.3	Licensing information and data protection	92
9.4	Service	93
9.5	Index.	94
9.6	EC Declaration of conformity	96
9.7	UKCA Declaration of Conformity	97
9.8	CU Certificate.	98

1 Introduction

This manual is part of your product.

1.1 User information

Safety

Instructions for use
and safety

- Read this manual thoroughly and completely before using the product.
- Keep this manual in an easily accessible location.
- Correct use of the product is essential for safe operation. Comply with all safety information provided!
- In addition to this manual, adhere to the accident prevention regulations and industrial safety regulations applicable in the country of use.

General

General
information

- For easier readability, the general term *controller* is used as an equivalent to and instead of the product name **VACUU-SELECT Complete**.
- If passing the product on to a third party, also give them this manual.
- The illustrations in this manual are only intended to facilitate comprehension.
- We reserve the right to make technical and design changes in the course of continuous product improvement.

Copyright

Copyright © and
copyright law

The content of this manual is protected by copyright. Only copies for internal use are allowed, e.g., for professional training.

© VACUUBRAND GMBH + CO KG

Contact

- Contact us
- If your manual is incomplete, you can request a replacement. Alternatively, you can use our download portal: www.vacuubrand.com
 - When contacting our Service Department, please have the serial number and product type at hand → see *Rating plate on the product*.
 - You are welcome to contact us at any time in writing or by telephone if you would like more information, have questions about our products or wish to share feedback with us.

1.2 Manual structure

Modular instructions
for use

The manuals have a modular structure with separate instruction modules for the controller, vacuum pumps, pumping units, and any accessories.

Instruction modules

→ Example
Breakdown of the
instructions for use

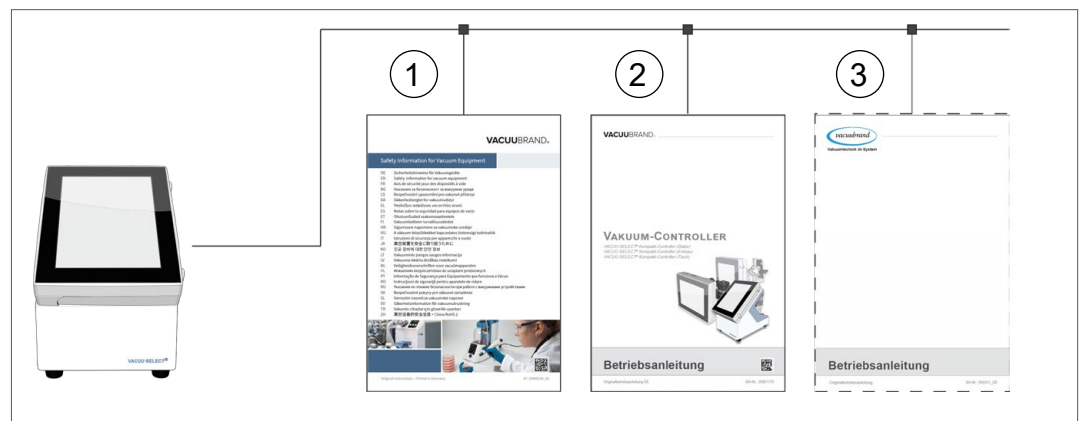

- 1 Safety information for vacuum equipment
- 2 Description: Vacuum controller – control and operation
- 3 Optional description: vacuum pump, accessories, etc.

1.3 About this document

1.3.1 Display conventions

Warning levels

Display conventions

	DANGER
	<p>Indicates an imminent hazardous situation. Disregarding the situation could result in extremely serious injury or death.</p> <p>⇒ Take appropriate action to avoid dangerous situations!</p>

	WARNING
	<p>Warns of a potentially hazardous situation. Disregarding the situation could result in serious injury or death.</p> <p>⇒ Take appropriate action to avoid dangerous situations!</p>

	CAUTION
	<p>Indicates a potentially hazardous situation. Disregarding the situation could result in minor injury or damage to property.</p> <p>⇒ Take appropriate action to avoid dangerous situations!</p>

NOTE	
<p>Indicates a potentially harmful situation. Disregarding the situation could result in damage to property.</p>	

Additional notes

IMPORTANT!

- ⇒ Information or specific recommendation which must be observed.
- ⇒ Important information for trouble-free operation of your product.



- ⇒ Helpful tips + tricks
- ⇒ Additional information

1.3.2 Symbols and icons

This manual uses symbols and icons. Safety symbols indicate specific risks associated with handling the product. Symbols and icons are designed to help you identify risks more easily.

Safety symbols

Explanation of safety symbols



General warning symbol.



Danger: electricity.



Warning: hot surface.



General prohibition sign.



General mandatory sign.



Disconnect power plug.



Electrostatically sensitive components ESD.



Cadmium free

Additional symbols and icons

Additional symbols



Positive example – **Do this!**
Result – **OK**



Negative example –
Don't do this!



Refers to content in this manual.



Refers to content in other supplementary documents.



Acoustic signal – signal sound/warning sound.



Frequency of beeping, frequency of acoustic signal

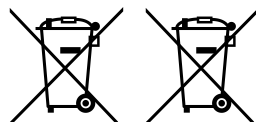

Electric/electronic devices and batteries must not be disposed of in the domestic waste at the end of their service life.



Flow arrow
Vacuum

Symbols and gestures for operation

→ See chapter: **5.1.2 Gestures for operation on page 43**



⇒ Additional detailed descriptions of symbols (icons) and signals on the display can be found in chapter **5.4 Display and operating elements**.

1.3.3 Handling instructions (action steps)

Action steps as text

Instructions (single step)

⇒ Perform the step described.

Result of action

Instructions (multiple steps)

1. First step

2. Next step

Result of action

Perform the steps in the order described.

Instructions (shown graphically)

Schematic diagram
Action steps as graphics

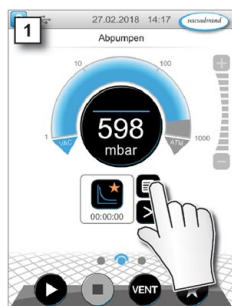

1. First step

2. Next step

Result of action

1.3.4 Abbreviations

Abbreviations

abs.	Absolute
AK	Separator flask
ATM	Atmospheric pressure (bar graph, program)
d_i (di)	Interior diameter
DN	Nominal diameter
EX*	Outlet
FKM	Fluoroelastomer
GB	Gas ballast
hh:mm:ss	Time in hours/minutes/seconds
hPa	Pressure unit, hectopascal (1 hPa = 1 mbar = 0.75 Torr)
IN*	Inlet
KF	Small flange
max.	Maximum value
min.	Minimum value
mbar	Pressure unit, millibar (1 mbar = 1 hPa = 0.75 Torr)
PA	Polyamide
PBT	Polybutylene terephthalate
PC	Pumping unit chemistry with type identification number
PE	Polyethylene
RMA no.	Return Merchandise Authorization number
SW	Wrench size (tool)
Torr	Pressure unit (1 Torr = 1.33 mbar = 1.33 hPa)
USB	Universal serial bus
VAC	Vacuum (pressure curve)
resp.	Responsible
VMS-B	Vacuum management system – module
e.g.	For example

* Labeling on the vacuum pump

1.3.5 Term definitions

Product-specific terms

Fine vacuum	Pressure measuring range in vacuum systems, from: 1 mbar-0.001 mbar (0.75 Torr–0.00075 Torr)
Rough vacuum	Pressure measuring range in vacuum systems, from: atmospheric pressure–1 mbar (atmospheric pressure–0.75 Torr)
VACUU·BUS	Bus system from VACUUBRAND for communication between peripheral devices with VACUU·BUS -enabled gauges and controllers. The maximum admissible cable length is 30 m.
VACUU·BUS address	Address which enables the VACUU·BUS client to be unambiguously assigned within the bus system, e.g., for connecting multiple sensors with the same measurement range.
VACUU·BUS client	Peripheral device or component with VACUU·BUS port, which is integrated in the bus system, e.g., sensors, valves, level indicators, etc.
VACUU·BUS configuration	Assigning a different VACUU·BUS address to a VACUU·BUS component using a gauge or controller.
VACUU·BUS connector	4-pin round connector for the bus system from VACUUBRAND .
VACUU·SELECT	Vacuum controller, controller with touchscreen; consisting of operating panel and vacuum sensor.
VACUU·SELECT Complete	Vacuum controller in two-point version for existing vacuum sources such as individual pumps or powerful local area vacuum networks
VACUU·SELECT Sensor *	External vacuum sensor ▶ for VACUU·SELECT or ▶ separately as an independent vacuum sensor.

* Available with or without venting valve

2 Safety information

The information in this chapter must be observed by everyone who works with the product described here.

The safety information is valid for the entire life cycle of the product.

2.1 Usage

Only use the product if it is in perfect working condition.

2.1.1 Intended use

Intended use The *VACUU-SELECT Complete* is a lab instrument intended to regulate absolute pressure in the area of rough and fine vacuum for existing vacuum sources such as individual pumps or powerful local area vacuum networks.

The device may only be used indoors in a non-explosive atmosphere. It is designed for continuous operation between 10 °C–40 °C.

Intended use also includes:



- observing the information in the document Safety information for vacuum equipment,
- observing the manual,
- observing the manual of connected components,
- using only approved accessories or spare parts.

Any other use is considered improper use.

2.1.2 Improper use

Improper use Incorrect use or any application which does not correspond to the technical data may result in injury or damage to property.

Improper use includes:

- using the product contrary to its intended use,
- operation under inadmissible environmental and operating conditions,
- vacuum control of potentially explosive atmospheres which does not correspond to the ATEX authorization of the sensor → see *sensor rating plate*,
- operation despite obvious faults or defective safety devices,
- usage despite incomplete assembly,
- pulling plug-in connections on the cable out of the socket,
- use in mines or underground.

2.1.3 Foreseeable misuse

Possible
foreseeable misuse

In addition to improper use, there are types of use which are prohibited when handling the device:



- installation and operation in potentially explosive atmospheres,
- unauthorized extensions or conversions, in particular when these impair safety,
- fully exposing the device to the vacuum, immersing it in liquids, exposing it to water spray or steam jets,
- vacuum control of hot, unstable, or explosive media,
- operation with sharp-edged objects,
- switching the device on/off with tools or one's foot,
- operating the controller by remote control without knowledge of the connected vacuum system.

2.2 Target group description

IMPORTANT!

Users in the areas of competence in the *Responsibility matrix* must possess the relevant qualifications for the activities listed.

2.2.1 Personnel qualification

Meaning of personnel qualifications

Operator	Laboratory staff, such as chemists, laboratory technicians
Specialist	Person with professional qualification in mechanics, electrical equipment or laboratory devices
Responsible specialist	Similar to a specialist, with additional specialist responsibility, or responsibility for a department or division

2.2.2 Responsibility matrix

Responsibility matrix and areas of competence

Activity	Operator	Specialist	Responsible specialist
Installation	x	x	x
Commissioning	x	x	x
Network integration			x
Updates		x	x
Data import/export		x	x
Data logger download	x	x	x
Troubleshooting	x	x	x
Operation	x	x	x
Advanced operation		x	x
Error report	x	x	x
Remedy	(x)	x	x
Changing circuit board fuse		x	x
Repair order			x
Cleaning, simple	x	x	x
Sensor cleaning*		x	x
Sensor calibration*		x	x
Shutdown	x	x	x
Decontamination**		x	x

* Option

** Alternatively, arrange for decontamination by a qualified service provider

2.2.3 Personal responsibility

Work safely

The safety and protection of individuals has top priority. Activities and processes which represent a potential safety hazard are not permitted.

Always be conscious of safety and work in a safe manner. Observe instructions issued by the operator, and national regulations on accident prevention and industrial safety.

⇒ Use the controller only if you have understood its function and this manual.

Protective clothing

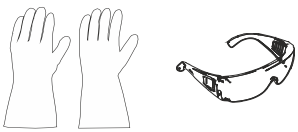

⇒ In the case of activities which require protective clothing, personal protective equipment as specified by the operator is to be worn.

2.3 Safety precautions

Quality standards
and
safety

Products from **VACUUBRAND GMBH + CO KG** are subject to stringent quality testing with regard to safety and operation. Each product undergoes a comprehensive test program prior to delivery.

2.3.1 Safety precautions, general

⇒ When handling contaminated parts, follow the relevant regulations and safety precautions.

⇒ Repairs are only to be carried out by the manufacturer's Service Department.

IMPORTANT!

Prior to any service, contamination from hazardous substances needs to be excluded.

⇒ Please note that residual process media may pose a danger to people and the environment. Take suitable decontamination measures.

⇒ Before sending devices to our Service Department, you must first fill out a [Health and Safety Clearance](#) form, sign it to confirm the information, and return it to us.

2.3.2 Awareness of potential dangers

Vacuum control of critical processes

Risk of explosion during critical processes

	DANGER
	<p>Risk of explosion through control of critical processes.</p> <p>Depending on the process, an explosive mixture can form in systems.</p> <p>⇒ The control of critical processes must always be supervised!</p>

Damaged components

IMPORTANT!

Damaged components, especially those which impair safety, must be promptly replaced.

- ⇒ Ensure that you are not working with damaged components.
- ⇒ Replace defective parts immediately, e.g., a broken cable or faulty plug.

Dangers due to electrical energy

Electrical energy

After the controller has been switched off and disconnected from the power supply, there may still be dangers at the plug-in power supply due to residual energy:

- ⇒ Replace the plug-in power supply if there are any defects.
- ⇒ Never open the plug-in power supply.

Service shipments

Safety during servicing

Devices which represent a potential safety hazard should be sent in, maintained or repaired only if all hazardous contamination has been removed.



- ⇒ The form for confirming safety is available as a PDF on our website: [Health and Safety Clearance form](#).

2.3.3 ATEX equipment category (sensor)

Installation and potentially explosive atmospheres



Installation and operation in areas where potentially explosive atmospheres can develop to a hazardous degree is not permitted.

ATEX approval only applies if applicable to the **internal wetted parts of the device**, not to its surroundings.

ATEX equipment labeling

ATEX-
equipment category



Vacuum equipment labeled with  has ATEX approval in line with the ATEX marking on the rating plate.

- ⇒ Only use the product if it is in perfect working condition.
- ⇒ The devices are designed for a low level of mechanical stress and must be installed in such a way that they cannot sustain mechanical damage from the outside.
- ⇒ After any work on the device, check its leak rate.

ATEX
approval

When using the device on equipment with potentially explosive atmospheres (according to ATEX approval), modifications to the device are not permitted and will invalidate the ATEX approval. Wetted parts attached to the device must have ATEX approval at least equivalent to that of the device itself, and must not adversely affect the ATEX approval of the device, in particular the temperature in the wetted area.

Prevent explosive
mixtures

The use of gas ballast and/or venting valves is only permitted if this would not normally, or only rarely, cause explosive mixtures within the device, or do so only for a short time.

- ⇒ If necessary vent with inert gas.

Information on the ATEX equipment category is also available on our website at: www.vacuubrand.com/.../Information-ATEX

Explanation of
usage conditions X
Example extract
type plate

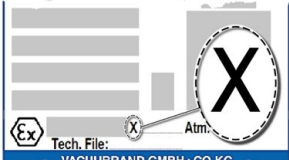

Restrictions on operating conditions

Meaning for devices marked with X:

- The devices have a low mechanical protection and must be installed so that they cannot be mechanically damaged from the outside; e.g., installing pump stations with impact protection, attaching shatter protection for glass flasks, etc.
- The devices are designed for an ambient and media temperature of +10 °C to +40 °C during operation. These ambient and media temperatures must never be exceeded. When conveying/measuring non-explosive gases, extended gas suction temperatures apply, see chapter: Technical information, media temperature (gas).

2.4 Disposal

NOTE

Electronic components and batteries must not be disposed of in the domestic waste at the end of their service life.

Used electronic devices and batteries contain harmful substances that can cause damage to the environment or human health. Disused electrical devices also contain valuable raw materials, which can be recovered for reuse if the device is disposed of correctly within the recycling process.

End users are legally obliged to take used electric and electronic devices to a licensed collection point and to return spent batteries.

- ⇒ It is your responsibility to save and delete any data before disposing of your electronic device.
- ⇒ If the device contains batteries: Remove spent batteries before disposal.
- ⇒ Correctly dispose of all electronic scrap and electric components at the end of their service life.
- ⇒ Observe the national regulations regarding disposal and environmental protection.

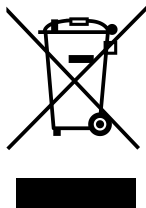

<https://www.vacuubrand.com/20901491>

3 Product description

3.1 VACUU-SELECT Complete

Description of vacuum controller

The *VACUU-SELECT Complete* is a fully equipped two-point vacuum controller for existing vacuum sources such as individual pumps or powerful local area vacuum networks.

The controller comprises the *VACUU-SELECT* vacuum controller with integrated ceramic vacuum sensor and venting valve, a non-return valve and a chemically resistant in-line solenoid valve.

Simply connect the controller between the vacuum pump and the application.

The controller is available as a benchtop device, for lab scaffold mounting, or as a built-in version for lab workstations.

Controller versions



The controller was developed for applications which require a controlled vacuum. Various applications and menus are available for operation and vacuum control. The controller is operated using the touchscreen. The menus are designed to be user friendly. Depending on the type of operation and peripheral devices connected, the controller regulates the process vacuum subject to demand. In the case of solvent evaporation, it detects boiling pressure automatically and switches to two-point control mode.

As a component of the *VACUU-BUS* system, the controller offers numerous connection options for a wide variety of applications.

Vacuum processes are controlled via in-line solenoid valves and/or venting valves. If several valves of one type are connected, they switch simultaneously, e.g., multiple venting valves.



To control a vacuum, a minimum combination of the controller, a vacuum sensor, valves and/or vacuum pumps is needed.

If only the built-in sensor is present, vacuum control is not possible.

3.2 Product views

3.2.1 VACUU-SELECT Complete (schematic design)

The controller has a color display with touchscreen. Depending on the type of installation, the display can be rotated by 90°.

All controller versions have the same connections, as described here in the example for the lab scaffold version.

Side view + front

→ Example
Side view and front
view
Lab scaffold version

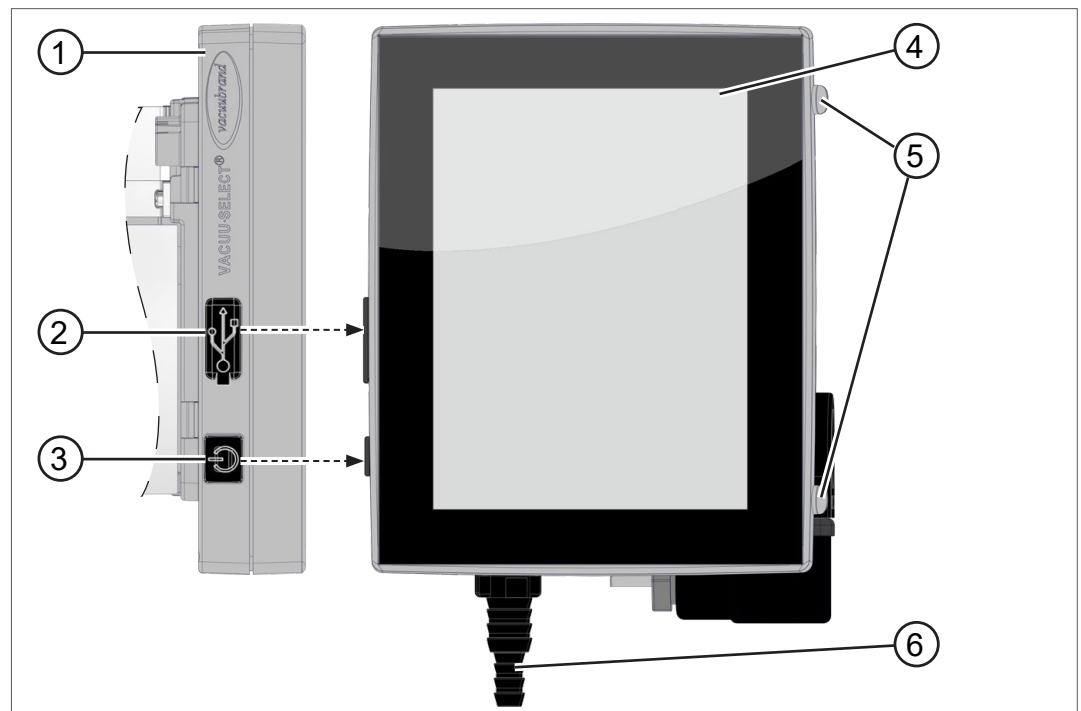

Meaning

1	Chemically resistant plastic housing
2	Cover of USB port, type A*
3	ON/OFF button
4	Screen
5	Rubber feet
6	Vacuum connection (here: hose nozzle)



USB type A* is only suitable for connecting USB flash drives or WiFi USB dongles, and not for connection to a USB master, such as a PC.

Rear view

→ Example
Back and interfaces,
lab scaffold version

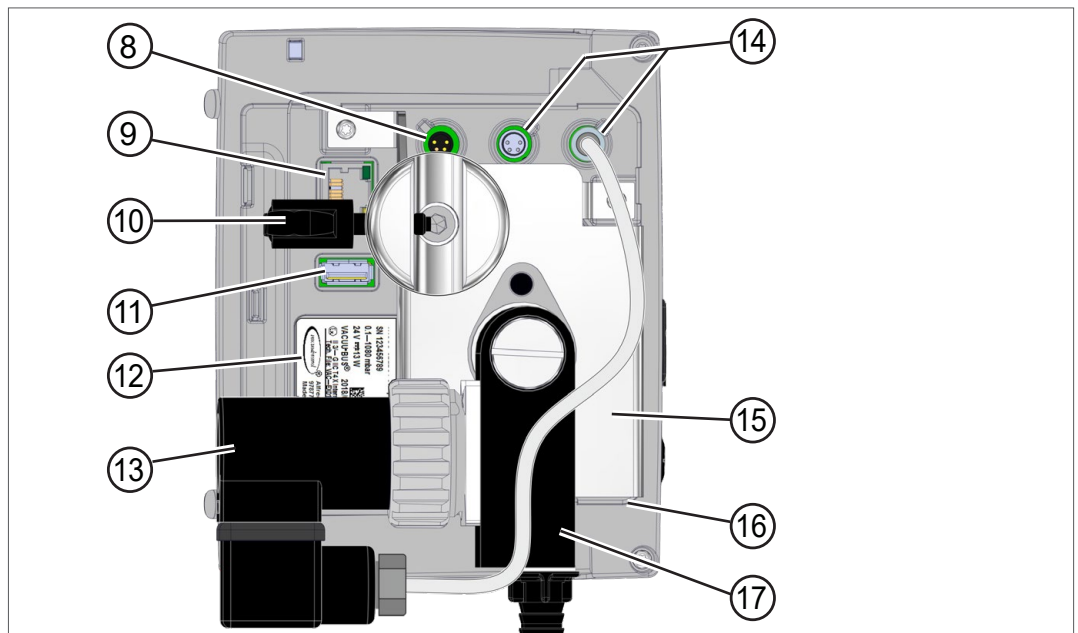

Meaning

8	Power supply via VACUU-BUS plug-in power supply
9	RJ45 socket – LAN connection
10	Stand holder with wing nut
11	USB port, type A
12	Rating plate
13	Chemically resistant in-line solenoid valve
14	Connection sockets for VACUU-BUS components
15	Stand panel
16	VACUU-SELECT Sensor
17	Valve block with connections

Note: The VACUU-BUS ports are each equipped with a guide slot as an anti-rotation device and connection coding for VACUU-BUS sockets and connectors.

IMPORTANT!

⇒ Do not use the USB ports as distributors, except for USB hubs with their own power supply.

Top view

→ Example
Plan view, lab
scaffold version

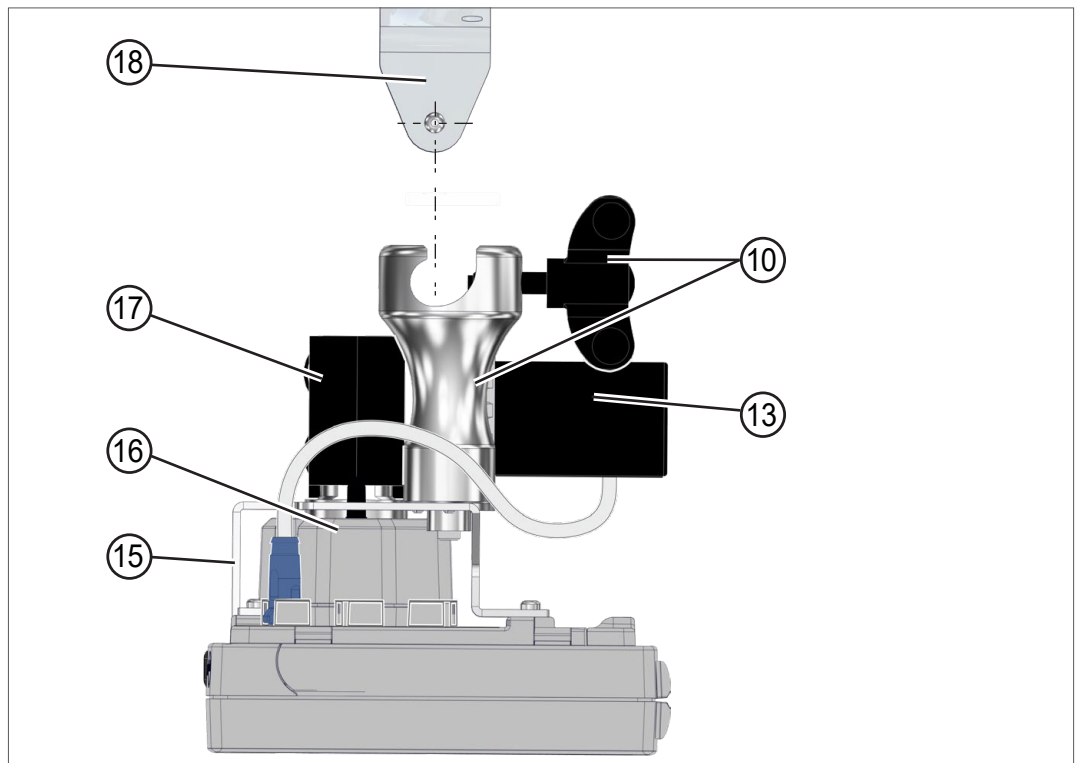

Meaning

- | | |
|-----------|---|
| 10 | Stand holder with wing nut |
| 13 | Chemically resistant in-line solenoid valve |
| 15 | Stand panel |
| 16 | VACUU-SELECT Sensor |
| 17 | Valve block with connections |
| 18 | Wall bracket (option) |

3.2.2 VACUU-SELECT Sensor

Description of
VACUU-SELECT
Sensor

The vacuum sensor is mounted on the **VACUU-SELECT Complete**. Communication with the controller takes place via the **VACUU-BUS**.

Two versions of the **VACUU-SELECT Sensor** are available – with or without venting valve.

The vacuum sensor with high chemical resistance is designed for measurements in the rough vacuum range. Vacuum connection is carried out via the valve block.

Side view, plan view

→ Example
Views of
VACUU-SELECT
Sensor

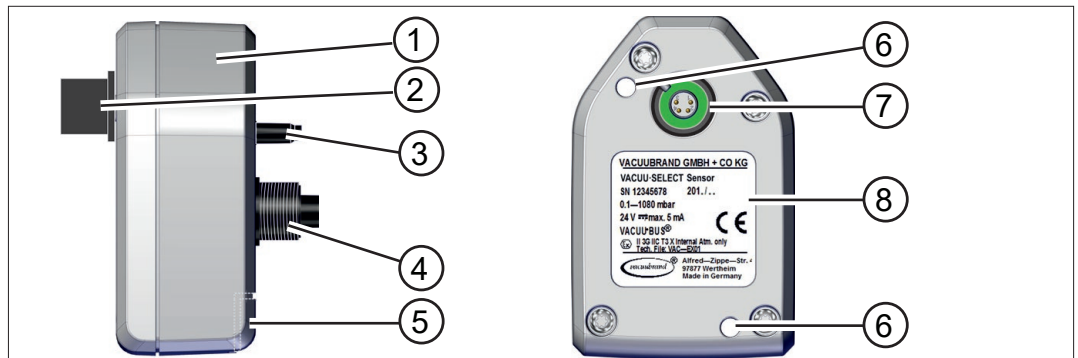

Meaning

- | | |
|---|---|
| 1 | VACUU-SELECT Sensor |
| 2 | VACUU-BUS plug attachment, detachable (option) |
| 3 | Venting valve (option) |
| 4 | Vacuum screw connection |
| 5 | Port for VACUU-BUS plug attachment (park position) |
| 6 | Hole for screws |
| 7 | VACUU-BUS port |
| 8 | Rating plate |

3.2.3 Chemically resistant in-line solenoid valve

The fitted chemically resistant in-line solenoid valve comprises an electromagnetic drive and valve block, and is used as a vacuum regulating valve. A built-in non-return valve prevents this from affecting nearby applications on one vacuum supply.

Depending on the controller version, hose nozzles or screw-in connectors are available to connect the vacuum pump and application.

Side view, plan view

→ Example Views
Chemistry resistant in-line solenoid valve

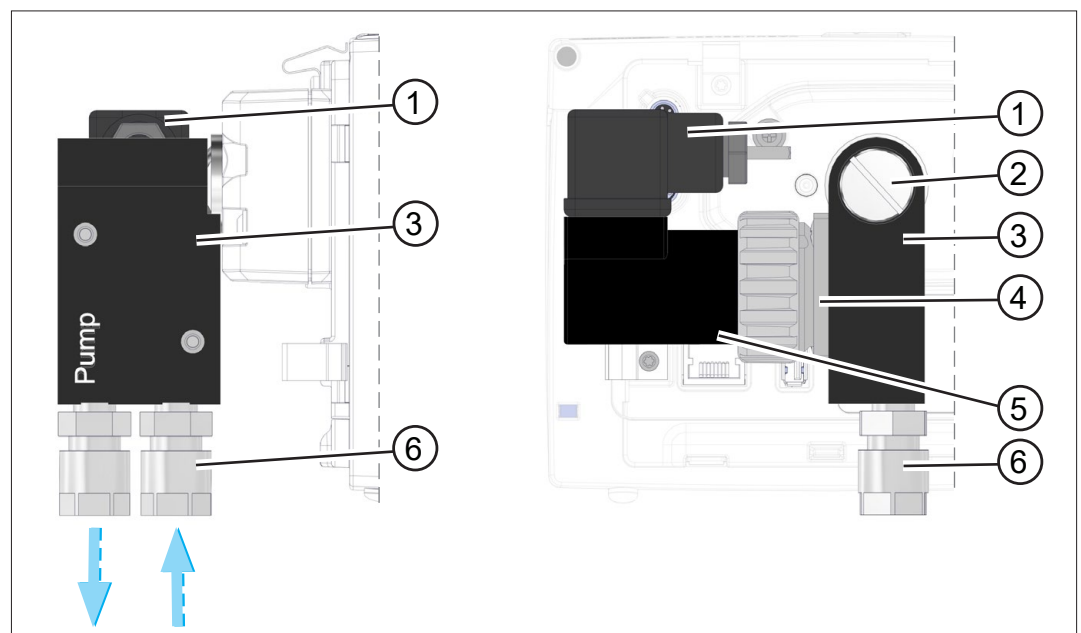

Meaning

1	Valve connector
2	Cheese head screw M6 x 10
3	Valve block
4	Internal: non-return valve
5	Electromagnetic drive
6	Vacuum connections: pump, application



In the built-in version, the complete valve block can be pivoted 90°, as can the stand holder in the lab scaffold version.

This means the controller can be used either horizontally or vertically.

3.3 VACUU·BUS peripheral devices (option)

VACUU·BUS
principle

External valves, level sensors and vacuum sensors (up to the fine vacuum range) are components that can be connected via VACUU·BUS directly to the controller.

VACUU·BUS components can be easily added or removed at any time via component detection. Component activation permits the activation or deactivation of connected components.

VACUU BUS components1 (clients)

When the controller is switched on, it checks the current configuration. VACUU·BUS components are automatically detected and are used and monitored until the controller is switched off. If a previously connected component is no longer found, the controller displays an error message.



In the case of the *VACUU SELECT Complete*, all *VACUU BUS* components can be individually activated or deactivated without disconnecting the plug. The venting valve of a *VACUU SELECT Sensor* can also be easily deactivated at the controller.

→ See also chapter: *7.1.10 Administration – VACUU·BUS*

3.4 Example

Local area vacuum network

→ Example
Local area vacuum
network with rotary
evaporation

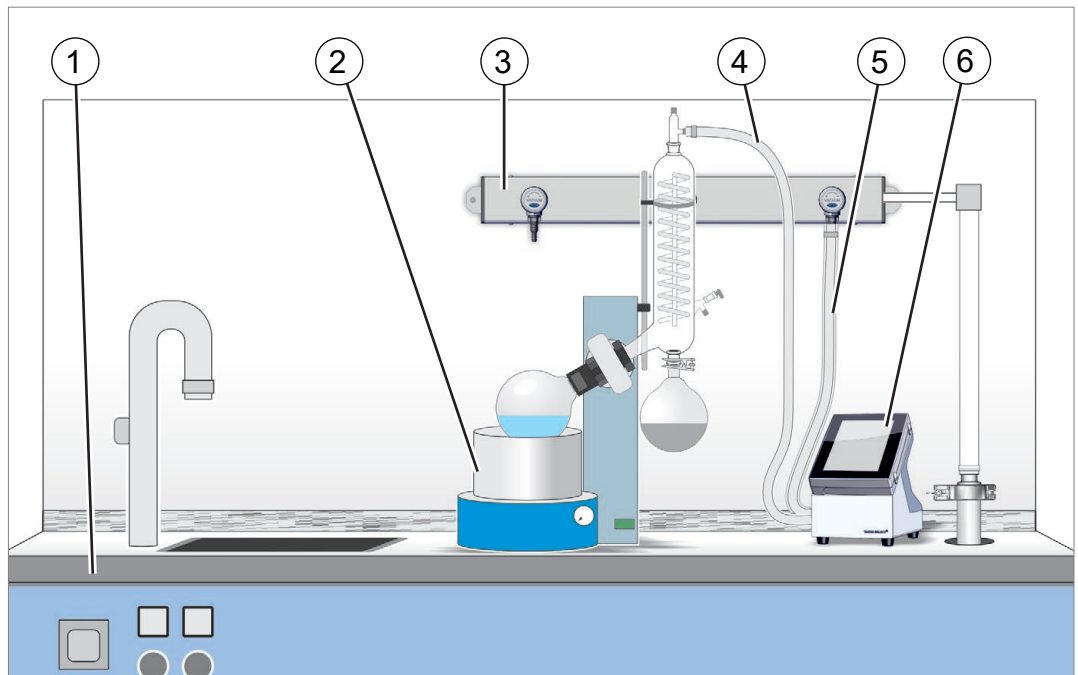

Meaning

- | | |
|---|--|
| 1 | Lab furniture |
| 2 | Example: rotary evaporator |
| 3 | VACUU·LAN – local area vacuum network with three valve modules |
| 4 | Vacuum hose for application |
| 5 | Vacuum hose from vacuum pump/local area vacuum network |
| 6 | VACUU·SELECT Complete |

3.5 Remote control and interfaces

As of Softwareversion V1.04/V1.00 of the **VACUU-SELECT**, communication will be supported via RS-232 as well as Modbus TCP. This enables you to remotely monitor and control the controller from a central location, for example with a PC or process control system. For connections → see chapter: **3.2.1 VACUU-SELECT Complete (schematic design)**

3.5.1 RS-232 serial interface

An RS-232 USB adapter can be connected to one of the USB ports of the controller, to act as a serial interface.

→ Example
RS-232 connection

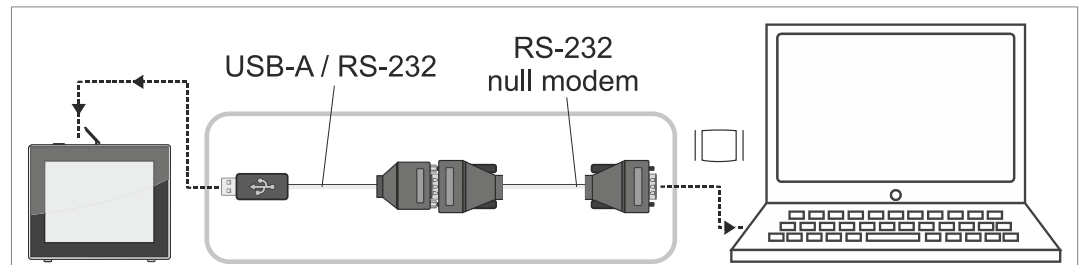

Required accessories

Adapter cable, USB to RS-232, 1 m	20637838
RS-232C null modem cable, 2x socket Sub-D 9-pin, 1.5 m	20637837

3.5.2 Modbus TCP

For remote control via Modbus TCP, use the Ethernet connection RJ45 on the back of the controller.

→ Example
Ethernet connection

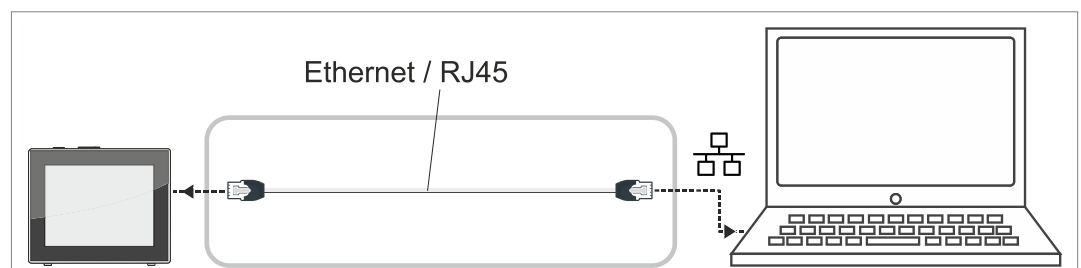

Detailed descriptions of the interfaces can be found here: [Interface instructions for use](#).

4 Installation and connection

4.1 Transport

Products from **VACUUBRAND** are packed in sturdy, recyclable packaging.



The original packaging is accurately matched to your product for safe transport.

- ⇒ If possible, please keep the original packaging, e.g., for returning the product for repair.

Goods receipt

Check incoming goods

Check the shipment for transport damage and completeness.

- ⇒ Immediately report any transport damage in writing to the supplier.

- ⇒ Compare the scope of delivery with the delivery note.

4.2 Installation

Check installation conditions

Check installation conditions

- The device is acclimatized.
- Ambient conditions have been observed and are within the limitation of use.

Limitation of use		(US)
Ambient temperature	10-40 °C	50-104 °F
Max. altitude	2000 m above sea level	6562 ft above sea level
Relative humidity	30-80 %, non-condensing	
Protection class (front)	IP 42/IK 06	
Prevent condensation or contamination from dust, liquids, or corrosive gases.		

IMPORTANT!

- ⇒ Note the IP protection class of the controller.

- ⇒ IP protection is only guaranteed if the controller is appropriately mounted or installed.

NOTE**Condensate can damage the electronics.**

A large temperature difference between the storage location and the installation location can cause condensation.

⇒ After goods receipt or storage, allow your vacuum device to acclimatize for at least 3-4 hours before initial use.

4.2.1 Benchtop version

Use as benchtop device

As a benchtop version, the controller can be set up directly on the work surface and connected, for example on the lab bench.



4.2.2 Lab scaffold version

Use as lab scaffold device

With the lab scaffold version, a stand holder is fitted to the back of the controller. The stand holder enables the controller to be attached directly to a scaffold bench in the lab or mounted on the wall using the wall bracket.

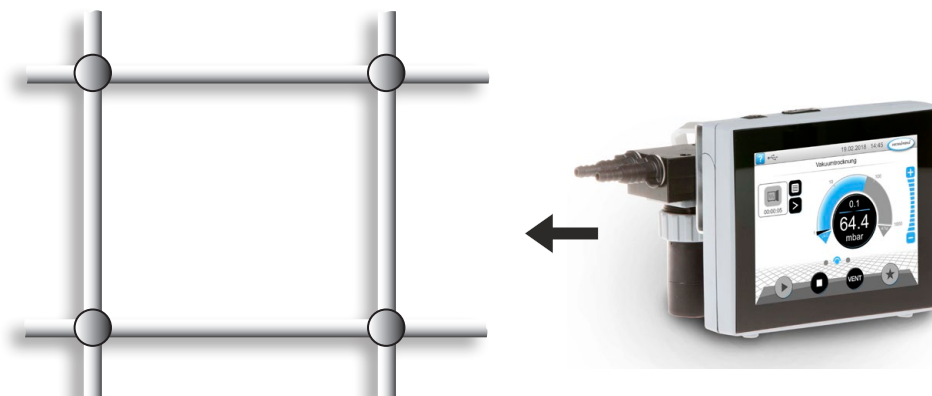

Mount the wall bracket

Mount the wall bracket

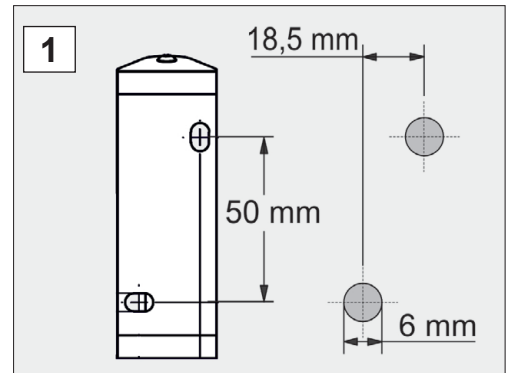

Preparation:

⇒ Have the tool and fittings ready; e.g., impact drill, masonry drill Ø6 mm, wall plugs size 6, universal screws, min. 5x30, screwdriver.

1. Use the drilling template to mark the dimensions on the surface where the wall bracket should be mounted.

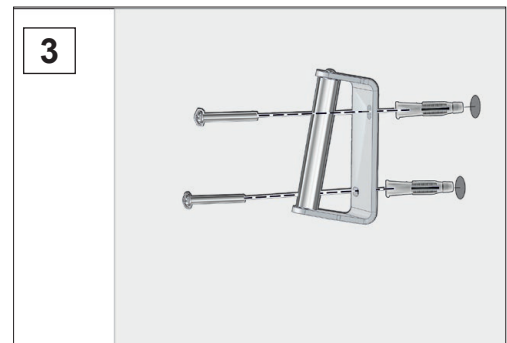
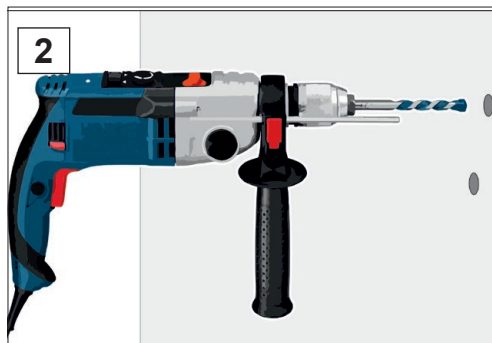

2. Drill 2 holes in the wall and remove the debris.

3. Insert the rawl plugs and then secure the wall bracket using the screws.

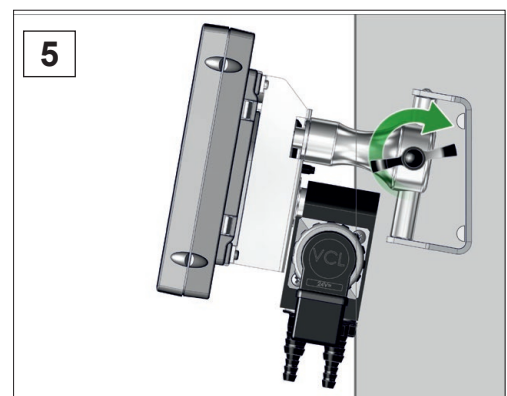
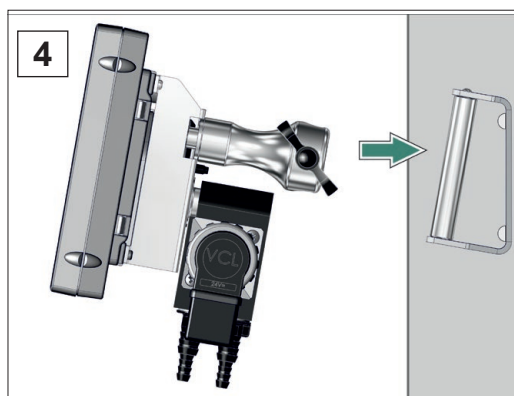

4. Mount the controller with the stand holder.

5. Secure the controller with the wing nut.

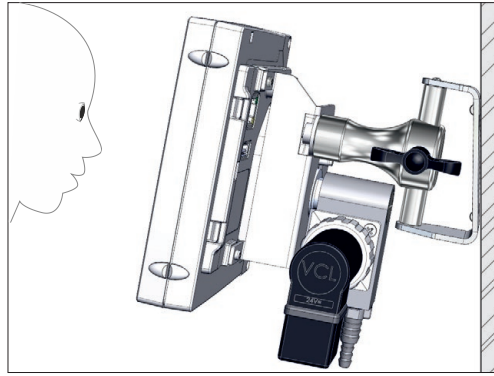

☑ Mounted wall bracket with controller.

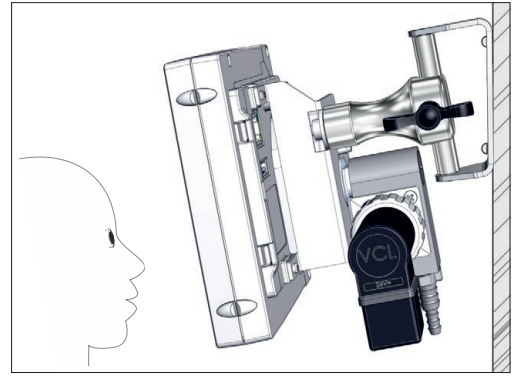

Alternatively, the wall bracket can be mounted so that it is pivoted at an angle.

Pivot stand holder

Pivot stand holder
90°

To use the controller horizontally, the stand holder can be pivoted 90° at the back.

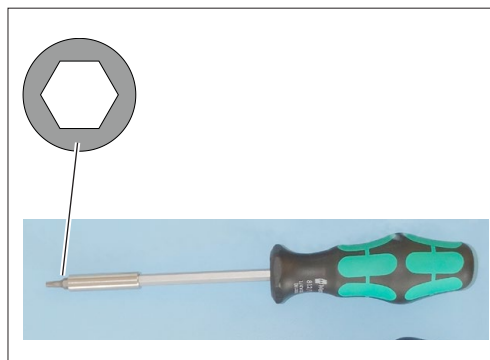

Preparation:

⇒ Have the tool ready;
Hex key size 5.

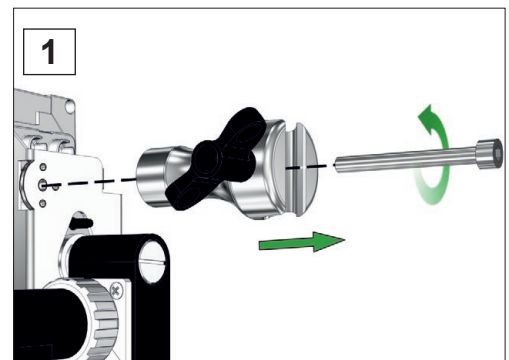

1. First open the wing nut and then unscrew the hexagon socket screw.

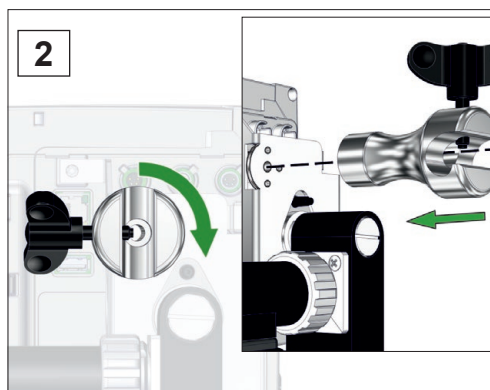

2. Pivot the stand holder 90° and push the stand holder with the locating pins into the corresponding holes.

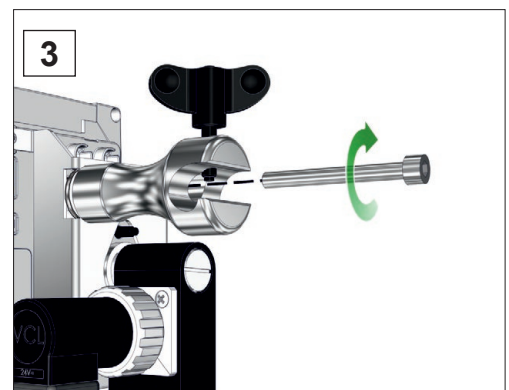

3. Screw in the hexagon socket screw, then hand-tighten the wing nut.

4.2.3 Built-in version

Use as built-in device

In the built-in version, spring clips are fitted on the back of the controller. This means the controller can be clipped directly into the installation cut-out of lab furniture or a control cabinet. The display can be pivoted so that the controller can be clipped into place either horizontally or vertically.

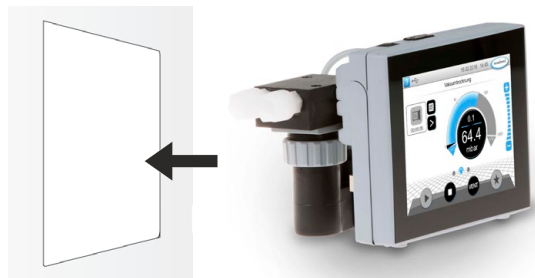

Installation cut-out

Cut-out dimensions (in control cabinet, lab furniture, cable duct)

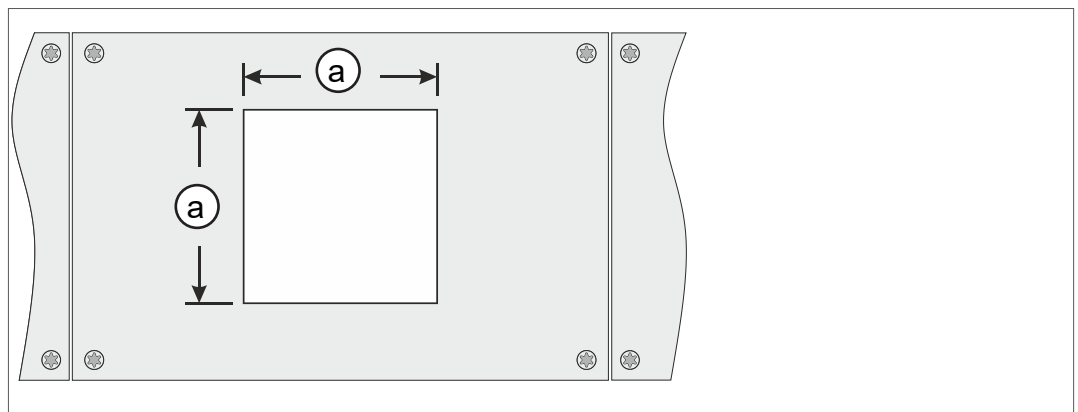

Wall thickness		Dimensions (a) for installation cut-out	
1 mm	0.04 in.	111.5 mm x 111.5 mm	4.39 in. x 4.39 in.
2 mm	0.08 in.	112 mm x 112 mm	4.41 in. x 4.41 in.
3 mm	0.12 in.	112.5 mm x 112.5 mm	4.43 in. x 4.43 in.

Depending on the thickness of the wall, appropriate tolerances should be allowed for the installation cut-out.

Spring clips + screw fittings D3 x 10 20636593

Pivot valve block

Depending on the installed orientation, the valve block can be pivoted 90°, e.g., for better access and connection of the hoses.

Pivot valve block of the built-in version 90°

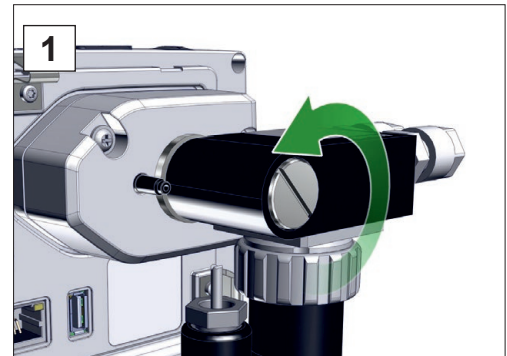

Preparation:

⇒ Have the tool ready; flat-head screwdriver size 6 (alternatively, a suitable coin).

1. Turn the fastening screw half a turn to the left.

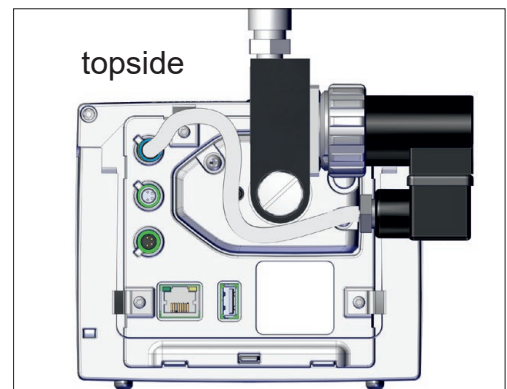
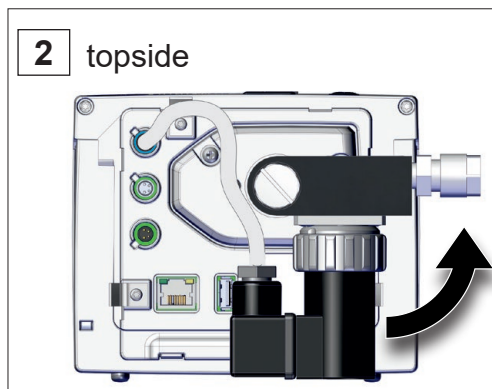

2. Pivot the valve block 90°.

Pivoted valve block.

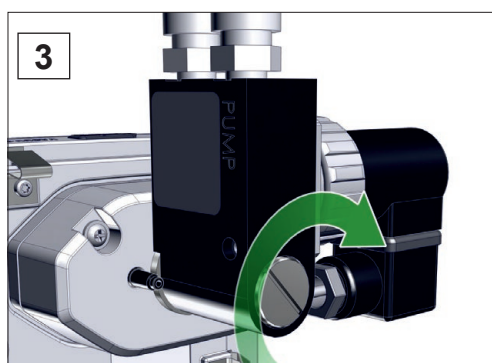

3. Tighten the fastening screw.

4.3 Electrical connection

IMPORTANT!

⇒ Lay the connection cable such that it cannot be damaged by sharp edges, chemicals, or hot surfaces.

NOTICE

The CE/UKCA mark and a cTÜVus mark (see rating plate) may be voided if not using a VACUUBRAND power supply.

- ⇒ Use a VACUUBRAND wall power supply plug to provide the supply voltage.
- ⇒ If the supply voltage is not provided by VACUUBRAND wall power supply plug, the power supply must provide a stabilized 24 V DC voltage which must not provide more than 6.25 A even in case of failure.
- ⇒ If using additional overcurrent protection devices (e. g., fuses), these protection devices must interrupt the supply voltage at a maximum current of 8.4 A after 120 s at the latest.

Power supply via plug-in power supply*

Plug-in power supply

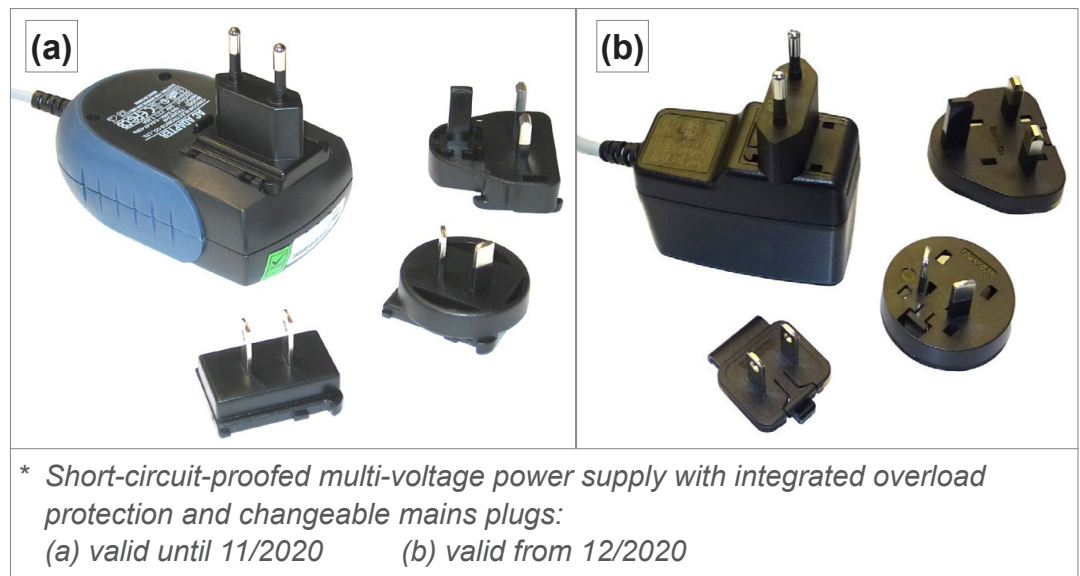

Prepare wall power supply plug

Prepare connection

1. Take the wall power supply kit out of the packaging.
2. Select the mains plug that fits to your mains socket.
3. Connect the mains plug to the metal contacts of the wall power supply plug.
4. Slide the mains plug until it locks.

Remove mains plug

Remove plug attachment from power supply unit

1. Press the locking knob on top of the wall power supply plug.
2. Remove the mains plug.

Another mains plug can be fixed.

Connect plug-in power supply to the controller

⇒ Insert the **VACUU BUS** cable of the plug-in power supply into the plug-in connection of the controller.

Power supply via plug-in power supply

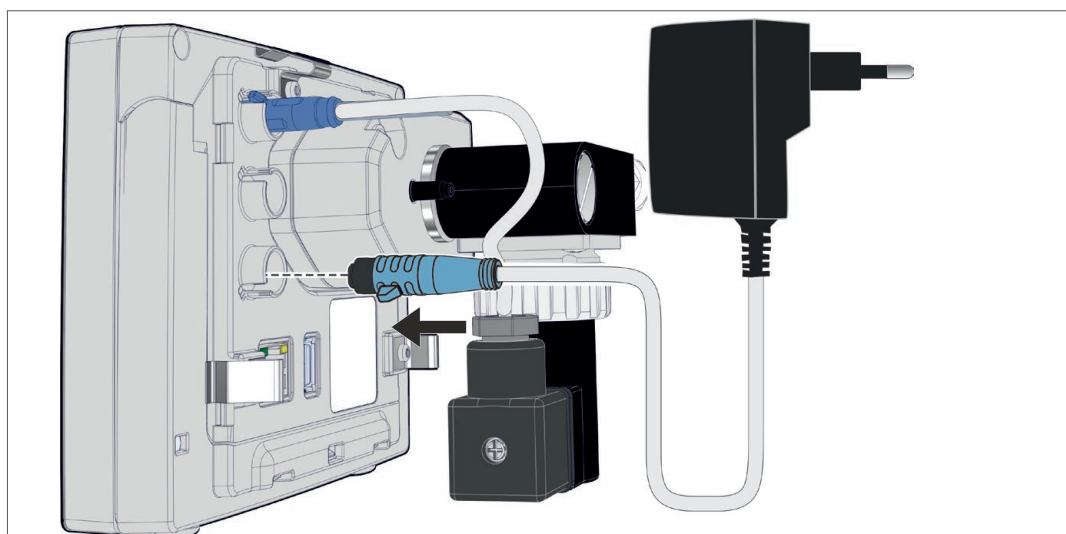

Connect power supply

⇒ Insert the plug-in power supply into the power outlet.

4.4 Vacuum connection

	WARNING
	<p>Risk of bursting due to overpressure</p> <p>⇒ Prevent uncontrolled overpressure, such as when connecting to a locked or blocked tubing system.</p>

Vacuum connection is carried out at the back of the controller, at the chemically resistant in-line solenoid valve. Various connection options are available depending on the controller version. Hose material is not part of the standard delivery.

Connection options

Controller version and connection options

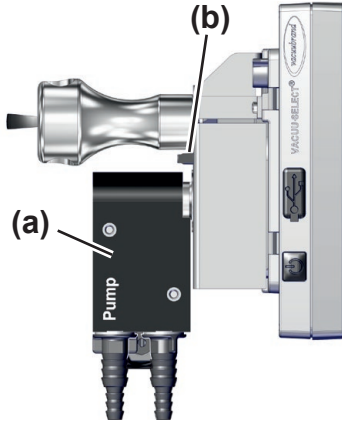
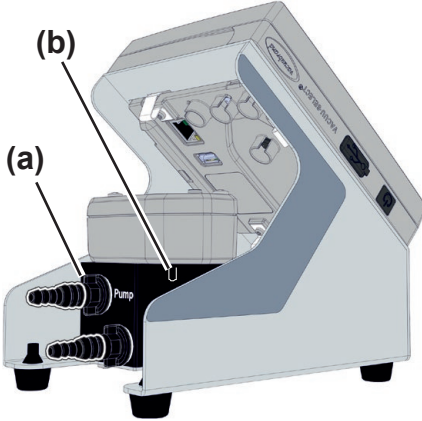
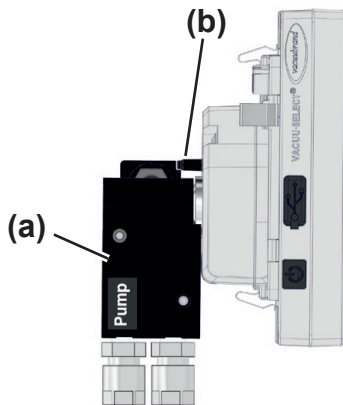
	
Connection via hose nozzle DN 6/10	
	<p>(a) chemically resistant in-line solenoid valve</p> <p>(b) Venting valve on sensor</p>
Connection via PTFE hose DN 8/10	

IMPORTANT!

- ⇒ Use a stable vacuum hose that is suitable for the required vacuum range.
- ⇒ Dirt, hose kinks or damage can impair function.

Connect PTFE hose

Required connection material: PTFE hose.

Vacuum connection
PTFE

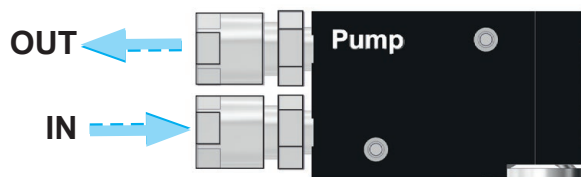

OUT Connect vacuum pump or VACUU·LAN.
IN Connect application

<p>1</p>	<p>1. Unscrew the union nuts and slide them on to the hoses.</p>
<p>2</p>	<p>2. Insert the hoses into the screw-in connector and secure them with the union nuts.</p>

Connect hose to hose nozzle

Required connection material: vacuum hose and suitable hose clip.

Vacuum connection,
hose nozzle

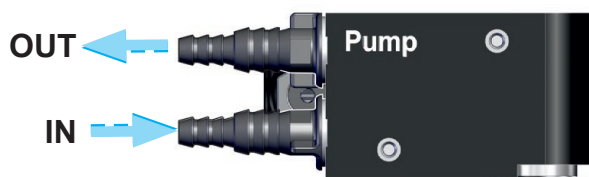

OUT Connect vacuum pump or VACUU·LAN.
IN Connect application

<p>1</p>	<p>1. Push the vacuum hoses on to the hose nozzles.</p>
<p>2</p>	<p>2. Secure the vacuum hoses with hose clips.</p>

4.5 Venting connection (option)



DANGER

Risk of explosion by venting with air.

Depending on the application, venting can cause explosive mixtures to form or other hazardous situations to arise.

- ⇒ Never vent processes with air which could form an explosive mixture.
- ⇒ If necessary, vent with inert gas (max. 1.2 bar/900 Torr, abs.).

Venting gas is connected at the back of the controller, at the hose nozzle of the **VACUU·SELECT Sensor**. The sensor is installed in different ways depending on the controller version. Hose material is not part of the standard delivery.

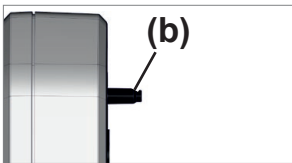

Venting with ambient air¹

For venting **(b)** with ambient air, nothing needs to be connected to the sensor.

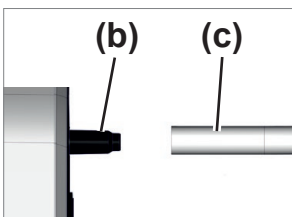

Venting with inert gas – connect venting valve¹

Required connection material: Hose for hose nozzle, e.g., silicone tube 4/5 mm

⇒ Attach the hose **(c)** to the connection of the venting valve **(b)**.

- Venting valve with hose for venting with inert gas².

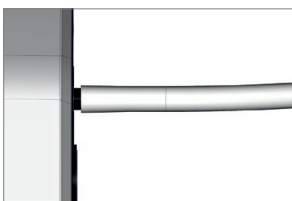

¹ Only applicable to sensors *with* an integrated venting valve.
² Avoid overpressure.

5 User interface

5.1 Switch on controller

Switch on device

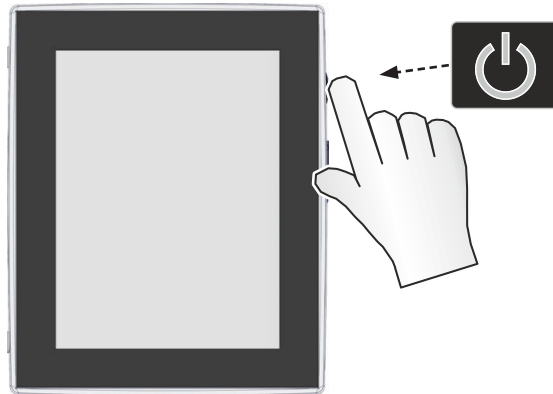

⇒ Briefly press the ON/OFF button on the controller



☑ The device starts up



☑ Information is displayed

Functions of the ON/OFF button

ON/OFF button

ON/OFF	Meaning
	Switch on controller ▶ Briefly press ON/OFF button.
	Switch off controller ▶ Hold down ON/OFF button for ~3 seconds and confirm pop-up.
	Lock/unlock controller ▶ Briefly press ON/OFF button. ▶ Lock device against unintended operation, e.g., when cleaning the display.
	Controller restart (reboot) ▶ Hold down ON/OFF button for ~10 seconds.

5.1.1 Touchscreen

Touchscreen operation

The controller is a device operated via touchscreen. You can, for example, select, start, and stop an application by tapping the display.

By making various gestures, you can access advanced features: switch between views, edit applications, or use the help and context features.

5.1.2 Gestures for operation

Gesture symbols

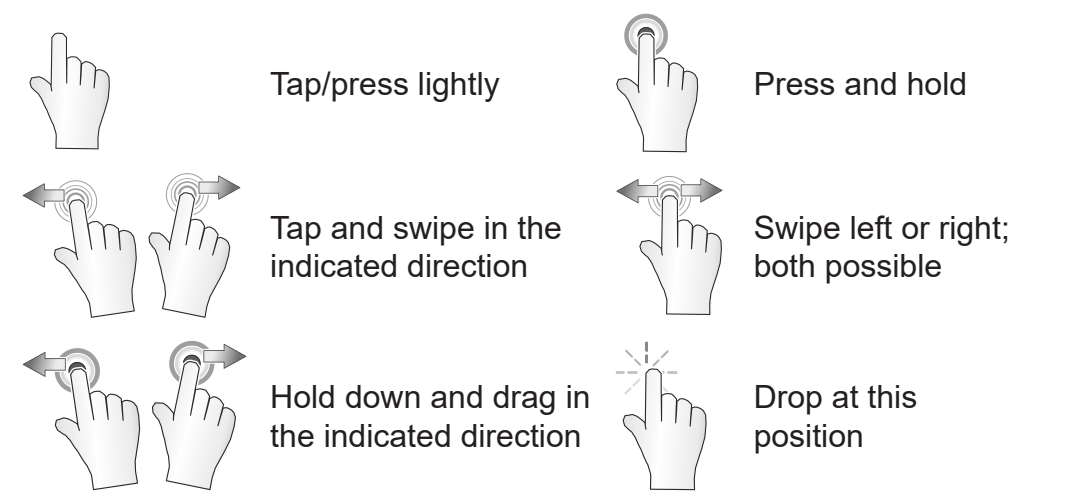

5.2 Set up device

To set up the device, follow the instructions on the screen when switching the device on for the first time or after restoring the factory settings.

5.2.1 Data storage message

Before the controller switches to the process screen, a pop-up window opens with information on current data storage.

→ Example
Info pop-up on data storage

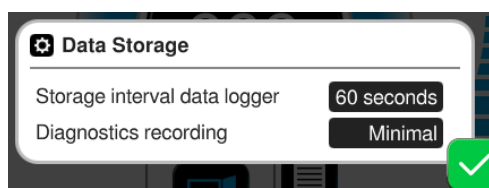

Data storage

- ▶ Data logger storage interval
- ▶ Diagnostics recording

⇒ Select your preferred settings and confirm the message.

In the delivered condition or following a reset to the factory settings, the data logger is switched off and recording of diagnostic data is preset to *Minimal*.

The message about data storage appears after every controller restart.

For subsequent adjustments to the data logger

→ *See chapter: 7.2 Data logger on page 77*

For subsequent adjustments to the diagnostic data

→ *See chapter: 7.3 Service on page 78*

5.3 Screen orientation

Supported screen orientations

→ Example
Landscape and
portrait view

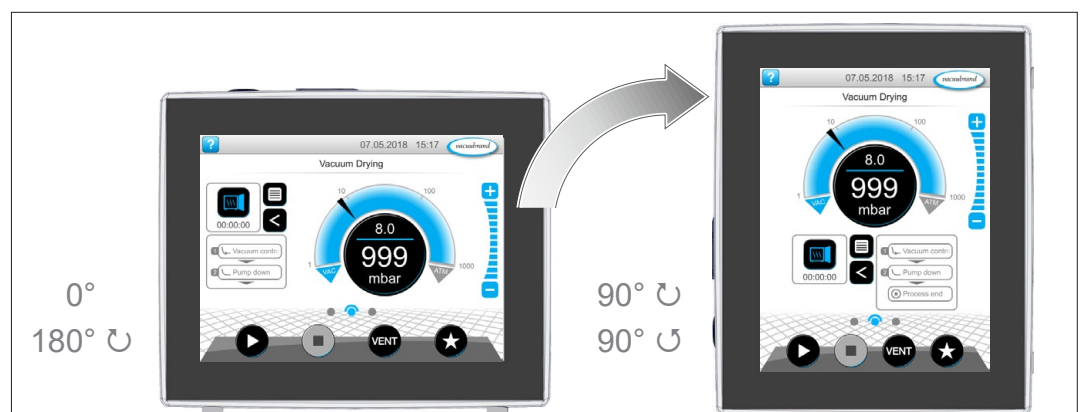

IMPORTANT!

The following descriptions for operation and function are described in vertical format (portrait). The descriptions are also valid for horizontal format (landscape), even though the operating elements may be arranged slightly differently.

Change the screen orientation

→ *See chapter: 7.1.7 Settings on page 69*

5.4 Display and operating elements

The display and operating elements of the controller are summarized and explained in this chapter.



⇒ Refer to this chapter if you want to read about the meaning of a display or an operating element during operation.

5.4.1 Process screen (main screen)

After the device is switched on, the process screen appears. The process screen is the main screen of the controller. The display adapts to the selected application, e.g., by showing the name of the application, process steps, and target values.

Elements of the process screen

→ Example
Process screen
with display and
operating elements

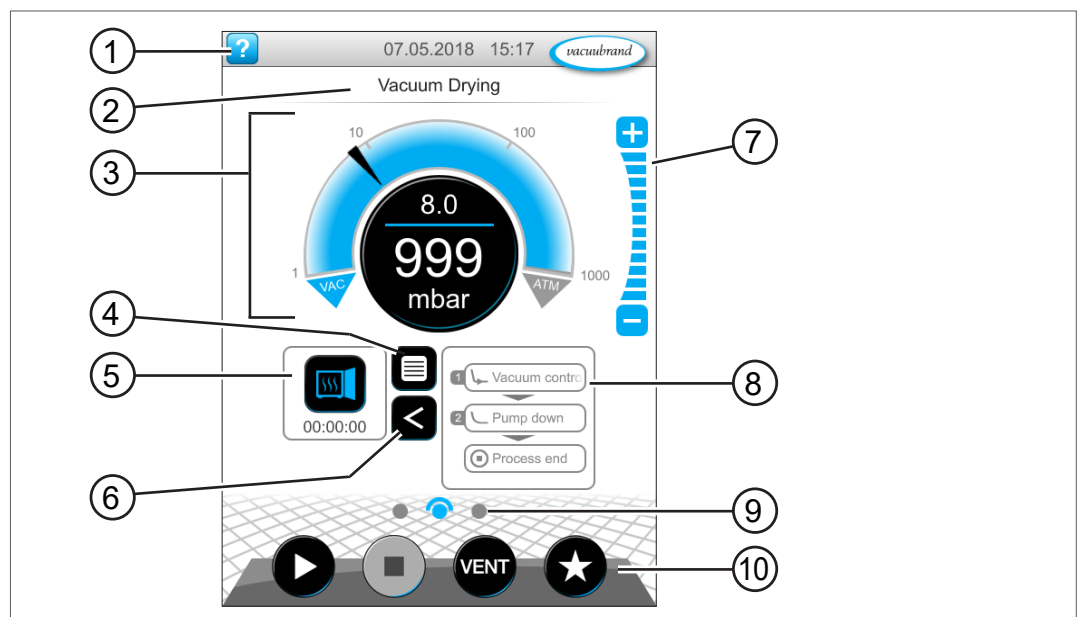

Meaning

- | | |
|----|---|
| 1 | Status bar with help button, date/time, error message |
| 2 | Title line: name of the application, display or menu |
| 3 | Analog and digital pressure display with target and actual pressure |
| 4 | Button to open the application menu |
| 5 | Application icon with process time; open parameter list |
| 6 | Open/close process step display |
| 7 | Step buttons, adjust pressure value during operation |
| 8 | Process step display |
| 9 | Screen navigation |
| 10 | Operating buttons = operating elements for control |

5.4.2 Display elements



Status bar

Status bar color codes

Color	Meaning
Gray	Standard
Yellow	Warning
Red	Error





Sounds

Sounds

Sound	Meaning
	<p><i>Touch tone unless muted</i></p> <ul style="list-style-type: none"> ▶ Feedback entry
	<p><i>Warning or error</i></p> <ul style="list-style-type: none"> ▶ Shows that an error or warning is present. ▶ Active while error status persists.

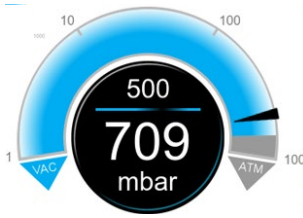
Pressure display



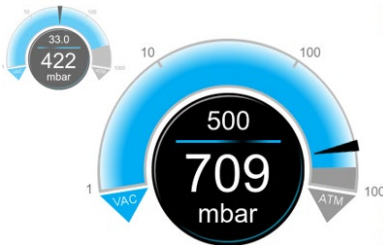

→ Example Standard pressure display

Symbol (icon)	Meaning				
	<p><i>Standard pressure display</i></p> <ul style="list-style-type: none"> ▶ Pressure curve – analog pressure display. ▶ Digital pressure display. <table border="1"> <tr> <td>Blue</td> <td>Actual pressure</td> </tr> <tr> <td>Gray</td> <td>Control range</td> </tr> </table>	Blue	Actual pressure	Gray	Control range
Blue	Actual pressure				
Gray	Control range				
	<p>Pressure setpoint</p>				
	<p>Blue dividing line – animated during operation</p>				
	<p>Actual pressure and pressure unit</p>				
	<p><i>Pressure display for 2 vacuum connections</i></p> <ul style="list-style-type: none"> ▶ Analog and digital pressure display for 2 processes. ▶ Switch between the processes by tapping the symbol. 				

→ Example Pressure display PC 520, PC 620

Pop-up windows (context menus)

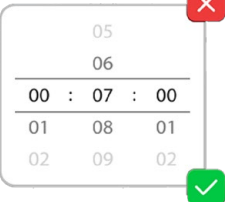
→ Examples
Pop-up window

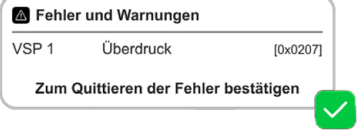
Graphic	Meaning
	<p>Numeric keypad with special buttons</p> <ul style="list-style-type: none"> ▶ Enter numerical values. ▶ Select a function using special buttons (AUS, ATM, AUTO). ▶ Min./max. values displayed. ▶ Values outside the permissible input range are not accepted.
	<p>Onscreen keyboard</p> <ul style="list-style-type: none"> ▶ Enter alphanumeric values in the input field. ▶ Automatic switching between QUERTY or QUERTZ.
	<p>Time picker</p> <ul style="list-style-type: none"> ▶ Adjust the time by scrolling through the numbers.
	<p>Pop-up list</p> <ul style="list-style-type: none"> ▶ Select a function or setting.
	<p>Message or error message</p> <ul style="list-style-type: none"> ▶ Message, error message as plain text. ▶ Confirm message, acknowledge error.

Parameter list

→ Example
Parameter list

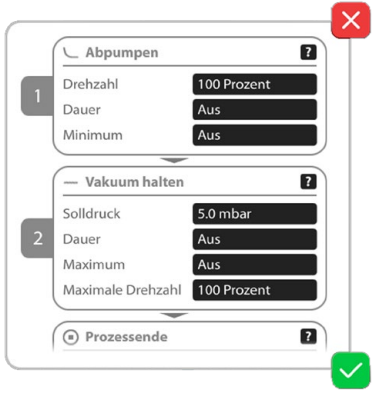





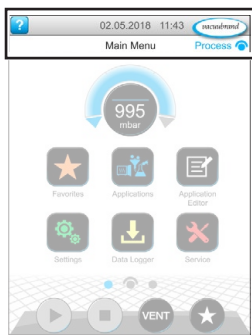

Graphic	Meaning				
	<p>Parameter list with input fields</p> <ul style="list-style-type: none"> ▶ Display and adjustment of application values. ▶ Display is divided into process steps. ▶ The parameter list display changes to reflect the selected application. <table border="1"> <tr> <td>Blue</td> <td>Active process step</td> </tr> <tr> <td>Gray</td> <td>Non-active process step</td> </tr> </table>	Blue	Active process step	Gray	Non-active process step
Blue	Active process step				
Gray	Non-active process step				

5.4.3 Operating elements and symbols

Status bar



→ Example
Main menu

Symbol (icon)	Meaning
	Access help ▶ <i>Tips for operation</i> can be accessed from any menu level.
	USB connected ▶ Shows that a device is connected via USB.
	Ethernet connected (option) ▶ Indicates that an Ethernet cable is plugged in.
	RS-232 adapter connected (option) ▶ Indicates that an RS-232 / USB converter is connected.
	WiFi active (option) ▶ Shows that a WiFi USB dongle is inserted.
	Date and time ▶ Shows the date and time in the preset format.
	View process screen ▶ Switch back to the process screen from any menu level; process screen symbol: 

Operating elements – adjust pressure setpoint

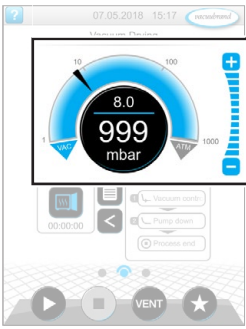

Process screen, adjust pressure setpoint, even during operation

Symbol (icon)	Meaning				
	<p>Pressure curve – analog pressure display</p> <p>▶ Adjust the pressure setpoint by moving the marker.</p>				
	<p>Marker – pressure setpoint</p>				
	<p>Digital pressure display</p> <p>▶ Adjust the pressure setpoint by tapping.</p>				
	<p>Step buttons (not a slider!)</p> <p>▶ Adjust the pressure setpoint by tapping.</p>				
	<table border="1"> <tr> <td>Blue</td> <td>Active</td> </tr> <tr> <td>Gray</td> <td>Locked</td> </tr> </table>	Blue	Active	Gray	Locked
Blue	Active				
Gray	Locked				

Operating elements – process steps

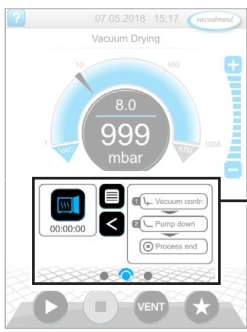

Process screen

Button or icon		Meaning
Active	Locked	Application icon ▶ Tap briefly to open the parameter list. ▶ Press and hold to open the context menu.
		Shortcut ▶ Open the applications menu.
		Right/left arrow ▶ Open/close the process step display.
		Process step display ▶ View the <i>parameter list</i> . ▶ Process step display.
		Blue Active process step during operation
		Gray Non-active process step
		Screen navigation ▶ Switch between the screens of a menu level.
		Blue Selected page
		Gray Additional pages in the level
		Continue with [text on button] (if part of the process) ▶ By tapping on the button, start the next process step shown, e.g., hold vacuum.

Operating elements – parameter list



→ Example Parameter list

Symbol (icon)	Meaning
	Cancel ▶ Cancel entry or selection. ▶ Go back to the previous display. ▶ Exit the menu.
	Help with process step ▶ Display information about the process step.
	Confirm ▶ Confirm entry or selection. ▶ Exit the menu. ▶ Acknowledge an error.

Parameter list

Txt/Num	Input field or selection field	
	▶ Tap to open a pop-up window where you can enter values or select a function, even during operation.	
	Blue	Input field for active process
	Black	Input field for inactive process

Operating elements for control

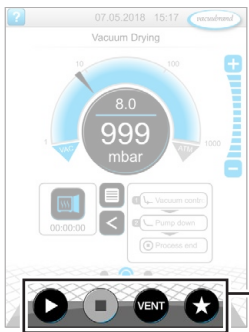

Process screen

Button		Function
Active	Locked	
		Start ▶ Start application – only available on the process screen.
		Stop ▶ Stop application – always possible.
		VENT – vent the system (option) ▶ Press button < 2 sec = vent briefly; control continues.
		▶ Press button > 2 sec = vent to atmospheric pressure; vacuum pump is stopped. ▶ Press button during venting = venting is stopped.
		Favorites ▶ View <i>Favorites</i> menu.

* Button is only displayed if venting valve is connected or activated.

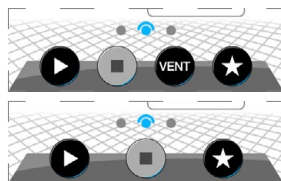

= venting valve connected and activated

= no venting valve connected or deactivated

Other icons and their functions

Icon	Meaning
	Edit ▶ Enter description for new application in application editor
	Process step configuration ▶ Adjust process step details in application editor.

6 Operation

The controller has an application-based user interface. You can select, edit and start an application from a series of pre-defined applications. Fine adjustments for the selected application can be made at any time in the parameter list or directly via the **5.4.3 Operating elements and symbols on page 48**.

6.1 Applications

6.1.1 Select and start application

→ Example
Select and start application



Tap/press lightly

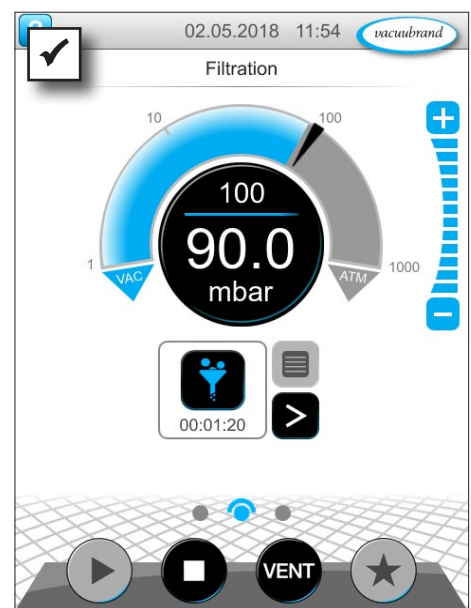
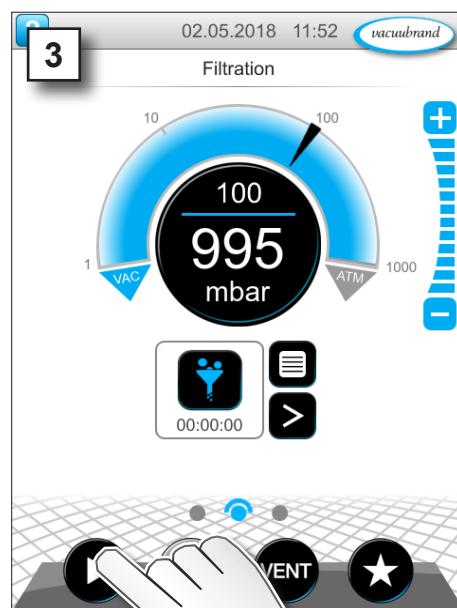
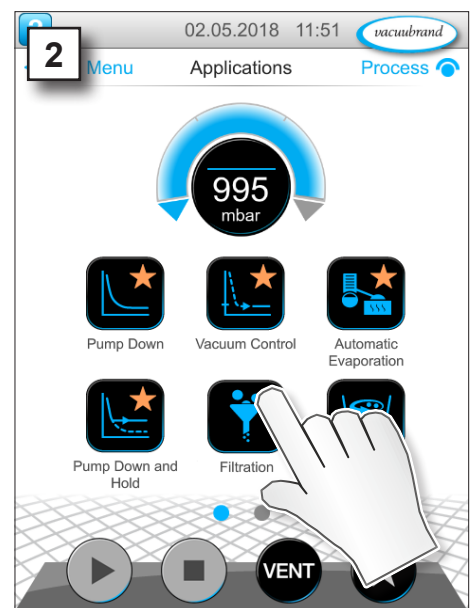
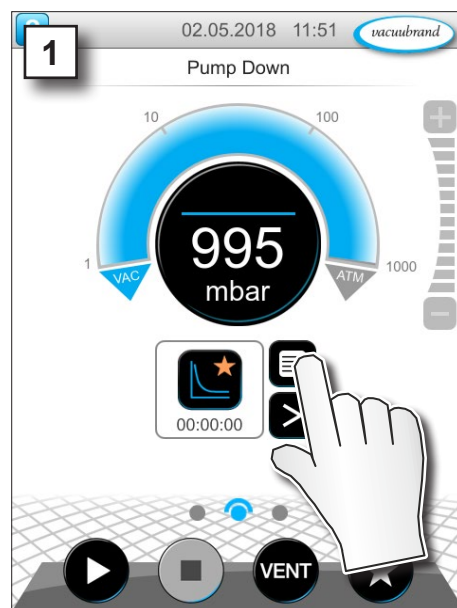

- Vacuum control running.
- Animated blue dividing line.

6.1.2 Adjust pressure setpoint

The controller offers a variety of options for adjusting the pressure setpoint during operation.

Change pressure setpoint in the parameter list



Tap/press lightly

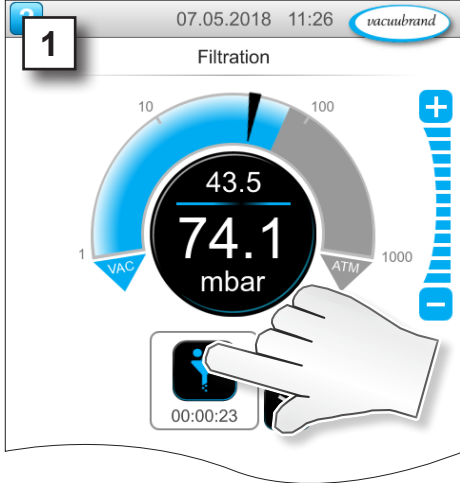

1

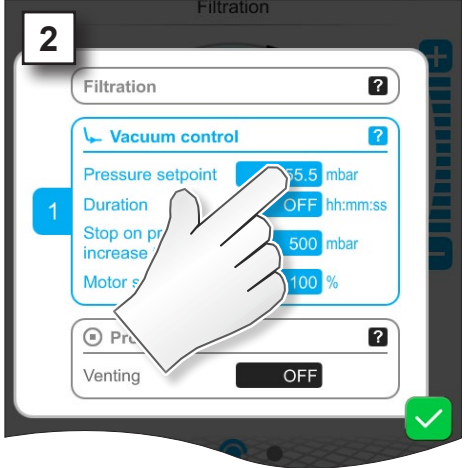

2

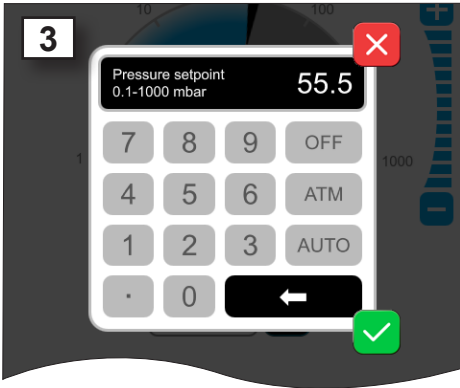

3

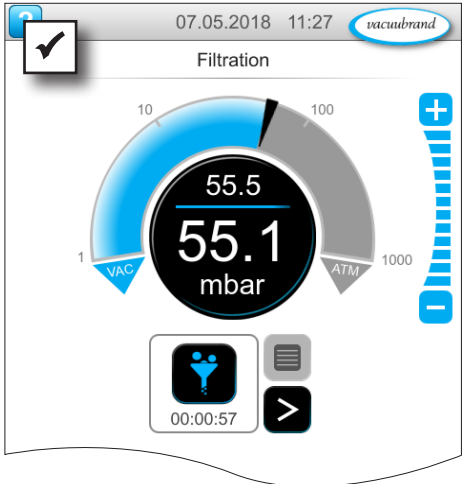



⇒ Enter a target value in the pop-up and confirm the entry 2x.

Fine adjustment via step buttons

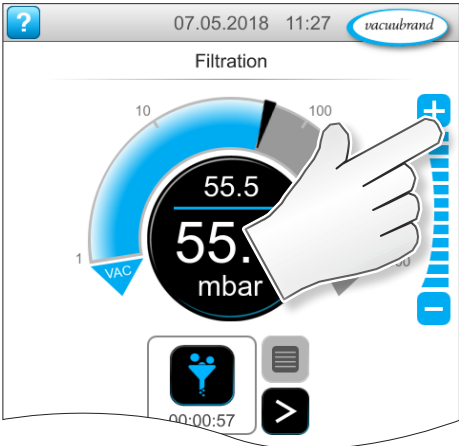

Tap/press lightly



⇒  - Tap or hold down buttons = increase target value

⇒  - Tap or hold down buttons = decrease target value

Adjust pressure setpoint using marker

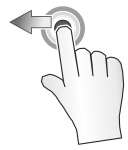

Hold down and drag



Release

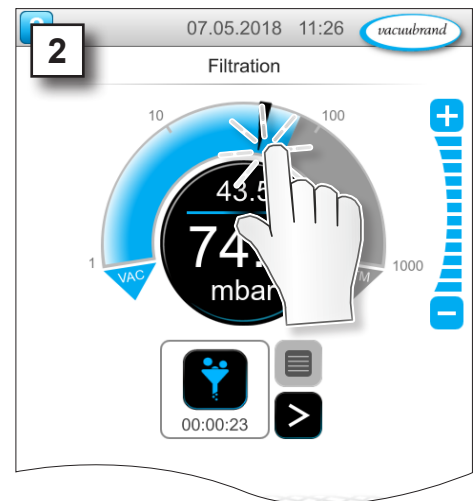
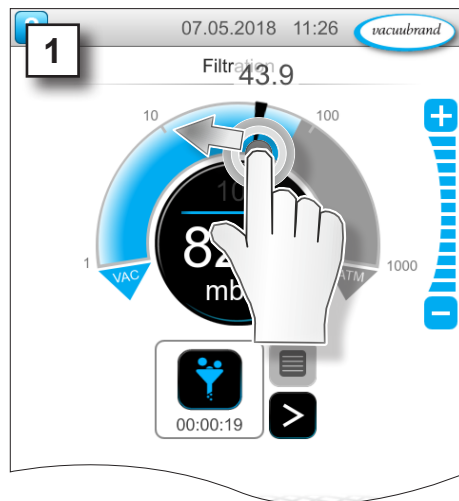

Adjust pressure setpoint in digital pressure display



Tap/press lightly

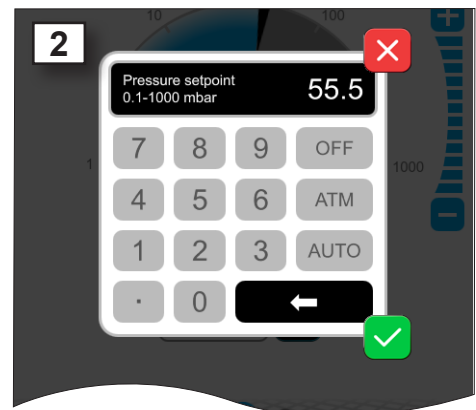
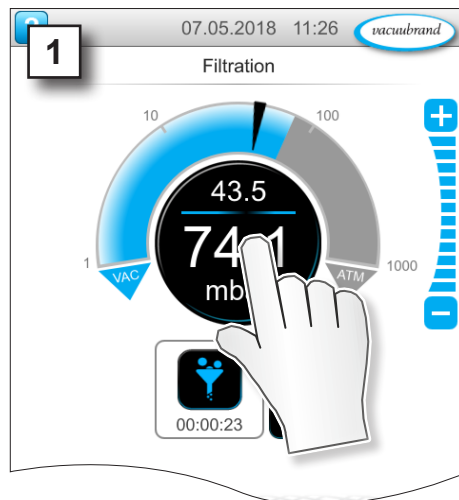

⇒ Enter a target value in the pop-up and confirm the entry.

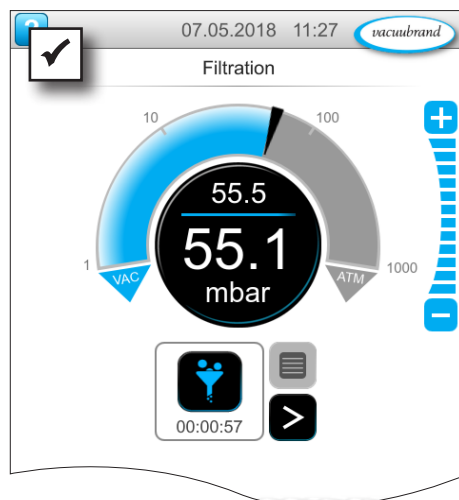

6.1.3 Vent

Vent briefly

Brief venting



Tap/press lightly

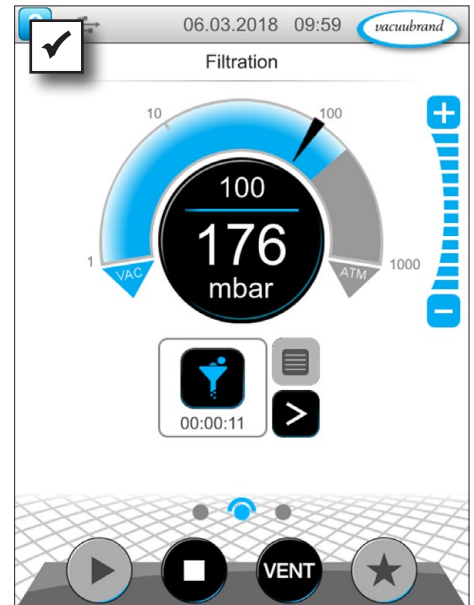
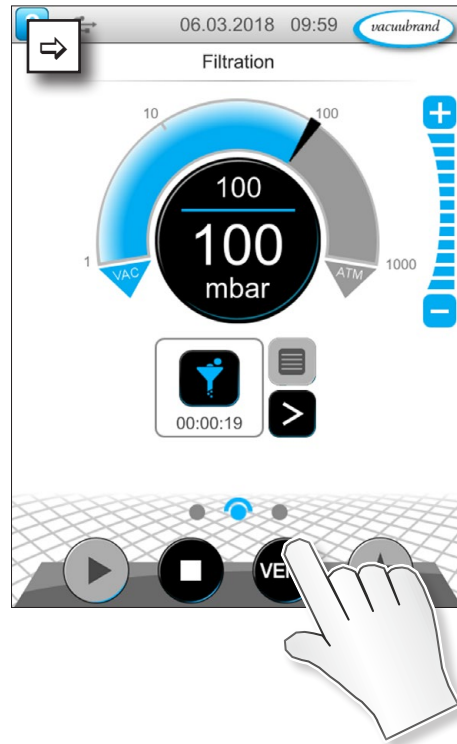

- Slight pressure increase.
- Vacuum control running.

Vent to atmospheric pressure

Continuous venting



Hold down

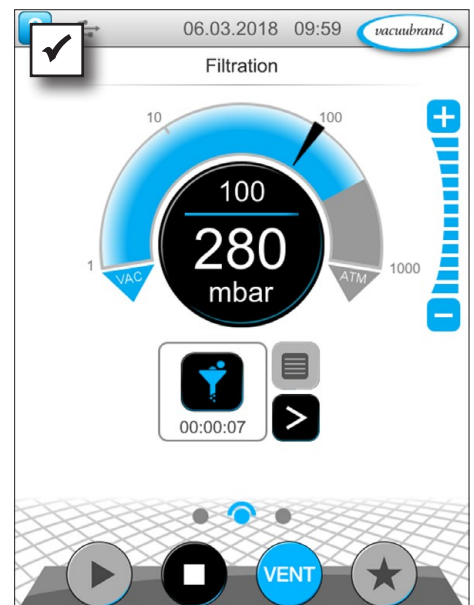
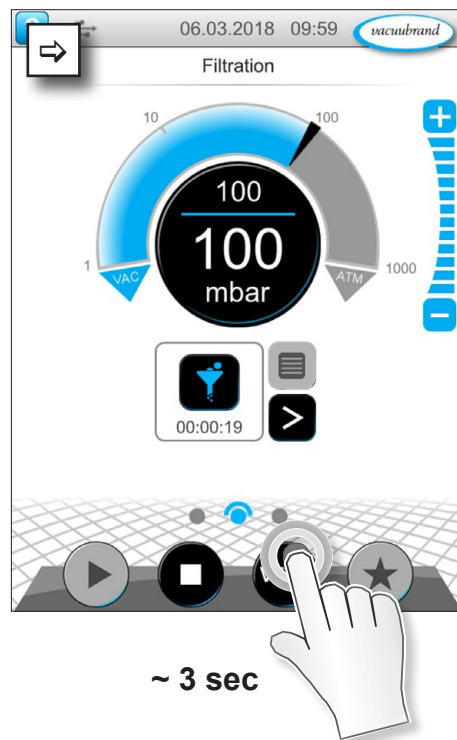

- Vacuum control stops.
- Pressure increase until atmospheric pressure is reached.

6.1.4 Stop application

Stop application



Tap/press lightly

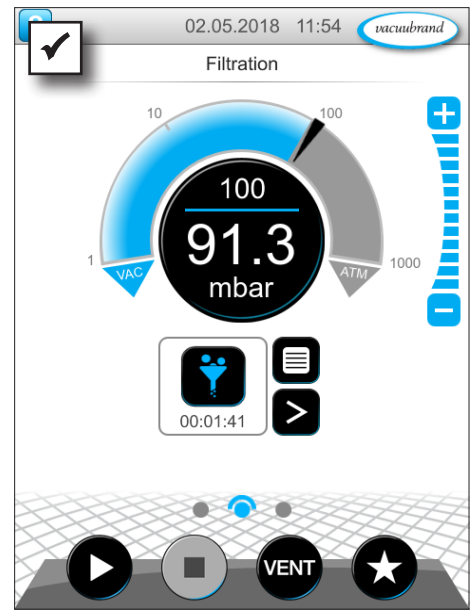
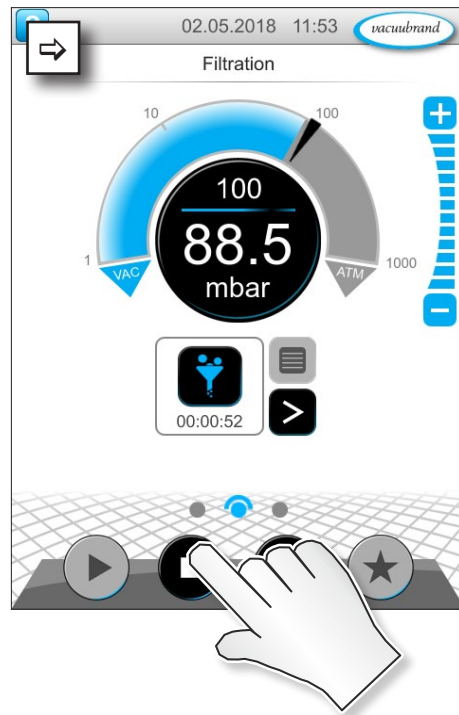

Vacuum control stops.

6.2 Application parameters (parameter list)

In the parameter list, you can individually change and adapt various process-related values before and during operation.

Adjust parameter

→ Example
Adjust motor speed

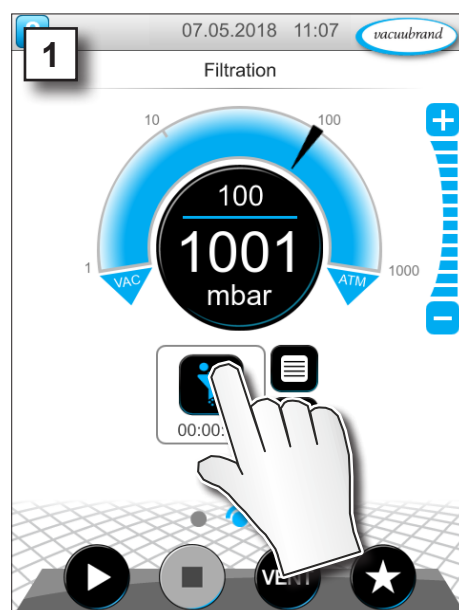

1. View parameter list.

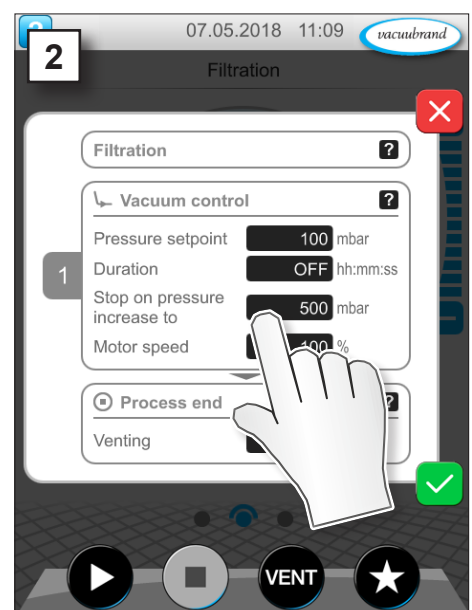

2. Tap on desired input field.

→ Example
Adjust *motor speed*
parameter

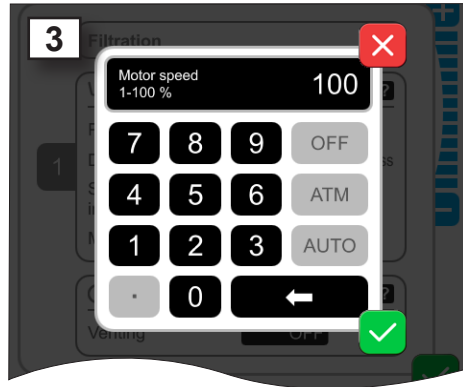

3. Enter the required motor speed in the pop-up.

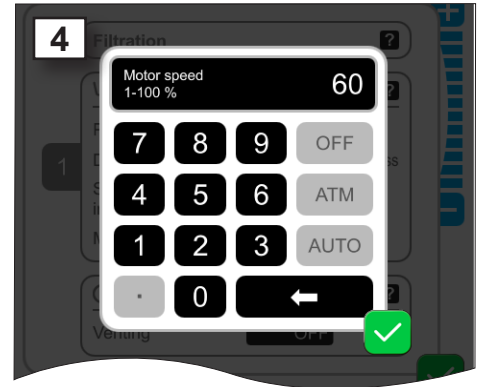

4. Confirm entry.

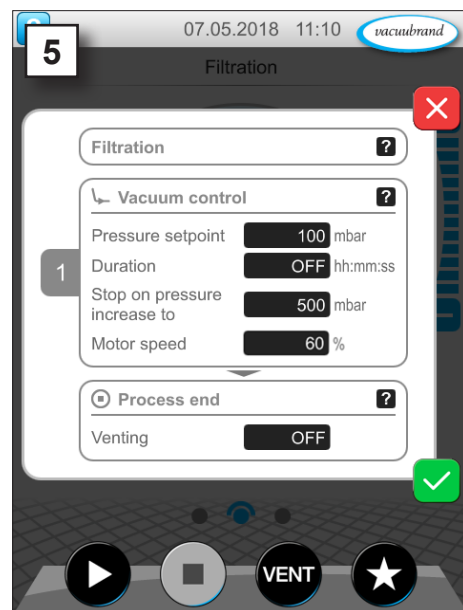
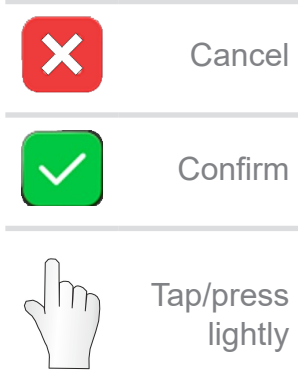

5. Confirm the change in the parameter list.

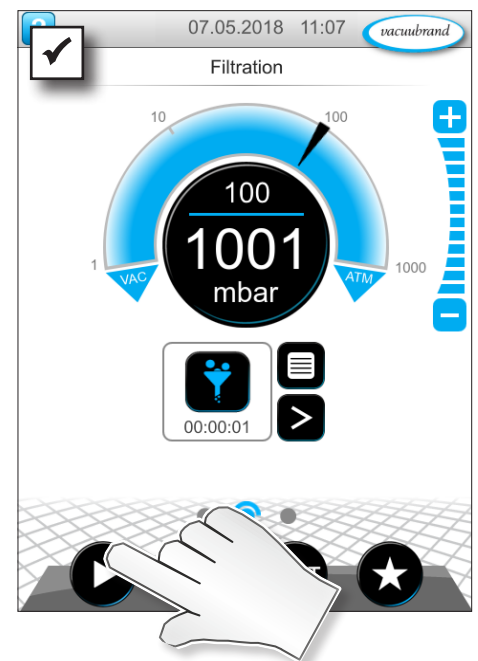

☑ Once the application starts, the motor runs at the adjusted speed.

→ Example
View of *motor speed*
parameter during
operation

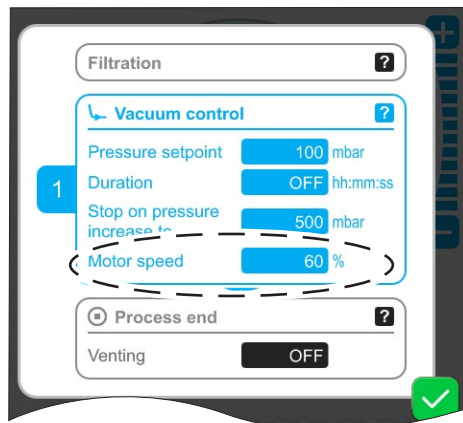

⇒ You can make individual adjustments for your process in the parameter list at any time.

6.3 Pressure graph

The *pressure graph* is on the same level as the process screen. The menu shows pressure curves of measured vacuum values. The pressure curve is shown until a new application is started, at which point it is replotted.

View Pressure graph

→ Example
View pressure graph

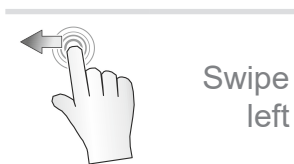

⇒ Swipe left on the display.

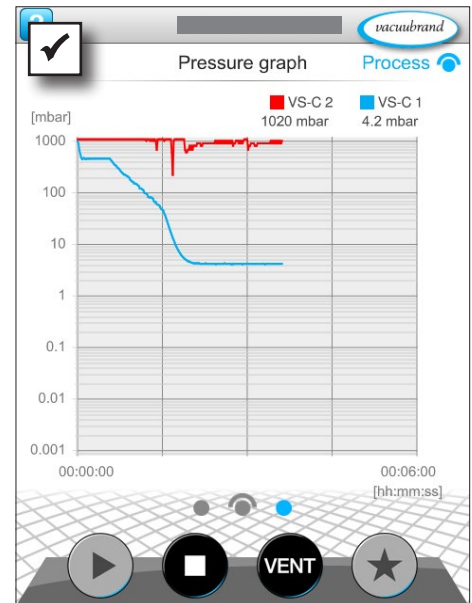

- Pressure graph display.
- Measurement curves of connected vacuum sensors.

Pressure graph display

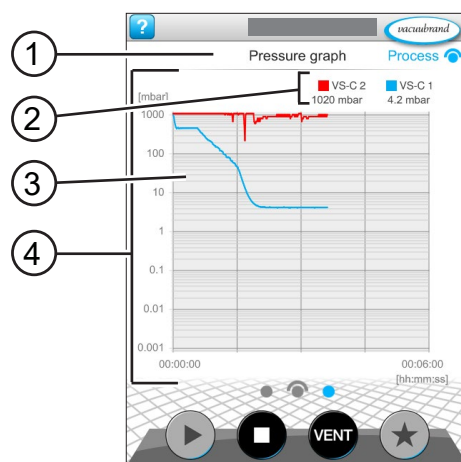

- | | |
|---|----------------------|
| 1 | Menu name |
| 2 | Key to colors |
| 3 | Measurement curve(s) |
| 4 | Pressure/time graph |

- VS-C 1 ■ VS-C 1
- VS-C 2 ■ VS-C 2

⇒ Tap on the color key of a vacuum sensor to display or hide individual measurement curves.

6.4 Main menu

The *main menu* is on the same level as the process screen. The submenus of the controller can be accessed from the main menu.

View main menu

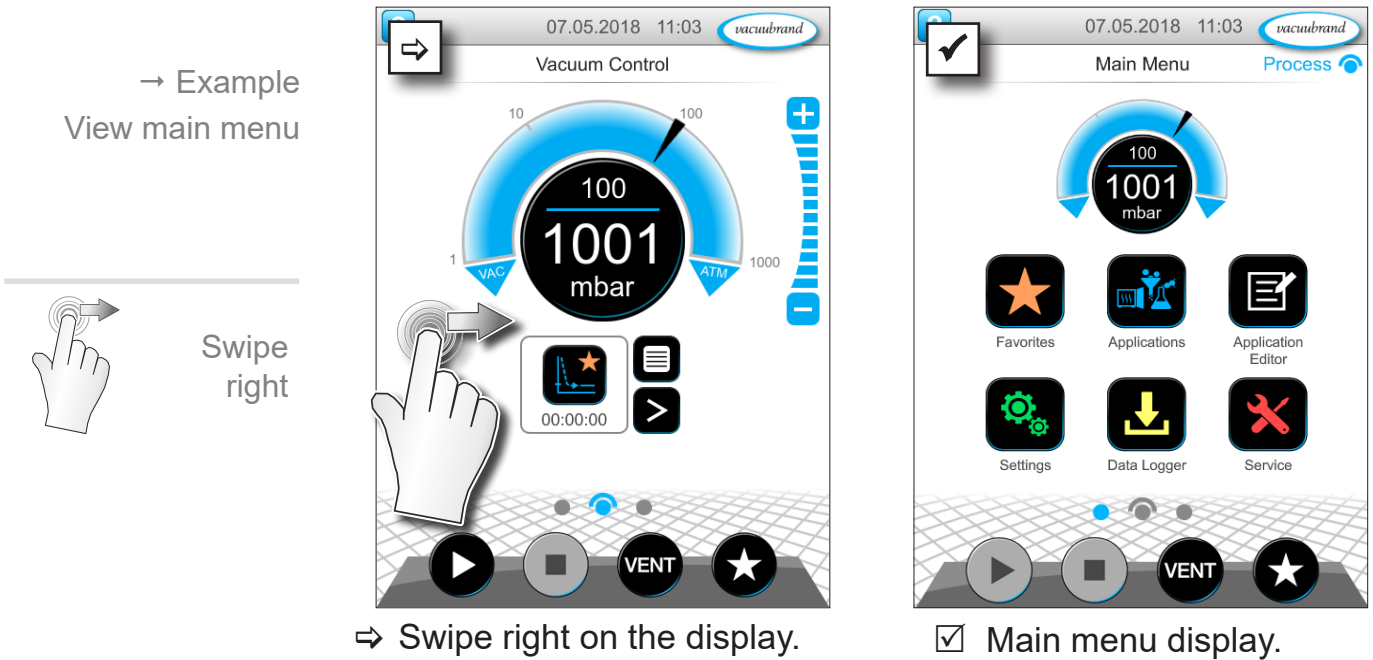

Main menu display



The function of each submenu is shown by its icon and the text below it. → See also chapter: 7.1 Advanced operation

6.4.1 Applications



This menu lists all applications: standard applications, favorites, and newly created applications.

View application menu

View applications submenu



Tap/press lightly

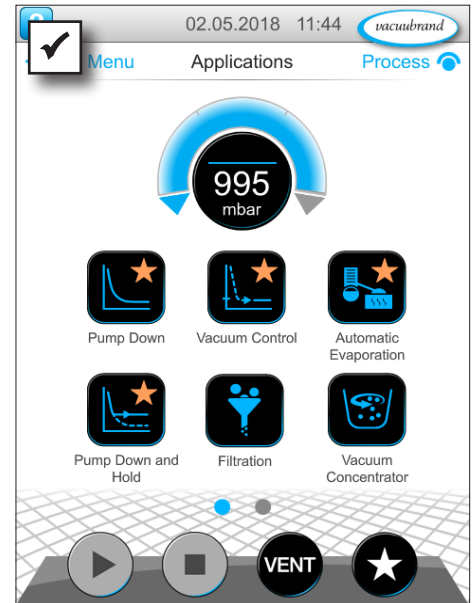
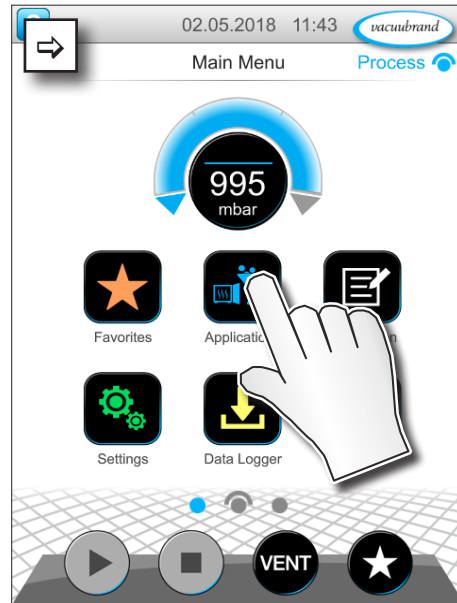

Display the applications submenu.

Show context menu

→ Example View context menu for applications



Hold down

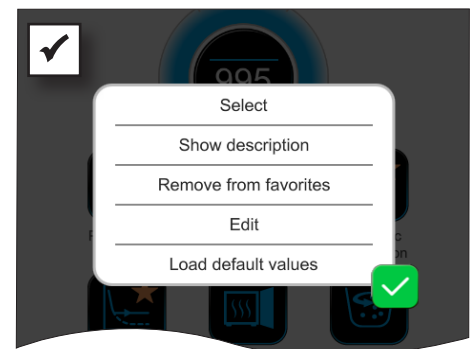
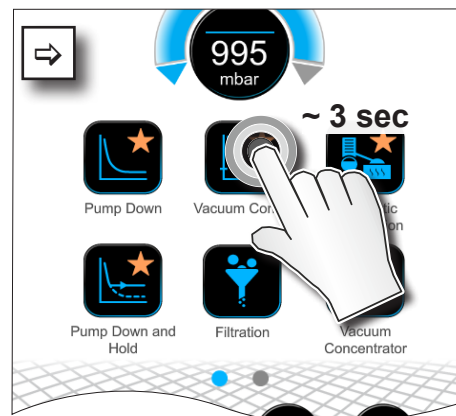

The context menu appears.

⇒ Select the required function in the context menu.



Would you like to transfer your applications to another VACUU·SELECT?

⇒ Simply use the export function as described in chapter: **7.1.9 Administration – import/export**

6.4.2 Favorites



Applications marked as favorites are identified by a star on the button.

Add favorites

→ Example
Add favorites

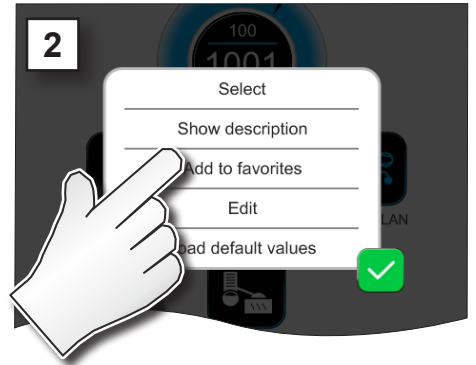
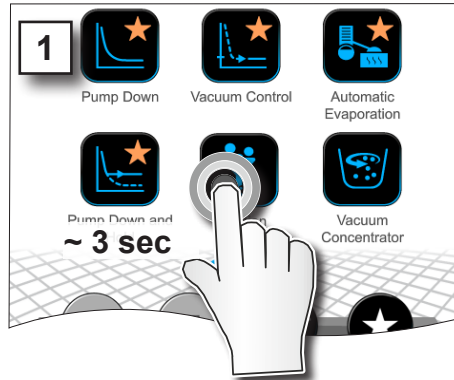

Hold down



Tap/press lightly



Confirm

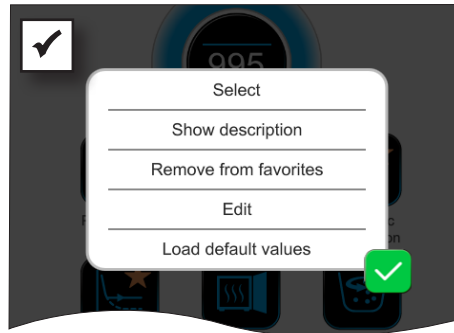

☑ Text changed in the context menu.

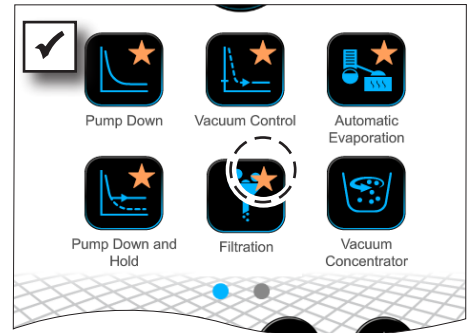

☑ Button with favorites star.
☑ Application listed in favorites menu.

Remove favorites

→ Example
Remove favorites

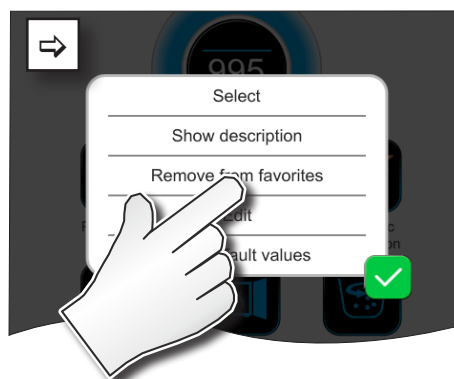

⇒ View the context menu.
⇒ Tap *Remove from favorites* and confirm.

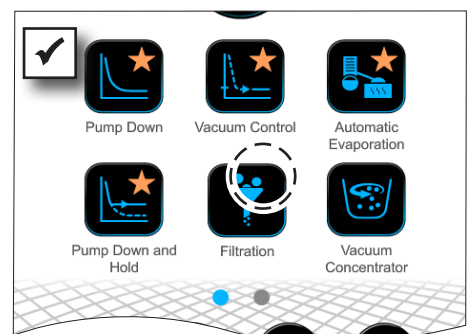

☑ Button without favorites star.
☑ Application removed from favorites menu.

7 Main menu

7.1 Advanced operation

7.1.1 Application editor



In the application editor, you can compile your own application using the building-block principle and save it with an appropriate name.

Existing applications can be used in the application editor as templates, and then saved with a new name.

In the case of lengthy applications, you can scroll through the overview of the process steps.

View application editor

→ Example
View application
editor



Tap/press
lightly

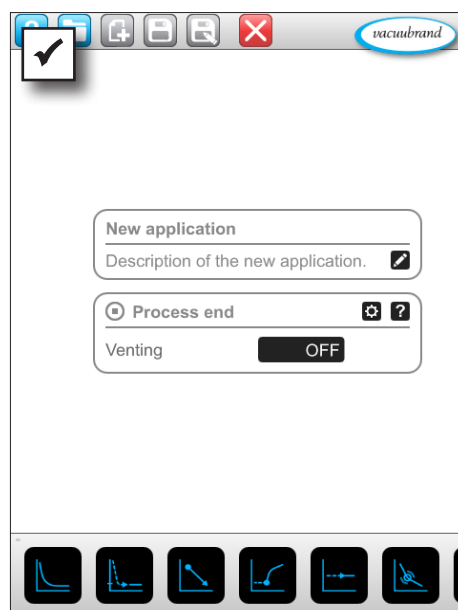
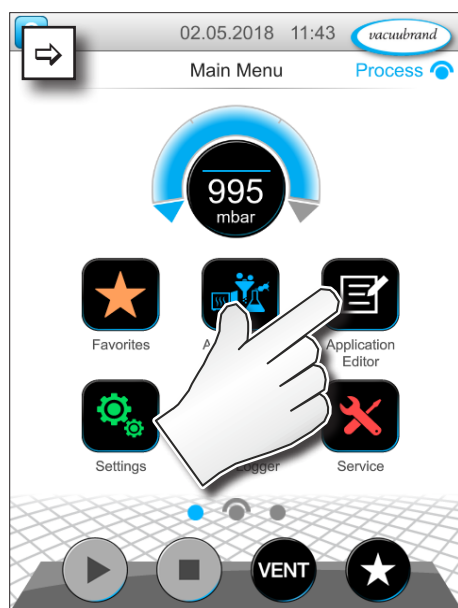

Application editor display

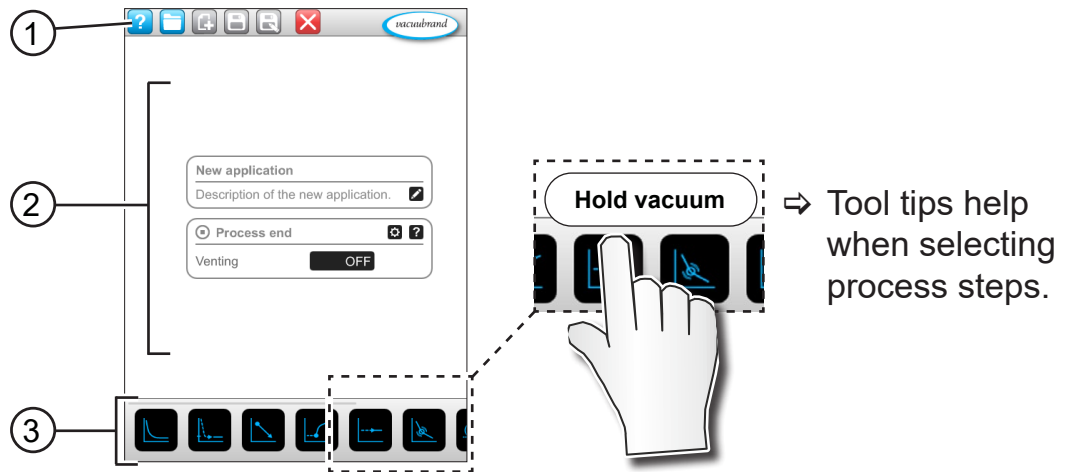

- 1 Menu bar
- 2 Overview of process steps
- 3 Building blocks with individual process steps which you can scroll through and select as required.

7.1.2 Menu bar and description

Menu bar

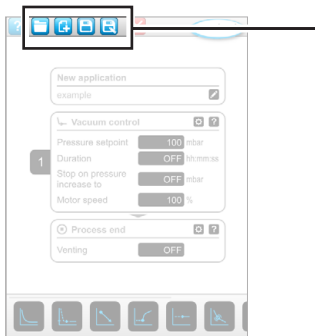

→ Example:
Application editor

Icon buttons		Meaning
Active	Locked	Application templates
	...	▶ Search for an application for editing from a series of existing applications.
		New ▶ Create a new application.
		Save ▶ Save application.
		Save as ▶ Name of the application.

Description of the application

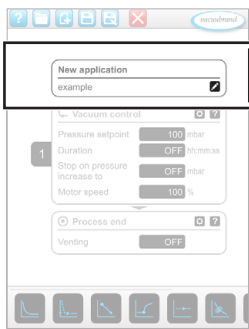

→ Example:
Application editor

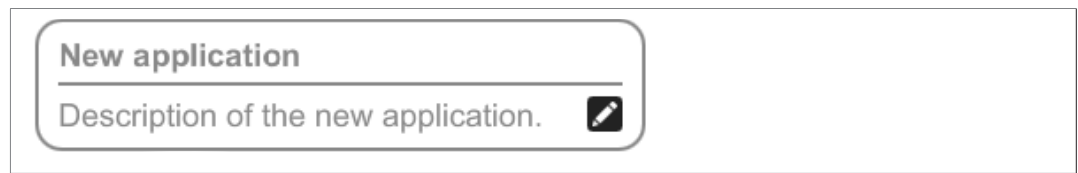

New application: this name is automatically changed as soon as you give your application an appropriate name using *Save as*.

Description of the new application: here, you can enter a brief description of your application. This description appears later in the parameter list. Custom descriptions are only shown in the creator's language.

⇒ Open the context menu to enter a description by tapping on:



7.1.3 Overview of process steps

Individual process steps can be added or removed by dragging and dropping. If a process step is dragged onto the editor screen, the image changes. The process step is shown as a numbered process step section.

Meaning of process step section(s)

→ Example
Process step
sections

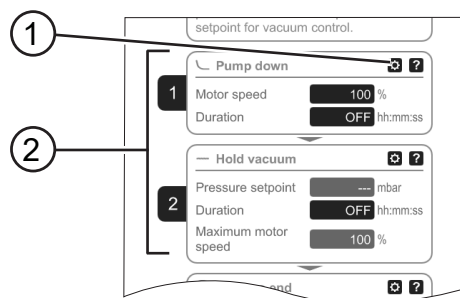

- | | |
|---|---------------------------------|
| 1 | Process step configuration |
| 2 | Process step section, numbered. |



Using the **process step configuration**, you can specify which parameters will later be displayed in the parameter list and which are available for editing.

Each **process step section** represents a process step. By holding down and moving the numbers, process step sections can be (re)arranged as desired.

As a visual aid to help you rearrange the process step sections, a **blue bar** appears at the point where they can be placed.

The process step sections are **numbered** from top to bottom, from 1 to n. If a process step section is added, shifted or removed, the numbering is adjusted automatically.

7.1.4 Process end



Process end means the defined end of an application. Process steps can only be placed in front of this.

7.1.5 Edit application

Create a new application

→ Example
Create a new application



Tap/press lightly



Hold down and drag



Release



Save as



Confirm



Exit menu

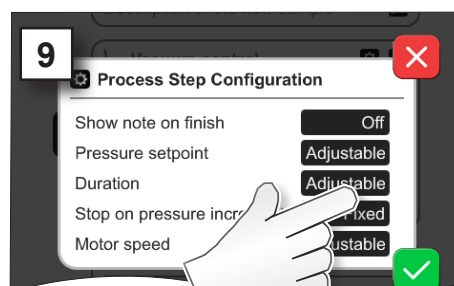
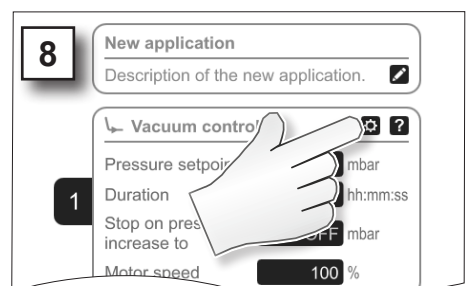
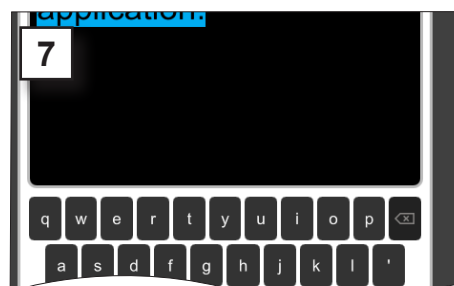
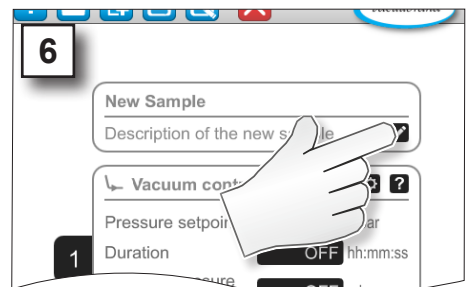
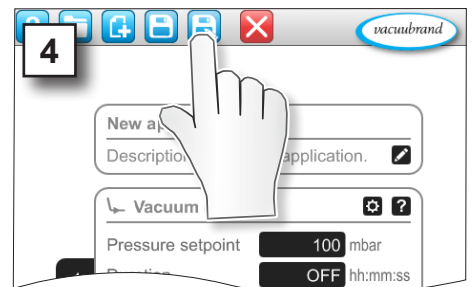
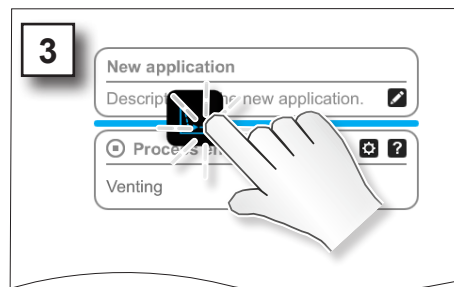
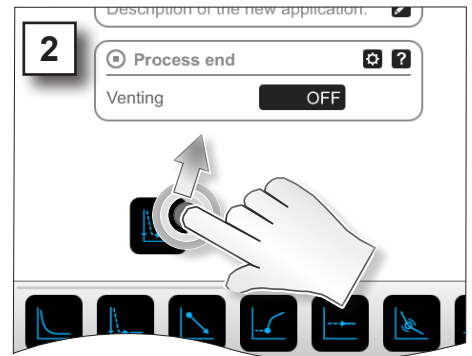

→ Example
Edit new application



Tap/press lightly



Hold down



Save



Confirm



Exit menu

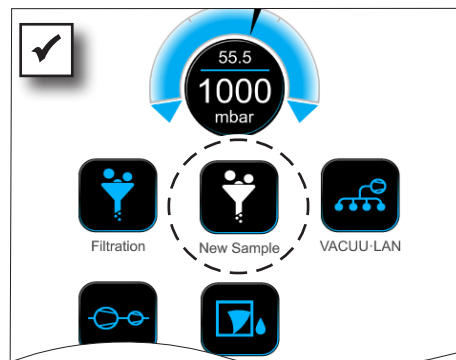
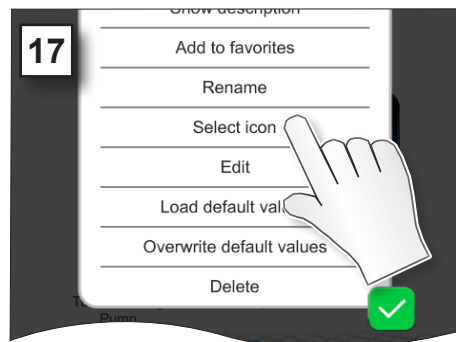
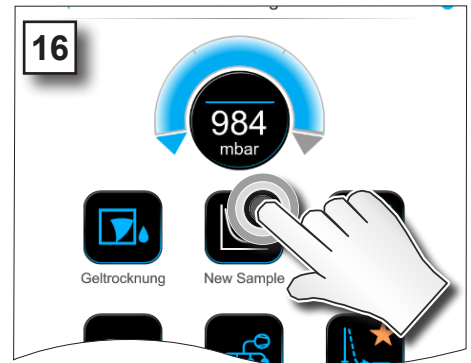
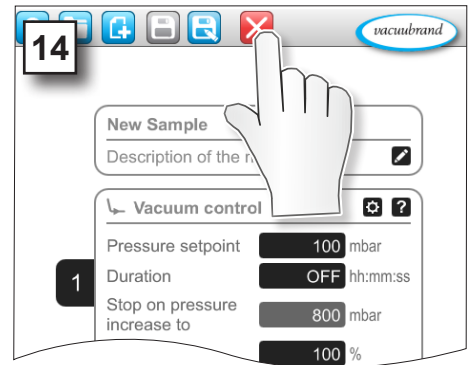
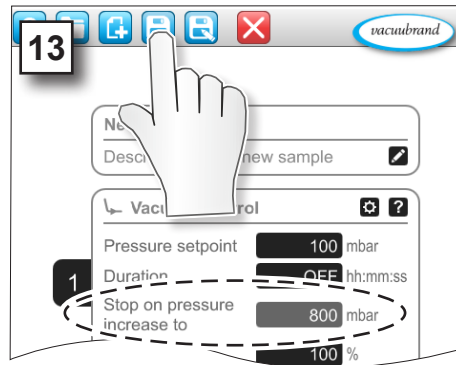
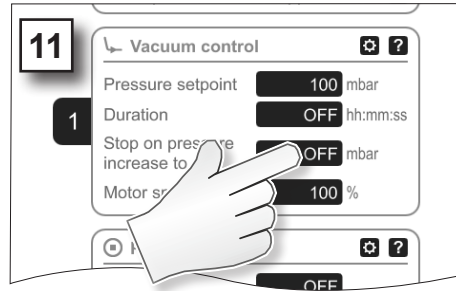

New application listed with white symbol in applications submenu.

7.1.6 Remove process step

Change application

→ Example
Edit existing
application



Hold down



Tap/press
lightly



Hold down
and drag



Release



Save



Exit menu

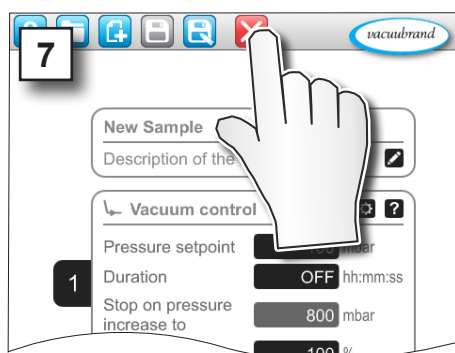
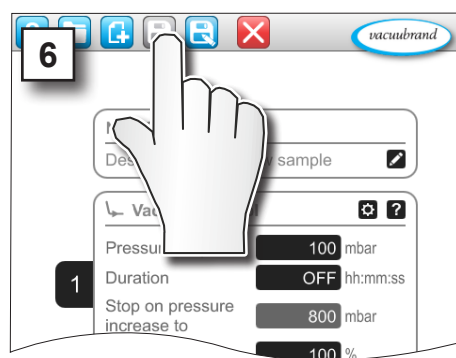
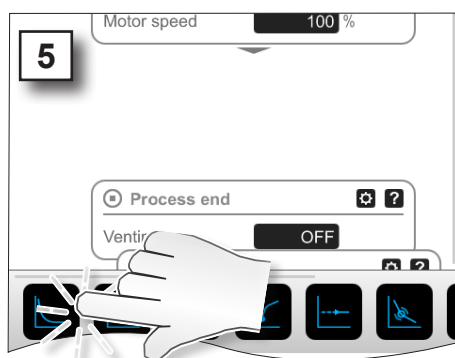
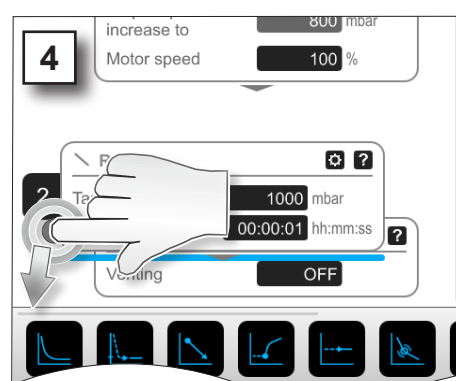
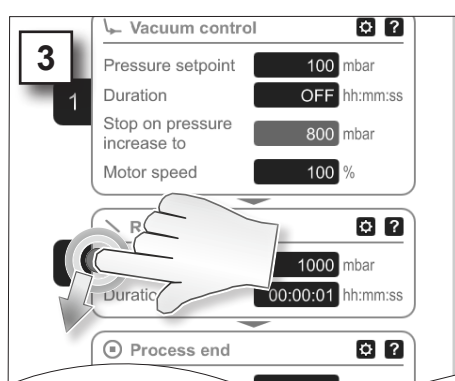
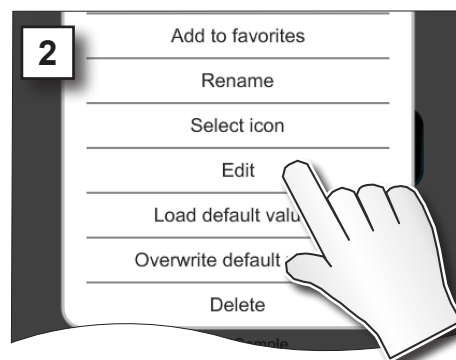
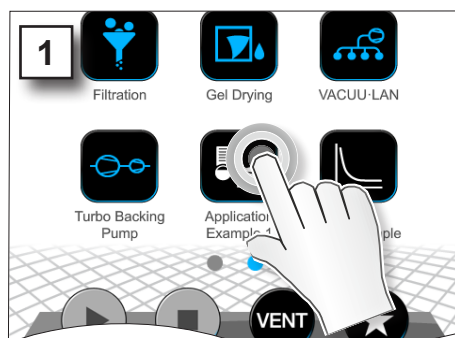

- The removed process step is no longer displayed in the parameter list of the application.

7.1.7 Settings



In this submenu you can adjust the display, switch to another language, and make presettings for connected VACUU·BUS peripheral devices.

View settings submenu

→ Example
Main menu \
Settings \ Basic
settings



Tap/press
lightly

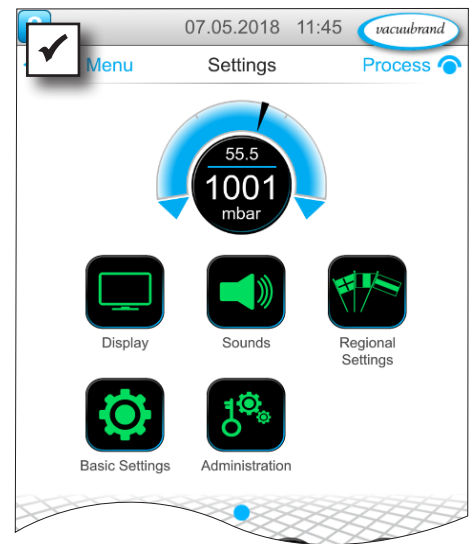

Meaning of the context menus

→ Example
Overview
Context menu
settings



Cancel



Confirm

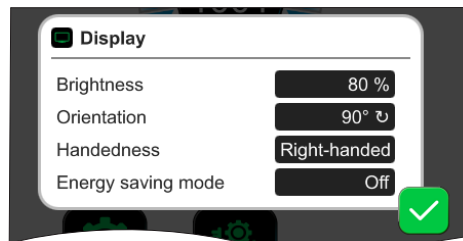

Under **Display**, you can change settings for the screen.

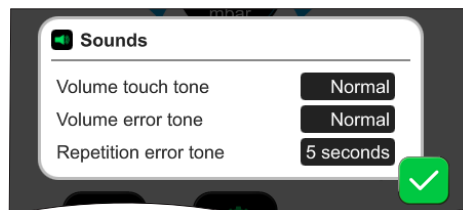

Under **Sounds**, the volume of the acoustic signals for warnings and haptics can be set or switched off.

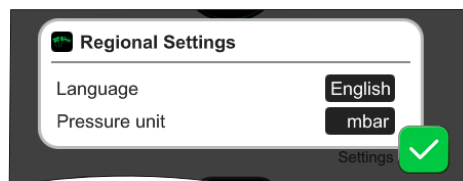

In **Regional Settings**, you can change the language and pressure unit.

→ Example
Overview
Context menu
settings

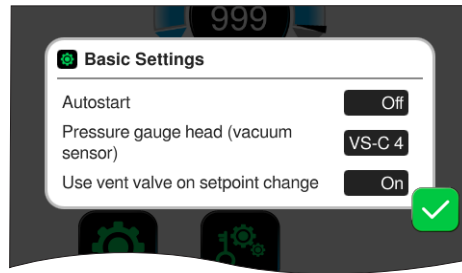

In the **Basic Settings** you can specify default settings for your process:

Overview of
possible basic
settings

Description of basic settings

Function	Setting	Description
Autostart	Off / On	Off: The controller remains on Stop when the power supply is switched on. On: A started application is continued after the power supply has dropped off (switch off or failure) and is subsequently switched on again. Recommended, for example, when an external switch in the lab furniture is to be used to start up a previously running controller.
Vacuum sensor	VS-C _ / VS-P _	Vacuum sensor selection for the controller, provided more than one is connected. VS-C _: rough vacuum; VS-P _: fine vacuum
Use venting valve when target value changes	Off / On	Off: Venting valve does not respond when target value changes. On: Venting valve responds if required for target value adjustment.
Coolant valve(s) run-on time*	Off / hh:mm:ss	Specified time for coolant run-on time.
Level sensor(s) delay time*	Off / hh:mm:ss	Delay time for switching off after full status indicator.

*Option: Shown if component is connected and recognized.

The *Basic Settings* context menu adapts to the connected **VACUU-BUS** components, e.g., a level sensor is connected and activated via *component recognition* ⇒ entry for delay time is listed in the context menu.

7.1.8 Settings/administration



Admin area of the controller – only for authorized staff.

View administration submenu

→ Example
Main menu
 \ Settings
 Administration



Tap/press
lightly

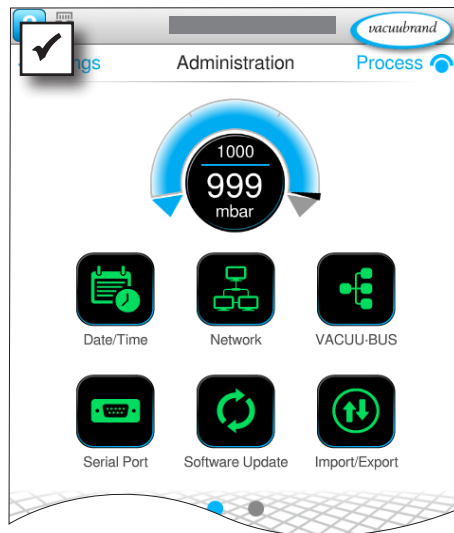

Submenu with buttons for administrative submenus.

Meaning of the context menus

→ Example
Overview
Context menus
administration

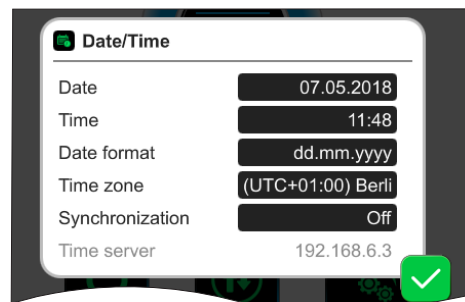

Adjustments for **date and time**.

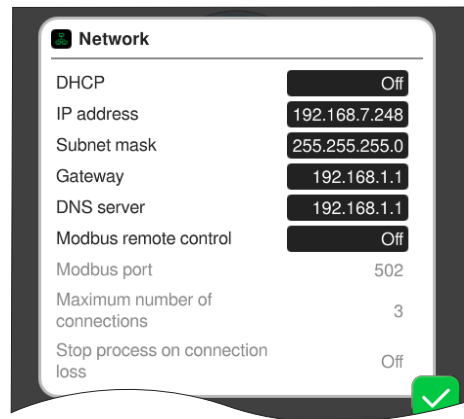

Default settings for integrating the controller into your **Network**.

Activate/deactivate remote control via Modbus.

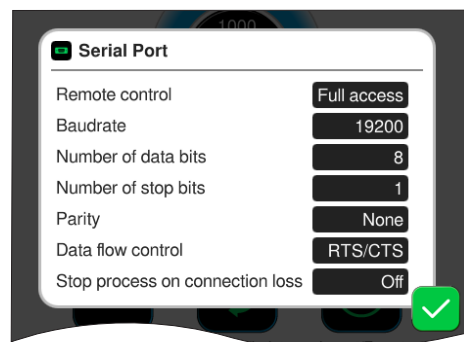

Default settings for **Serial port** and alignment of the communication settings (COM) for RS-232.

Activate/deactivate remote control via RS-232.

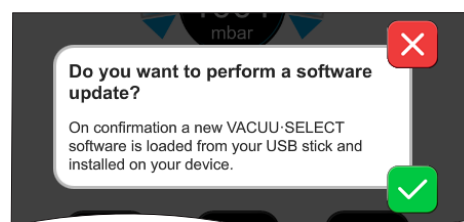

Activate command for loading **software update** from connected USB flash drive.

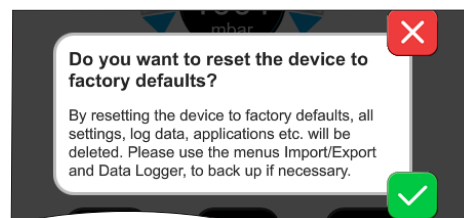

Reset the controller to the **factory settings**.

IMPORTANT!

Restoring the factory settings deletes all data, settings and applications. The data logger is switched off and recording of diagnostic data is set back to *Minimal*.

⇒ Back up your settings, applications and data beforehand; see chapters: **7.1.9 Administration – import/export** and **7.2 Data logger**

7.1.9 Administration – import/export

View import/export submenu

→ Example
Main menu
 \ Settings \
Administration \
 Import/Export



Tap/press
lightly

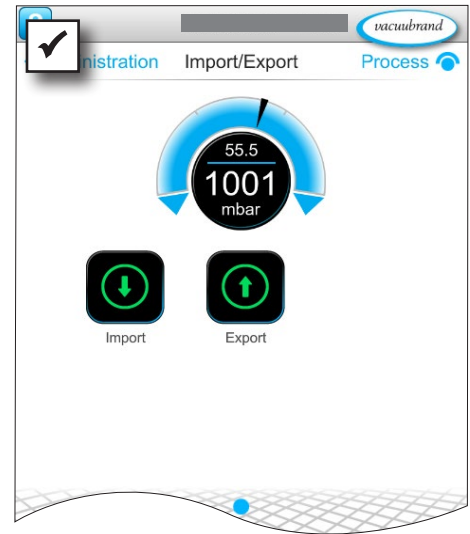
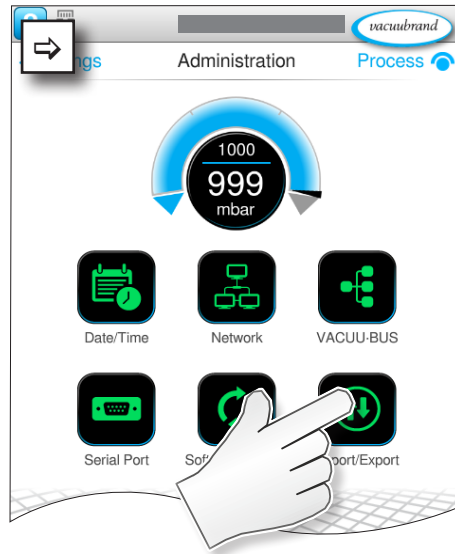

Meaning of the context menus

→ Example
Overview
Context menus
Import/Export



Cancel



Confirm

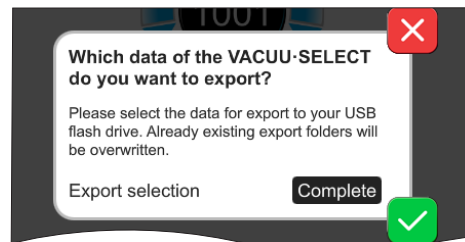

You can use the **export function** to transfer data, such as applications you have created, to other controllers via USB flash drive.

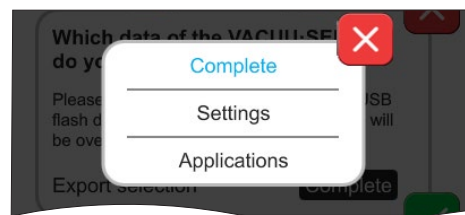

You can customize the data export by tapping **Complete**, **Settings**, or **Applications**.

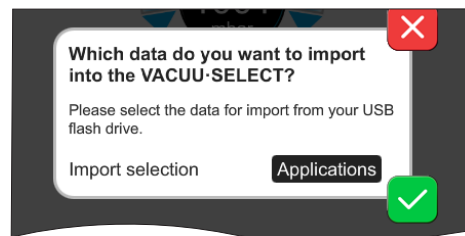

You can use the **import function** to transfer data from another external controller to this controller.

7.1.10 Administration – VACUU·BUS



The VACUU·BUS submenu simplifies the detection and management of VACUU·BUS components.

View VACUU·BUS submenu

→ Example
Main menu
 \ Settings \
Administration \
VACUU·BUS



Tap/press
lightly

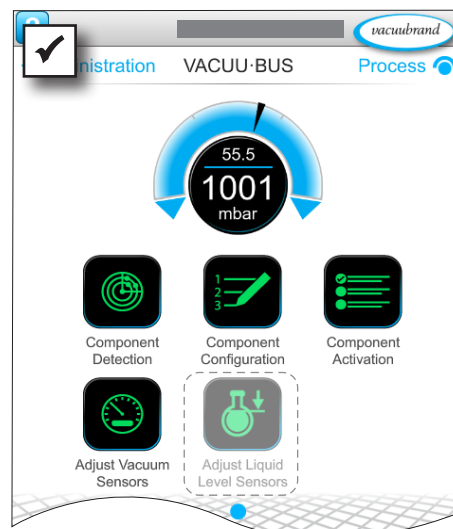
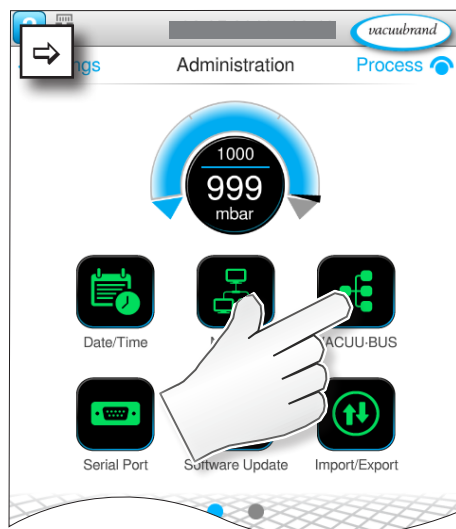

The buttons retrieve context menus. The context menus facilitate the use of presets for VACUU·BUS components, e.g., address configuration, detection of connected components. Vacuum sensors and level sensors, amongst others, can be calibrated in this submenu.

Meaning of the context menus

Overview
Context menus
VACUU·BUS



Cancel



Confirm

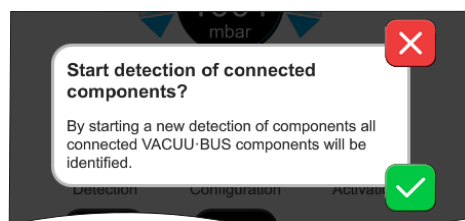

The **Component detection** function scans all connected components and updates the list of connected VACUU·BUS peripherals in the controller.

Example: If one level sensor is removed and component detection is performed, the level sensor will no longer be listed in the component configuration.

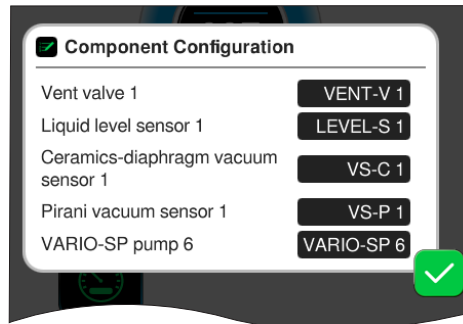

With **component configuration**, the addresses of connected components can be easily changed or reassigned.

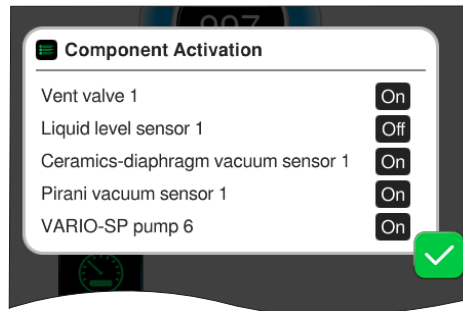

Using **component activation**, connected VACUU·BUS components can be individually activated or deactivated, i.e., the components can remain connected but are switched on or off at the controller as required for the ongoing process.

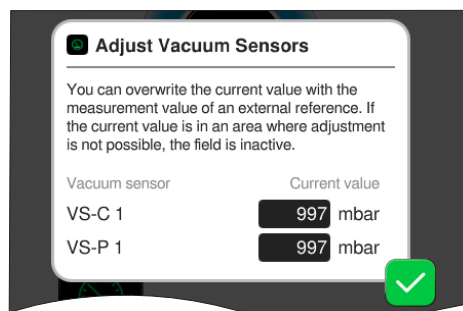

Pop-up for the **calibration** of connected **vacuum sensors** at ambient pressure and under vacuum.

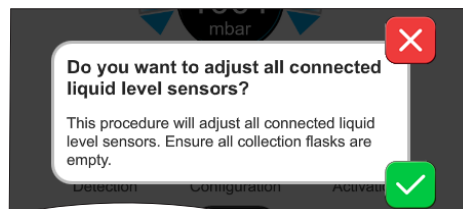

OPTION
Pop-up for the calibration of connected **level sensors**.

7.1.11 Administration/Function Enhancements



The *Function Enhancements* submenu is provided for the activation of additional functions. To activate additional functions you must have a USB stick with a valid license file or enter a license code via the on-screen keyboard.

Opening the Function Enhancements submenu

→ Example
Main Menu \
Settings \ Adminis-
tration \ Function
Enhancements



Press and
swipe
in the
direction
shown



Tap, press

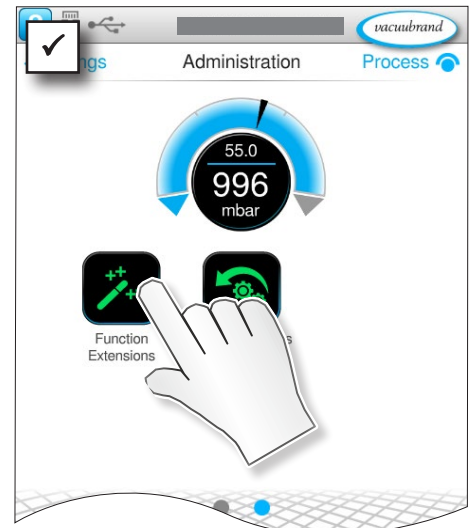
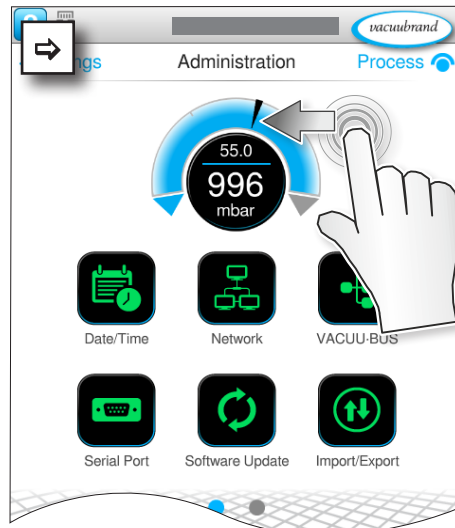

Overview
VACUU-BUS
context menu



Cancel



Confirm

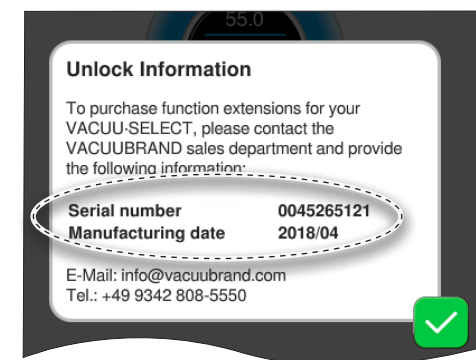

Activation Information shows you the contact details and the information that you need for your device. To order a license for activating additional functions, please always specify the serial number and manufacturing date of your device.

Function activation

If you have a valid license, please follow the user prompts that appear once you have inserted the USB stick with the license file. Alternatively, you can enter the license code using the on-screen keyboard.



<https://www.vacuubrand.com/20901537>

7.2 Data logger



If the function is switched on, the data logger records time/pressure curves and saves these at specified intervals, for a duration of up to 30 days. A separate data file is saved for each process, from start to stop.

Calling up the Data logger submenu

→ Example
Main menu \ Data logger



Tap/press lightly

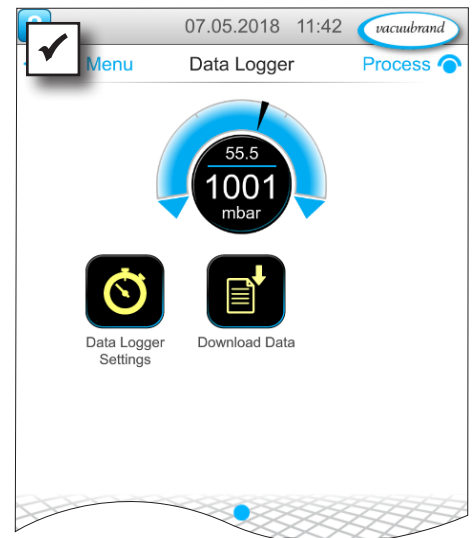

Meaning of the context menu

Overview
Context menus
Data logger



Cancel



Confirm

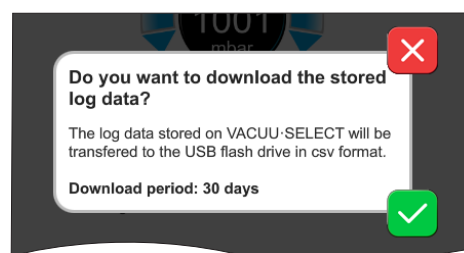
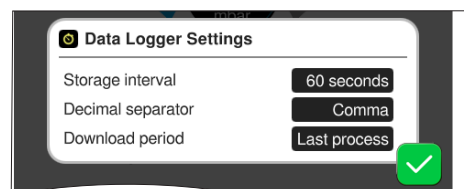

The **Data Logger Settings** enable you to select the storage interval, decimal separator and download period. Data logging can be switched off under *Storage interval*. If a USB flash drive is connected, the **log data** for the preset time period can be downloaded here.



Loading the factory settings will reset all settings of the data logger, switch logging off and delete all recorded data.

7.3 Service

In this menu, you can find or download information about the device. In the event of an error, please forward this information to our Service Department.

7.3.1 Service information

Calling up the Service submenu

→ Example
Main menu \ Service



Tap/press
lightly

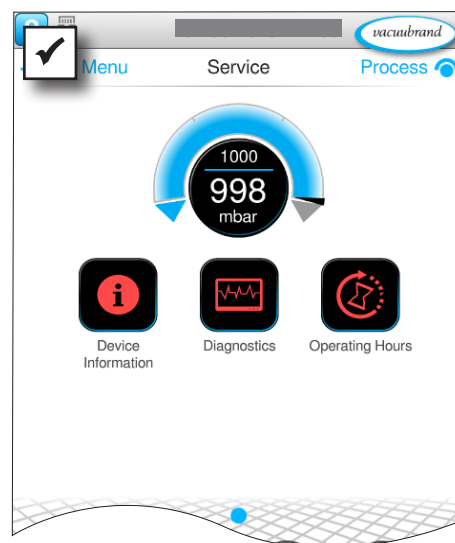

Meaning of the context menu

Overview
Context menus
Data logger



Cancel



Confirm

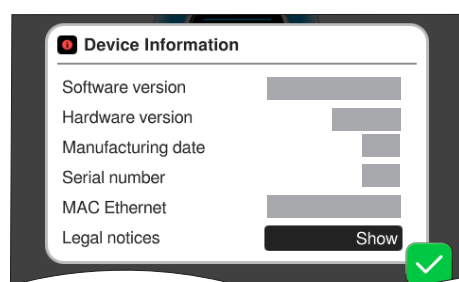

This menu displays **Device Information**.

The *Legal notices* contain licensing information.

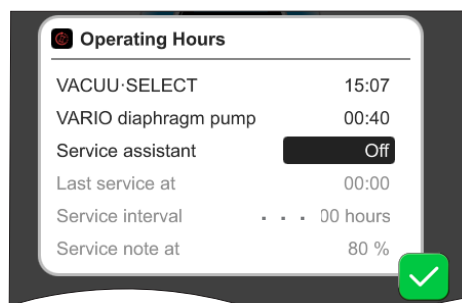

Counter for **hours of operation** with optional maintenance wizard.

Off: No reminder message.

On: Reminder message for maintenance after specified hours of operation have elapsed.

7.3.2 Diagnostic data



To improve the diagnostics of the device condition in the event of an error or service, diagnostic data is stored on the device. The data can be downloaded onto a USB flash drive via the service menu and sent to our [Customer service](#) for evaluation.

Calling up the submenu

→ Example
Main menu \
Service \
Diagnostic data



Tap/press
lightly

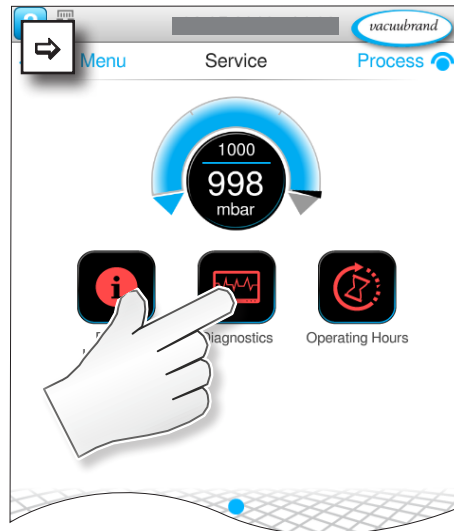

Description of context menus

Overview of
diagnostic data
context menus



Cancel



Confirm

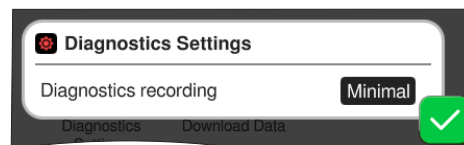

The **Diagnostic data settings** enable the extent of data recording to be adjusted.

Minimal: Recording of device data and component faults, without overpressure or full status indicator.
Complete: Same as minimal, plus parameters input by the operator and adjustment of settings.

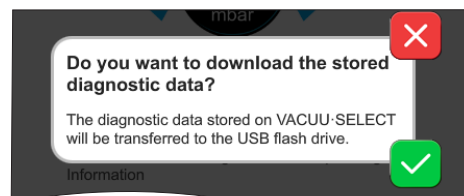

If a USB flash drive is connected, the **Diagnostic data** can be downloaded here.

8 Troubleshooting

Technical support To identify errors and potential remedies, please refer to the troubleshooting table *Error – Cause – Remedy*.

For technical assistance or errors for which you require additional support, please contact your local distributor or our [Service Department](#)¹.

8.1 Error messages

Errors are indicated immediately by the controller as plain text in a pop-up message. The status line provides a visual indication of the extent of the error. In addition, an acoustic signal is emitted while the error persists.

→ Example Error message pop-up

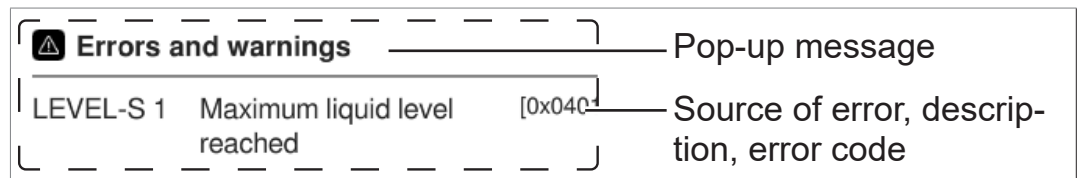

8.1.1 Error indication

Error indication

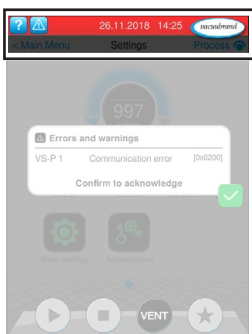

→ Example Error

Symbol	Meaning
	<p>Error indication</p> <ul style="list-style-type: none"> ▶ Indication in the case of error or warning. ▶ Tap to display text and acknowledge the error.
Color	Meaning
Yellow	<p>Warning</p> <ul style="list-style-type: none"> ▶ Indicates persisting error; process continues to run. ▶ Warnings will be reset automatically after remedy.
Red	<p>Error</p> <ul style="list-style-type: none"> ▶ Indicates persisting error; process stops. ▶ Only after fault elimination and acknowledgment of the error message the process can be restarted.
Sound	Meaning
	<p>Warning or error</p> <ul style="list-style-type: none"> ▶ Shows that an error or warning is present. ▶ Active while error status persists.

8.1.2 Acknowledge error indication

Errors must be acknowledged after the fault has been remedied.

Error information and acknowledgement

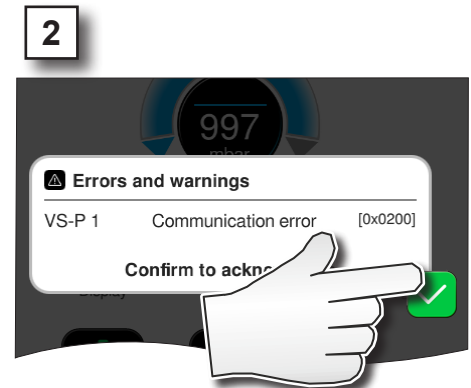
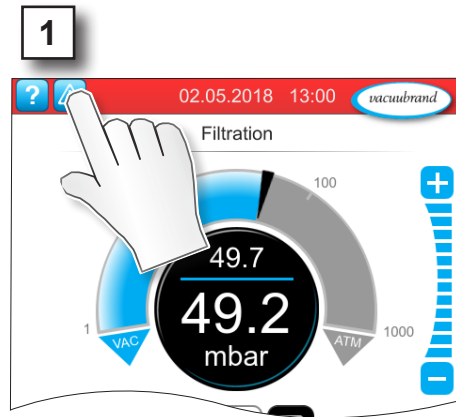
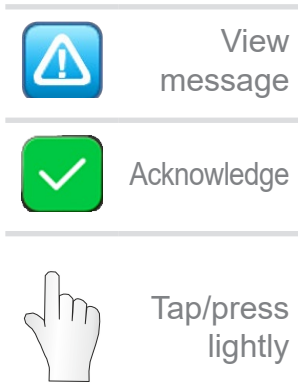

Error message reset.

8.2 Error – Cause – Remedy

8.2.1 Pop-up message

Error – Cause – Remedy

Error	Possible cause	Remedy	Personnel
Communication error	<ul style="list-style-type: none"> ▶ One or more VACUU·BUS components were removed. 	<ul style="list-style-type: none"> ✓ Deactivate relevant VACUU·BUS components. ✓ Perform component detection. 	Specialist
Error at frequency converter (FC)	<ul style="list-style-type: none"> ▶ Address incorrectly configured. ▶ Temperature too high. ▶ FC defective. 	<ul style="list-style-type: none"> ✓ Configure correct address. ✓ Replace defective component. 	Resp. specialist
Error at control system	<ul style="list-style-type: none"> ▶ Valve defective. 	<ul style="list-style-type: none"> ✓ Check address. ✓ Replace defective component. 	Specialist
Error at pump	<ul style="list-style-type: none"> ▶ Check VMS-B (switching device). 	<ul style="list-style-type: none"> ✓ Send in defective device. 	Resp. specialist
Error at digital I/O module	<ul style="list-style-type: none"> ▶ No power supply at IN of I/O module. ▶ Plug pulled out. ▶ An error occurred in the system and the I/O module relayed it to the controller. 	<ul style="list-style-type: none"> ✓ Connect power supply. ✓ Check plug-in connection. ✓ Remedy cause of external error. 	Specialist, resp. specialist

Error	▶ Possible cause	✓ Remedy	Personnel
Error at analog I/O module	▶ No power supply.	✓ Connect power supply.	Specialist
Error at Peltronic	▶ Ambient temperature too high, Peltronic overheated. ▶ Performance requirements too high. ▶ Peltronic defective.	✓ Eliminate cause of overheating of the Peltronic. ✓ Send in defective component. ✓ Replace defective component.	Specialist
Error at vacuum sensor	▶ Vacuum sensor defective.	✓ Send in defective component.	Resp. specialist
Overpressure	▶ Pressure too high. ▶ Measuring range exceeded.	✓ Acknowledge warning indication. ✓ Eliminate cause of overpressure.	Operator, specialist
Underrange	▶ Pressure below measuring range. ▶ Vacuum sensor adjustment incorrect.	✓ Calibrate vacuum sensor correctly.	Specialist
Maximum liquid level reached	▶ Full status indicator of a level sensor. ▶ Level sensor disconnected. ▶ Level sensor not adjusted correctly. ▶ Component defective.	✓ Empty the glass flask or container in question. ✓ Connect level sensor. ✓ If permanently removed, perform the VACUU · BUS component detection. ✓ Re-adjust level sensor. ✓ Exchange defective component.	Operator

8.2.2 General faults

Error	▶ Possible cause	✓ Remedy	Personnel
Display frozen	▶ Controller in undefined state. ▶ Controller has frozen.	✓ Restart the controller. Hold down ON/OFF button for more than 10 seconds until device reboots.	Operator

Error	▶ Possible cause	✓ Remedy	Personnel
No display	<ul style="list-style-type: none"> ▶ Power plug or plug-in power supply not correctly plugged in or pulled out. ▶ Pumping unit switched off. ▶ VACUU·BUS plug-in connection or cables defective or not connected. ▶ Controller switched off or defective. ▶ Device fuse tripped. 	<ul style="list-style-type: none"> ✓ Check power connection or plug-in power supply and cables. ✓ Check VACUU·BUS plug-in connection and cables to the controller. ✓ Replace defective components. 	Operator
Circuit board fuse defective	<ul style="list-style-type: none"> ▶ Short circuit on the circuit board. ▶ Defective accessory connected. ▶ Power consumption too high. 	<ul style="list-style-type: none"> ✓ Remedy cause of the short circuit and replace circuit board fuse. ✓ Send in. 	Resp. specialist
Transfer failed	<ul style="list-style-type: none"> ▶ No USB flash drive connected. ▶ Not enough storage space on the USB flash drive. 	<ul style="list-style-type: none"> ✓ Connect a USB flash drive with sufficient storage space. 	Specialist
Venting valve does not operate	<ul style="list-style-type: none"> ▶ No voltage applied. ▶ VACUU·BUS plug-in connection or cables defective or not connected. ▶ Venting valve dirty (polluted). ▶ Venting valve in sensor defective. ▶ Venting valve deactivated. 	<ul style="list-style-type: none"> ✓ Check VACUU·BUS plug-in connection and cables to the controller. ✓ Clean venting valve. ✓ If necessary, use another external venting valve. ✓ Activate venting valve in the controller. 	Specialist
No operation possible	<ul style="list-style-type: none"> ▶ Interface connected: Ethernet and/or RS-232. ▶ Operation from external terminal. 	<ul style="list-style-type: none"> ✓ Have operation enabled from external terminal. ✓ Disconnect interface connection. 	Resp. contractor
No license file found	<ul style="list-style-type: none"> ▶ No USB stick inserted. ▶ USB stick inserted without valid license. 	<ul style="list-style-type: none"> ✓ Insert a USB stick with a valid license. 	Specialist

8.3 Device fuse

There is a device fuse, type: Nano fuse 4 A/t, on the circuit board of the controller. If tripped, the fuse can be replaced under ESD conditions after the cause has been remedied.

NOTE

Damage possible if work is performed incorrectly.

- ⇒ Have maintenance work performed by a trained electrician or at least by a person with electrotechnical expertise.
- ⇒ Ensure ESD safeguards when working with the circuit board.

Change device fuse

ESD tools required: Grounding armband, flat-head screwdriver, Gr. 1, Torx screwdriver with torque of TX10, tweezers.

Change device fuse

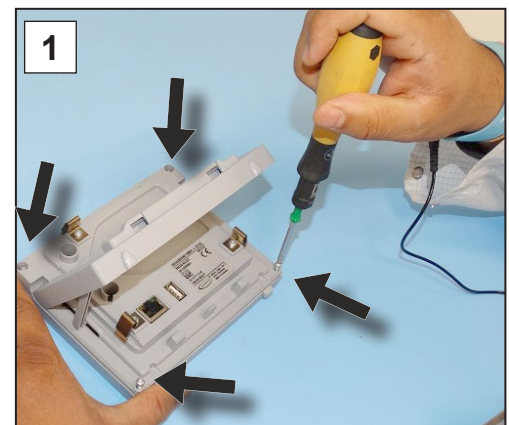

Preparation:

- ⇒ Have the tools ready (see image).
- ⇒ Disconnect the controller from the power supply.
- ⇒ Remove fitted attachments, e.g., sensor, in-line solenoid valve or benchtop housing.

1. Lay the controller carefully face down and unscrew the 4 screws in the housing.

Change device fuse

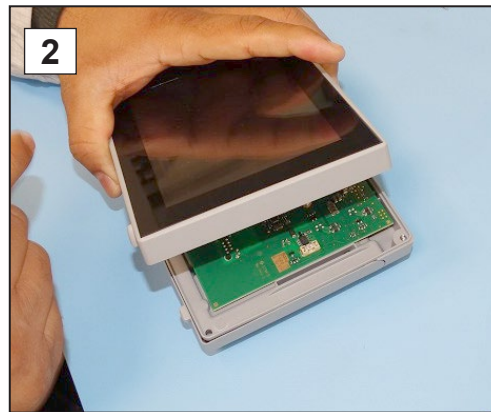

2. Carefully lift the display.

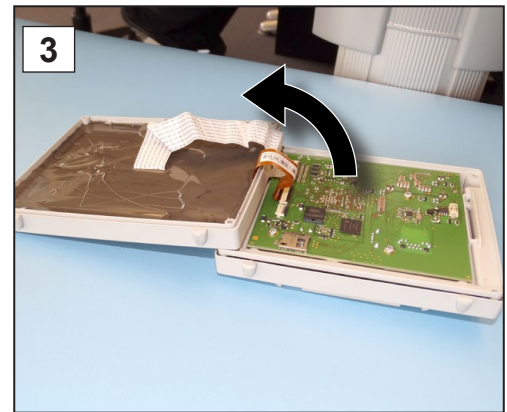

3. Carefully pivot back the display.

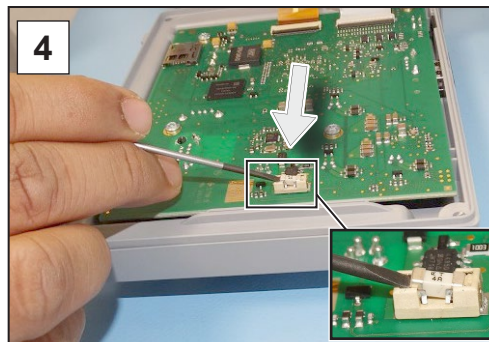

4. Lever the fuse out of the base.



5. Insert the new fuse in the base.

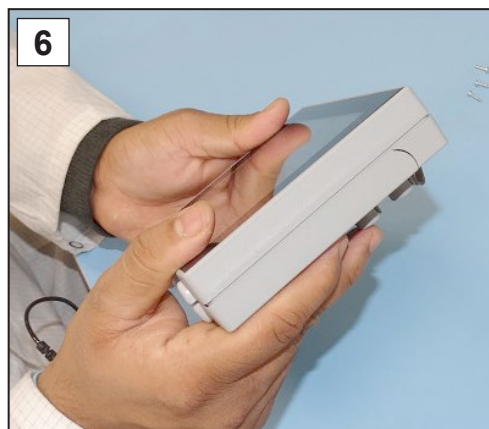

6. Close the housing tightly.

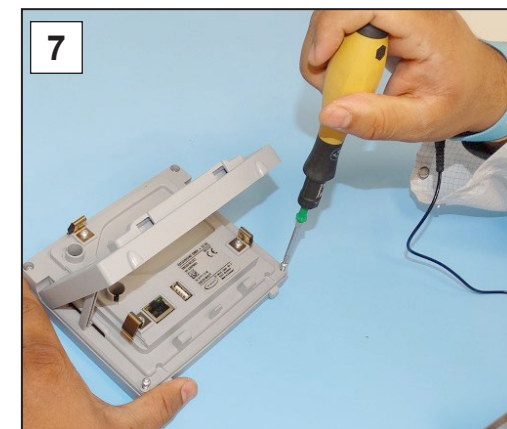

7. Tighten the housing screws using the Torx screwdriver (torque 1.1 Nm) and secure the attachments when work is complete.

Nano fuse 4 A/t

20612952

9 Appendix

9.1 Technical information

Type	
Vacuum controller	VACUU·SELECT Complete
Software version	V1.07 / V1.00

9.1.1 Technical data

Technical data

Ambient conditions		(US)
Working temperature	10-40 °C	50–104 °F
Storage/transport temperature	-10-60 °C	14-140 °F
Max. altitude	2000 m above sea level	6562 ft above sea level
Protection class (IEC 60529)	IP 40	
Protection class (IEC 60529), front	IP 41	
Protection class (UL 50E)		Type 1
Protection class (UL 50E), front		Type 2
Relative humidity	30-85 %, non-condensing	
Prevent condensation or contamination from dust or liquids		

Electrical data	
Nominal voltage	24 VDC
Controller output	1.2 W
Power supply via	VACUU·BUS
Device fuse on circuit board	Nano fuse 4 A/t

Plug-in power supply	30 W	25 W
Input voltage	90–264 VAC	100–240 VAC
Frequency	50–60 Hz	50–60 Hz
Power consumption, max.	0,8 A	0,7 A
Output current, max.	1,25 A	1,05 A
Output voltage, short circuit proof	24 VDC	24 VDC
Cable length, approx.	2 m	79 in.
Dimensions	108 mm x 58 mm x 34 mm 4.3 in. x 2.3 in. x 1.4 in.	
Weight	140–300 g	0.31–0.66 lb
Power plug	AC, replaceable: CEE/CH/UK/US/AUS/CN	

Technical data

Chemically resistant in-line solenoid valve (US)		
Power supply	24 V DC ±10 %	
Valve connector	3-pole on VACUU·BUS	
Power consumption, approx.	0.22 A	
Power	6 W	
Switching frequency/minute, max.	50	
Switching state	NO contact	NC contact
Leak rate	1*10 ⁻² mbar l/s	
Operating pressure	1.5 bar	1125 Torr

Controller interfaces	
Plug-in connector	VACUU·BUS
Ethernet (LAN)	Patch cable min. cat. 5e RJ45
USB port (1.0–2.0)	2x USB-A 2.0, max. 0.5 A per port

Controller connections	
Benchtop version, lab scaffold version	2x hose nozzles DN 6/10 mm
Built-in version	2x straight screw-in connectors DN 8/10
Venting valve, optional	Hose nozzle DN 4-5 mm

Weights (US)		
Benchtop version	745 g	1.64 lb
Lab scaffold version	590 g	1.3 lb
Built-in version		
Plug-in power supply	250 g	0.55 lb
VACUU·SELECT Sensor	145 g	0.3 lb
Chemically resistant in-line solenoid valve	210 g	0.46 lb

Dimensions

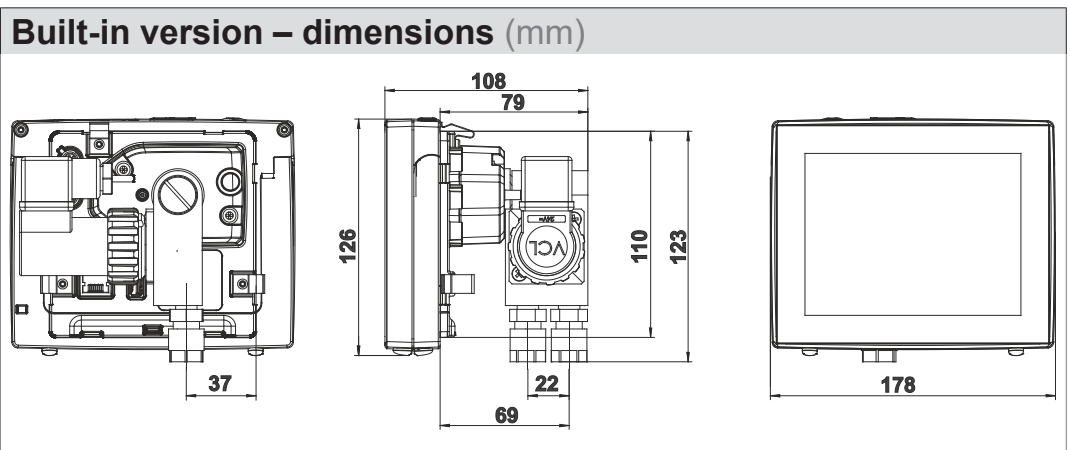
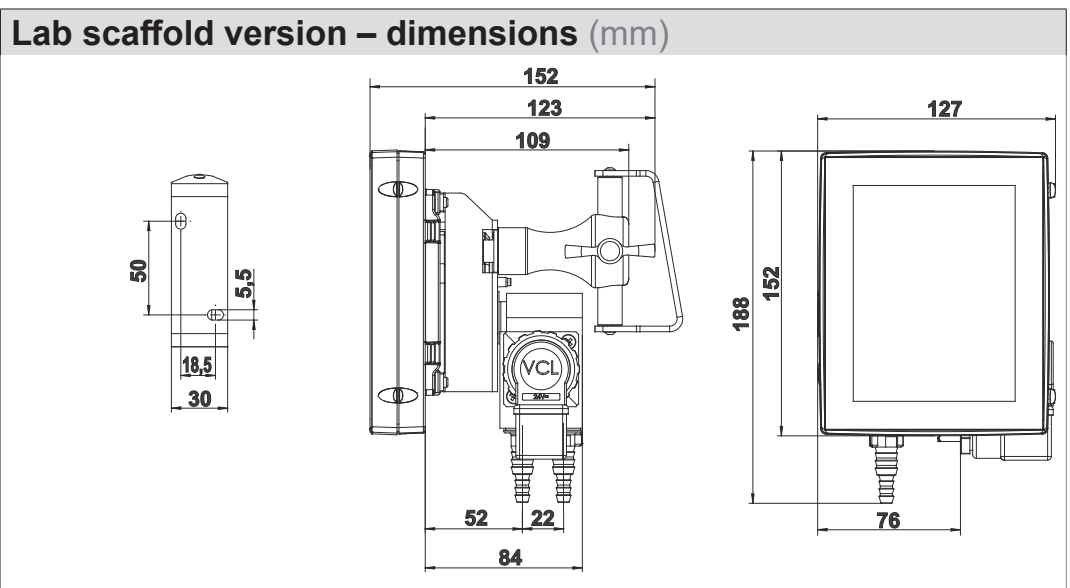
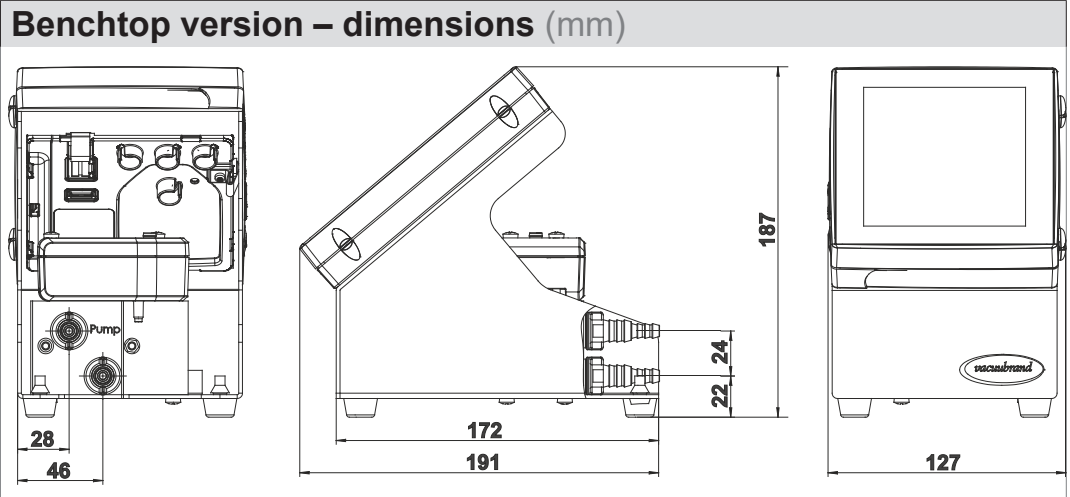

9.1.2 Rating plate



- ⇒ In the event of an error, make a note of the type and serial number on the rating plate.
- ⇒ When contacting our Service Department, please provide the type and serial number from the rating plate. This will allow us to provide you with specific support and advice for your device.

VACUU-SELECT rating plate, general

Data on rating plate

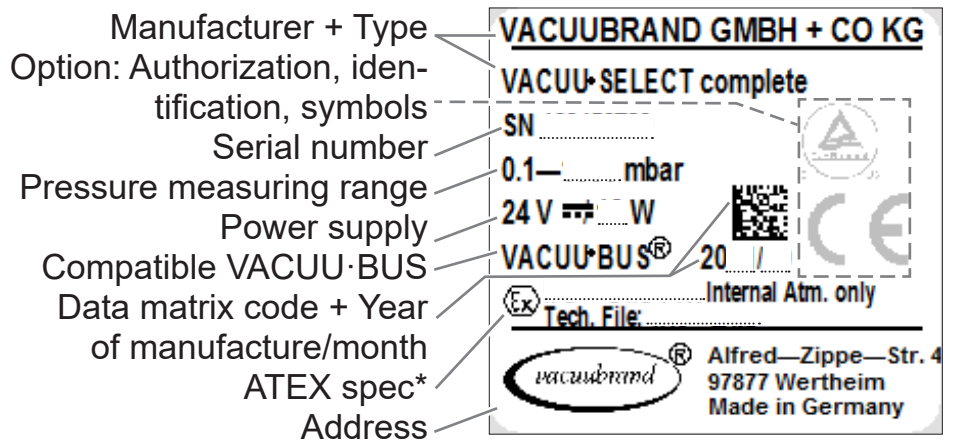

* Indicating documentation, group and category, marking G (gas), type of protection, explosion group, temperature class (see also: [Approval for ATEX equipment category](#)).

9.1.3 Wetted materials

Wetted materials

Component	Wetted materials
Sensor	Aluminum oxide ceramic, gold-coated (if applicable)
Measurement chamber	PPS
Venting valve seal	FFKM
Option: blind plugs without venting valve	Epoxy resin
Seals	Chemically resistant fluoroelastomer, PTFE
Connections to pump/application	PVDF
Valve block	PP
O-rings	FKM
Valve body	PVDF
Non-return valve	FFKM

Screw-in connector, diaphragm, sealing ring	PTFE
Hose nozzle	PP

9.1.4 Vacuum data

Vacuum data

Values	(US)	
Measuring range (abs.)	1080–0.1 mbar	810–0.1 Torr
Accuracy of measurement	±1 mbar/hPa/Torr, ±1 digit, with VACUU·SELECT vacuum controller (after adjustment, constant temperature)	
Measuring principle	Ceramic diaphragm (aluminum oxide, gold-coated), capacitive, gas type independent, absolute pressure	
Temperature coefficient	< ±0.15 mbar (hPa)/K	< ±0.11 Torr/K
Maximum admissible pressure, abs.	1.5 bar	1125 Torr
Maximum admissible media temperature (gas), non-explosive atmosphere:		
Short term (< 5 min)	80 °C	176 °F
Continuous operation	45 °C	113 °F
ATEX approval if the ATEX marking is shown on the rating plate	II 3/- G Ex h IIC T4 Gc X Internal Atm. only	
Inner part (pumped gases)	Tech.File: VAC-EX02	
Maximum admissible media temperature (gas)  atmosphere:		
Short term	40 °C	104 °F
Continuous operation	40 °C	104 °F

9.2 Ordering information

Ordering information

Vacuum controller	Order no.
VACUU·SELECT benchtop version	20700070
VACUU·SELECT lab scaffold version	20700080
VACUU·SELECT built-in version	20700060

Accessories	Order no.
Vacuum hose DN 6 mm (l = 1000 mm)	20686000
PTFE hose KF 16	20686031
Silicone rubber hose 3/6 (vent with inert gas)	20636156
VACUU·BUS wall duct	20636153
DAkKS calibration with first delivery	20900214
DAkKS recalibration	20900215
Adapter cable, USB to RS-232, 1 m	20637838
RS-232C null modem cable, 2x socket Sub-D 9-pin, 1.5 m	20637837

Overview
of possible
VACUU·BUS
components
(option)

VACUU·BUS peripheral devices		Order no.
Vacuum sensor	VACUU·SELECT Sensor	20700020
	VACUU·SELECT Sensor without venting valve	20700021
	VSK 3000	20636657
	VSP 3000	20640530
Vacuum gauge	VACUU·VIEW	20683220
	VACUU·VIEW extended	20683210
Vacuum valve (in-line solenoid valve)	VV-B 6	20674290
	VV-B 6C	20674291
	VV-B 15C, KF 16	20674210
	VV-B 15C, KF 25	20674215
Cooling water valve	VKW-B	20674220
Venting valve	VBM-B	20674217
	VACUU·SELECT Sensor	20700020
Module for switching a vacuum pump	VMS-B	20676030
...I/O module	Digital ... IN: 5-75 VDC / OUT: 60 VDC (2.5 A) IN: 5-50 VAC / OUT: 40 VAC (2.5 A)	20636228
	Analog ... IN: 0-10 V / OUT: 0-10 V	20636229
	Analog ... IN: 4-20 mA / OUT: 0-10 V	20635425
Vapor condenser	Peltronic	20699905
Level sensor	for 500 ml round bottom flask	20699908

Ordering information	Spare parts	Order no.
Spare parts	Hose nozzle DN 6/10	20636635
	Cheese head screw M6 x 10	23110179
	Non-return valve (inlet/outlet valve)	20638836
	Solenoid valve VCL-C3, 24 V DC	20636667
	Valve cable B VV, complete	20612753
	Straight screw-in connector VCL-G	20637221
	Extension cable VACUU·BUS 0.5 m	20612875
	VACUU·BUS 2 m	20612552
	VACUU·BUS 10 m	22618493
	VACUU·BUS Y adapter	20636656
	Wall power supply plug 30 W, 24 V; with adapters	20612090
	Wall power supply plug 25 W, 24 V; with adapters	20612089
	Safety information for vacuum equipment	20999254
	Instructions for use	20901170

Sources of supply

International sales offices and distribution

Purchase original accessories and original spare parts from a subsidiary of **VACUUBRAND GMBH + CO KG** or your local distributor.



- ⇒ Information about our complete product range is available in the current [product catalog](#).
- ⇒ Your local distributor or **VACUUBRAND GMBH + CO KG** [sales office](#) is available to assist you with orders, questions on vacuum control and optimal accessories.

9.3 Licensing information and data protection

- ⇒ This product contains open source software. The associated licensing information can be found in the VACUU·SELECT, in the service menu
 - *Device Information* under the heading *Legal notices*
- ⇒ The controller records data for diagnostic purposes. The recording of *Diagnostic data* can be minimized. Restoring the factory settings will cause this data to be deleted.

To display Legal notices or adjust Diagnostic data

→ See chapter: **7.3 Service on page 78**

9.4 Service

Service offer and service range

Take advantage of the comprehensive range of services available from **VACUUBRAND GMBH + CO KG**.



Services in detail

- Product consultation and practical solutions
- Fast delivery of spare parts and accessories
- Professional maintenance
- Immediate repairs processing
- On-site service (on request)
- [Calibration](#) (DAkkS-accredited)
- With Health and Safety Clearance form: return, disposal.

⇒ Visit our website for further information: www.vacuubrand.com.

Service handling

Follow the terms of service

1. Contact your local distributor or our Service Department.
2. Request an RMA no. for your order.
3. Clean the product thoroughly or if necessary, decontaminate it professionally.
4. Download the [Health and Safety Clearance](#) form.
5. Fill out the Health and Safety Clearance form in full.

Return (reshipment)

6. Return your product, including:
 - RMA no. and description of the error
 - Repair or service order
 - Health and Safety Clearance form
 - Attach everything to the outside of the package



⇒ Reduce downtime, speed up processing. Please have the required data and documents at hand when contacting our Service Department.

- ▶ Your order can be quickly and easily processed.
- ▶ Hazards can be prevented.
- ▶ A brief description and/or photos will help locate the source of the error.

9.5 Index

A		Explanation of safety symbols	10
Abbreviations.....	12	Explanation of usage conditions X ...	20
Action steps.....	11	F	
Add favorites.....	61	Foreseeable misuse	15
Additional symbols.....	10	Front view	23
Adjust motor speed.....	56, 57	Function enhancements	76
Adjust parameter	57	G	
Adjust pressure setpoint.....	49	Gestures	43
Administration.....	71	Goods receipt	31
Anschluss Ethernet.....	30	H	
Anschluss RS-232.....	30	Handling instructions	11
ATEX equipment category.....	19	Health and Safety Clearance form ...	93
ATEX equipment labeling	19	I	
B		Icons	10
Basic settings	69, 70	Import/export	73
Benchtop device.....	32	Improper use	15
Benchtop version.....	21, 32	Instruction modules	8
Built-in device	35	Interfaces, lab scaffold version	24
Built-in version	21, 35	K	
C		Kontextmenüs VACUU·BUS.....	79
Change device fuse.....	84, 85	L	
Change language	69	Lab scaffold device.....	32
Color coding of status bar.....	46	Lab scaffold version.....	21, 32
Connection options.....	39	Landscape	44
Connect venting valve	41	Landscape view.....	44
Context menu for applications	60	Limitation of use	31
Context menus VACUU·BUS	74	Lizenzinformationen	78, 92
Continuous venting.....	55	Lizenzinformationen aufrufen	92
Controller versions.....	21	Logging ausschalten.....	77
Copyright ©	7	M	
Country-specific Interchangeable plug.....	37	Main screen.....	45
Create application.....	66	Mandatory sign.....	10
CU Certificate	98	Manual structure.....	8
Cut-out dimensions.....	35	Measurement chamber.....	89
D		Modbus aktivieren/deaktivieren.....	72
Data logger	77	Mount the wall bracket.....	33
Datenspeicherung	43	O	
Description of vacuum controller	21	ON/OFF button	42
Description of VACUU·SELECT® Sen- sor.....	26	Operating elements and symbols	48
Diagnosedaten	79	Operating elements for control	51
Diagnosedaten abschalten (Daten- schutz).....	92	Operating elements – process steps	50
Diagnosedaten löschen	92	Operating panel	13
Display and operating elements	45	Operating steps	11
Display conventions.....	9	Operating steps as graphics.....	11
Display elements	46	Ordering information.....	91
Display of operating steps	11	P	
Disposal.....	20	Parameter list	56
Distributors	92	Pivot stand holder 90°	34
E		Pivot valve block 90°	36
EC Declaration of conformity.....	96	Plug-in power supply	37
Edit application	67	Pop-up window	47
Electrical connection.....	37	Portrait	44
Error – Cause – Remedy.....	81	Portrait view.....	44
Error message pop-up.....	80	Power supply	38

Power supply to controller	38	Vacuum connection	39
Power supply via plug-in		Vacuum connection, hose nozzle	40
power supply	37	Vacuum connection PTFE	40
Pressure display PC 520, PC 620	46	Vacuum data.....	90
Prevent explosive mixtures.....	19	VACUU·SELECT® Sensor.....	26
Process screen.....	45	VACUU·VIEW.....	91
Process step.....	64	VACUU·VIEW extended	91
Process step configuration	64	Vent briefly.....	55
Process step section	64	Venting connection (option).....	41
Product description.....	21	Vent with ambient air	41
Product-specific terms	13	Vent with inert gas	41
Prohibition sign.....	10	View application editor.....	62
Protective clothing	17	View applications submenu	60
Q		View main menu	59
Quality standard	17	View pressure graph.....	58
R		W	
Rating plate	26, 89	Warning symbol	10
Remove favorites.....	61	Wetted materials.....	89
Responsibility matrix.....	16		
Return (reshipment).....	93		
RS-232 aktivieren/deaktivieren.....	72		
S			
Safety	7		
Safety information.....	14		
Safety information for vacuum equip- ment.....	14		
Screen orientations.....	44		
Select application	52		
Service.....	78		
Service handling	93		
Service range	93		
Side view	23		
Sounds	46		
Sources of supply.....	92		
Spare parts	92		
Standard pressure display.....	46		
Start application.....	52		
Status bar	48		
Stop application	56		
Switch on device.....	42		
Symbols.....	10		
Symbols with operating function.....	49		
T			
Technical data.....	86, 87		
Technical support.....	80		
Term definitions	13		
Tool tips	63		
Top view.....	25		
Touchscreen operation	43		
U			
UKCA Declaration of Conformity	97		
User information	7		
V			
VACUU·BUS®.....	13		
VACUU·BUS accessories.....	91		
VACUU·BUS® connector	13		
VACUU BUS context menu	76		
VACUU·BUS simplified.....	74		

9.6 EC Declaration of conformity

EC Declaration of
conformity

EG-Konformitätserklärung
EC Declaration of Conformity
Déclaration CE de conformité



Hersteller / Manufacturer / Fabricant:

VACUUBRAND GMBH + CO KG · Alfred-Zippe-Str. 4 · 97877 Wertheim · Germany

Hiermit erklärt der Hersteller, dass das Gerät konform ist mit den Bestimmungen der Richtlinien:

Hereby the manufacturer declares that the device is in conformity with the directives:

Par la présente, le fabricant déclare, que le dispositif est conforme aux directives:

- 2014/30/EU
- 2014/35/EU
- 2014/34/EU
- 2011/65/EU, 2015/863
- 2009/125/EG, (EU) 2019/2021

Vakuum- Controller/ Vacuum controller / Regulateur de vide:

Typ / Type / Type: **VACUU-SELECT complete**

Artikelnummer / Order number / Numéro d'article: 20700060, 20700070, 20700080, 22615724

Seriennummer / Serial number / Numéro de série: Siehe Typenschild / See rating plate / Voir plaque signalétique

Angewandte harmonisierte Normen / Harmonized standards applied / Normes harmonisées utilisées:

DIN EN 61326 -1 :2013

DIN EN 61010-1:2020, IEC 61010-1:2010 + COR:2011 + A1:2016, modifiziert / modified / modifié + A1:2016/
COR1:2019

DIN EN 1127-1:2019, DIN EN ISO 80079-36:2016

DIN EN IEC 63000:2019

Bevollmächtigter für die Zusammenstellung der technischen Unterlagen / Person authorised to compile the
technical file / Personne autorisée à constituer le dossier technique:

Dr. Constantin Schöler · VACUUBRAND GMBH + CO KG · Germany

Ort, Datum / place, date / lieu, date: Wertheim, 09.01.2023

(Dr. Constantin Schöler)

Geschäftsführer / Managing Director / Gérant

ppa.

(Jens Kaibel)

*Technischer Leiter / Technical Director /
Directeur technique*

VACUUBRAND GMBH + CO KG

Alfred-Zippe-Str. 4
97877 Wertheim

Tel.: +49 9342 808-0

Fax: +49 9342 808-5555

E-Mail: info@vacuubrand.com

Web: www.vacuubrand.com

VACUUBRAND®

9.7 UKCA Declaration of Conformity

UKCA Declaration of
Conformity

Declaration of Conformity



Manufacturer:

VACUUBRAND GMBH + CO KG · Alfred-Zippe-Str. 4 · 97877 Wertheim · Germany

Hereby the manufacturer declares that the device is in conformity with the directives:

- Electromagnetic Compatibility Regulations 2016 (S.I. 2016 No. 1091, as amended by S.I. 2019 No. 696)
- Electrical Equipment (Safety) Regulations 2016 (S.I. 2016 No. 1101, as amended by S.I. 2019 No. 696)
- The Equipment and Protective Systems Intended for Use in Potentially Explosive Atmospheres Regulations 2016 (S.I. 2016 No. 1107, as amended by S.I. 2019 No. 696)
- The Restriction of the Use of Certain Hazardous Substances in Electrical and Electronic Equipment Regulations 2012 (S.I. 2012 No. 3032)
- The Ecodesign for Energy-Related Products and Energy Information Regulations 2021 (S.I. 2021 No. 745)

Vacuum controller:

Type: **VACUU-SELECT complete**

Order number: 20700060, 20700070, 20700080, 22615724

Serial number: See rating plate

Designated standards applied:

EN 61326 -1:2013

EN 61010-1:2010+A1:2019, EN 61010-1:2010/A1:2019/AC:2019-04

EN 1127-1:2019, EN ISO 80079-36:2016

EN IEC 63000:2018

Person authorised to compile the technical file:

Dr. Constantin Schöler · VACUUBRAND GMBH + CO KG · Germany

Place, date: Wertheim, 09.01.2023

(Dr. Constantin Schöler)

Managing Director

ppa.

(Jens Kaibel)

Technical Director

VACUUBRAND GMBH + CO KG

Alfred-Zippe-Str. 4
97877 Wertheim

Tel.: +49 9342 808-0

Fax: +49 9342 808-5555



E-Mail: info@vacuubrand.com

Web: www.vacuubrand.com

VACUUBRAND®

9.8 CU Certificate

CU Certificate

<h1>Certificate</h1>		 TÜVRheinland®
Certificate no.		CU 72228817 01
License Holder: VACUUBRAND GMBH + CO KG Alfred-Zippe-Str. 4 97877 Wertheim Deutschland	Manufacturing Plant: VACUUBRAND GMBH + CO KG Alfred-Zippe-Str. 4 97877 Wertheim Deutschland	
Test report no.: USA- 31880183 003	Client Reference: Dr. A. Wollschläger	
Tested to: UL 61010-1:2012 R7.19 CAN/CSA-C22.2 NO. 61010-1-12 + GI1 + GI2 (R2017) + A1		
Certified Product: Measurement and control device for vacuum	License Fee - Units	
Model : (1) VACUU VIEW; (2) VACUU VIEW extended;	7	
Designation : (3) VACUU SELECT; (4) VACUU SELECT complete;		
(5) VACUU SELECT Sensor;		
(6) VSP 3000; (7) CVC 3000; (8) VSK 3000;		
(9) VSK PV; (10) DCP 3000		
Rated Voltage: DC 24V; class III (all devices)		
Rated Power : (1+2) 1.3W; (3) 5.0W; (4) 13W; (5) 1.2W;		
(6) 1.6W; (7+10) 3.4W; (8+9) 0.12W		
Degree of : (7+10) IP20/Type 1 (UL50E)		
Protection : (3+4) IP40/Type 1 (UL50E)		
(5) IP41/Type 2 (UL50E)		
(1+2+6+8+9) IP54/Type 5 (UL50E)		
Appendix: 1, 1-13	7	
Licensed Test mark:	Date of Issue (day/mo/yr) 09/02/2023	
 C US	<small>TUV Rheinland of North America, Inc., 12 Commerce Road, Newtown, CT 06470, Tel (203) 426-0888 Fax (203) 426-4009</small>	

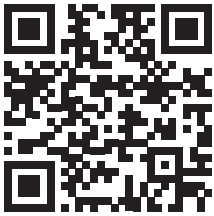
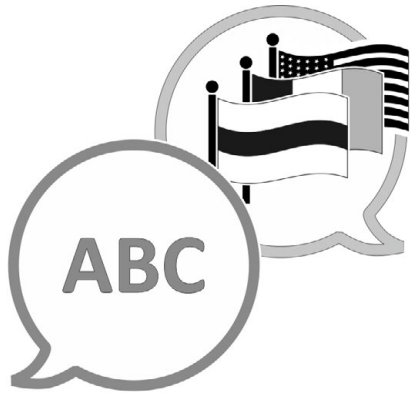

[VACUUBRAND > Support > Manuals](#)

Manufacturer:

VACUUBRAND GMBH + CO KG
Alfred-Zippe-Str. 4
97877 Wertheim
GERMANY

Phone:

Head office +49 9342 808-0
Sales +49 9342 808-5550
Service +49 9342 808-5660

Fax: +49 9342 808-5555

Email: info@vacuubrand.com

Web: www.vacuubrand.com