



Technology for Vacuum Systems

Instructions for use



MD 4 VARIO select - MV 2 VARIO select

Speed controlled diaphragm pumps



Dear customer,

Your VACUUBRAND diaphragm pumps are designed to provide you with many years of trouble-free service with optimal performance. Our many years of practical experience allow us to provide a wealth of application and safety information. Please read these instructions for use before the initial operation of your pump.

VACUUBRAND diaphragm pumps combine our many years of experience in design, construction and practical operation, with the latest developments in material and manufacturing technology.

Our quality maxim is the "zero defect" principle:

Every diaphragm pump, before leaving our factory, is tested intensively, including an endurance run of 14 hours. Any faults, even those which occur rarely, are identified and can be eliminated immediately.

After completion of the endurance run, every pump is tested, and must achieve specifications before shipment.

We are committed to providing our customers only pumps that meet this high quality standard.

While our pumps cannot eliminate all of your work, we design, manufacture and test them to ensure that they will be an effective and trouble-free tool to assist you in that work.

Yours,

VACUUBRAND GMBH + CO KG

After sales service:

Contact your local dealer or call +49 9342 808-5500.

Trademark index:

VACUU·LAN® (US-Reg.No 3,704,401), VACUU·BUS®, VACUU·CONTROL®, VACUU·SELECT® (US-Reg.No 5,522,260), VARIO® (US-Reg.No 3,833,788), VACUUBRAND® (US-Reg.No 3,733,388), VACUU·VIEW®, GREEN VAC® (US-Reg.No. 4,924,553), VACUU·PURE® (US-Reg.No. 5,559,614) and also the shown company logos are registered trademarks of VACUUBRAND GMBH + CO KG in Germany and/or other countries.

DE

Achtung: Die vorliegende Betriebsanleitung ist nicht in allen EU-Sprachen verfügbar. Der Anwender darf die beschriebenen Geräte nur dann in Betrieb nehmen, wenn er die vorliegende Anleitung versteht oder eine fachlich korrekte Übersetzung der vollständigen Anleitung vorliegen hat. Die Betriebsanleitung muss vor Inbetriebnahme der Geräte vollständig gelesen und verstanden werden, und alle geforderten Maßnahmen müssen eingehalten werden.  "Sicherheitshinweise für Vakuumgeräte"

EN

Attention: This manual is not available in all languages of the EU. The user must not operate the device if he does not understand this manual. In this case a technically correct translation of the complete manual has to be available. The manual must be completely read and understood before operation of the device and all required measures must be applied.  "Safety instructions for vacuum equipment"

FR

Attention: Le mode d'emploi présent n'est pas disponible dans toutes les langues d'Union Européenne. L'utilisateur ne doit mettre le dispositif en marche que s'il comprend le mode d'emploi présent ou si une traduction complète et correcte du mode d'emploi est sous ses yeux. Le dispositif ne doit pas être mis en marche avant que le mode d'emploi ait été lu et compris complètement et seulement si le mode d'emploi est observé et tous les mesures demandées sont prises.

 «Avis de sécurité pour des dispositifs à vide»

BG

Внимание: Тези инструкции не са преведени на всички езици от ЕО. Потребителят не бива да работи с уреда, ако не разбира инструкциите за ползване. В този случай е необходимо да бъде предоставен пълен технически превод на инструкциите за ползване. Преди работа с уреда е задължително потребителят да прочете изцяло инструкциите за работа.

 "Указания за безопасност за вакуумни уреди"

CN

注意：该操作手册不提供所有的语言版本。操作者在没有理解手册之前，不能操作该设备。在这种情况下，需要有一个整个操作手册技术上正确的翻译。在操作该设备前，必须完全阅读并理解该操作手册，必须实施所有需要的测量。

 真空设备的安全信息

CZ

Upozornění :Tento návod k použití není k dispozici ve všech jazycích Evropské unie. Uživatel není oprávněn požit přístroj pokud nerozumí tomuto návodu. V takovém případě je nutno zajistit technicky korektní překlad manuálu do češtiny. Návod musí být uživatelem prostudován a uživatel mu musí plně porozumět před tím než začne přístroj používat. Uživatel musí dodržet všechna příslušná a požadovaná opatření.  "Bezpečnostní upozornění pro vakuové přístroje".

DA

Bemærk: Denne manual foreligger ikke på alle EU sprog. Brugeren må ikke betjene apparatet hvis manualen ikke er forstået. I det tilfælde skal en teknisk korrekt oversættelse af hele manual stilles til rådighed. Manual skal være gennemlæst og forstået før apparatet betjenes og alle nødvendige forholdsregler skal tages.

 »Sikkerhedsregler for vakuumdstyr«

EE

Tähelepanu! Käesolev kasutusjuhend ei ole kõigis EL keeltes saadaval. Kasutaja ei tohi seadet käsitseda, kui ta ei saa kasutusjuhendist aru. Sel juhul peab saadaval olema kogu kasutusjuhendi tehniliselt korrektne tõlge. Enne seadme kasutamist tuleb kogu juhend läbi lugeda, see peab olema arusaadav ning kõik nõutud meetmed peavad olema rakendatud.  "Ohutusnõuded vaakumseadmetele"

ES

Atención: Este manual no está disponible en todos los idiomas de UE. El usuario no debe manejar el instrumento si no entiende este manual. En este caso se debe disponer de una traducción técnicamente correcta del manual completo. El manual debe ser leído y entendido completamente y deben aplicarse todas las medidas de seguridad antes de manejar el instrumento.  "Notas sobre la seguridad para equipos de vacío"

FI

Huomio: Tämä käyttöohje ei ole saatavilla kaikilla EU: n kielillä. Käyttäjä ei saa käyttää laitetta, jos hän ei ymmärrä tätä ohjekirjaa. Tässä tapauksessa on saatavilla oltava teknisesti oikein tehty ja täydellinen ohjekirjan käännös. Ennen laitteen käyttöä on ohjekirja luettava ja ymmärrettävä kokonaan sekä suoritettava kaikki tarvittavat valmistelut ja muut toimenpiteet.  "Vakuumlaitteen turvallisuustiedot"

GR

Προσοχή! : Οι οδηγίες αυτές δεν είναι διαθέσιμες σε όλες τις γλώσσες της Ευρωπαϊκής Ένωσης. Ο χρήστης δεν πρέπει να θέσει σε λειτουργία την συσκευή αν δεν κατανοήσει πλήρως τις οδηγίες αυτές. Σε τέτοια περίπτωση ο χρήστης πρέπει να προμηθευτεί ακριβή μετάφραση του βιβλίου οδηγιών. Ο χρήστης πρέπει να διαβάσει και να κατανοήσει πλήρως τις οδηγίες χρήσης και να λάβει όλα τα απαραίτητα μέτρα πριν θέσει σε λειτουργία την συσκευή.  "Υποδείξεις ασφάλειας για αντλίες κενού"

HR

Pažnja: ove upute ne postoje na svim jezicima Europske Unije. Korisnik nemora raditi sa aparatom ako ne razumije ove upute. U tom slučaju tehnicki ispravni prijevod cijelih uputstava mora biti na raspolaganju. Uputstva moraju biti cijela procitana i razumljiva prije rada sa aparatom i sve zahtijevane mjere moraju biti primjenjene.

 "Sigurnosne napomene za vakuumske uređaje"

HU

Figyelem! Ez a kezelési utasítás nem áll rendelkezésre az EU összes nyelvén. Ha a felhasználó nem érti jelen használati utasítás szövegét, nem üzemeltetheti a készüléket. Ez esetben a teljes gépkönyv fordításáról gondoskodni kell. Üzembe helyezés előtt a kezelőnek végig kell olvasnia, meg kell értenie azt, továbbá az üzemeltetéshez szükséges összes mérést el kell végeznie.  "A vákuum-készülékekkel kapcsolatos biztonsági tudnivalók"

IT

Attenzione: Questo manuale non è disponibile in tutte le lingue della Comunità Europea (CE). L'utilizzatore non deve operare con lo strumento se non comprende questo manuale. In questo caso deve essere resa disponibile una traduzione tecnicamente corretta del manuale completo. Il manuale deve essere completamente letto e compreso prima di operare con lo strumento e devono essere applicati tutti gli accorgimenti richiesti.  "Istruzioni di sicurezza per apparecchi a vuoto"

JP

注意：この取扱説明書はすべての言語で利用可能ではありません。もしこの取扱説明書を理解できないならば、ユーザーは装置を操作してはなりません。この場合、技術的に正しい翻訳がなされた完全なマニュアルを用意しなければなりません。装置を作動する前にマニュアルを完全に読み、そして理解されなくてはなりません。そして、すべての要求される対策を講じなければなりません。

 真空装置を安全に取り扱うために

KR

주의: 이 매뉴얼은 모든 언어로 번역되지 않습니다. 만약 이 매뉴얼의 내용을 충분히 인지하지 못했다면 기기를 작동하지 마십시오. 매뉴얼의 내용을 기술적으로 정확하게 번역한 경우에 이용하십시오. 기기를 사용하기 전에 이 매뉴얼을 충분히 읽고 이해하고 모든 요구되는 사항들을 적용해야 합니다.

 진공 장비에 대한 안전 정보

LT

Dėmesio: šis vadovas nėra pateikiamas visomis ES kalbomis. Naudotojui draudžiama eksploatuoti įtaisą, jeigu jis nesupranta šio vadovo. Tokiu atveju reikia turėti viso vadovo techniškai taisyklingą vertimą. Vadovą būtina visą perskaityti ir suprasti pateikiamas instrukcijas prieš pradėdant eksploatuoti įtaisą, bei imtis visų reikiamų priemonių.  "Vakuuminės įrangos saugos informacija"

LV

Uzmanību: Lietotāja instrukcija nav pieejama visās ES valodās. Lietotājs nedrīkst lietot iekārtu, ja viņš nesaprot lietotāja instrukcijā rakstīto. Šādā gadījumā, ir nepieciešams nodrošināt tehniski pareizu visas lietotāja instrukcijas tulkojumu. Pirms sākt lietot iekārtu, un, lai izpildītu visas nepieciešamās prasības, iekārtas lietotāja instrukcija ir pilnībā jāizlasa un jāsaprot.  "Vakuuma iekārtu drošības noteikumi"

NL

Attentie: Deze gebruiksaanwijzing is niet in alle talen van de EU verkrijgbaar. De gebruiker moet niet met dit apparaat gaan werken als voor hem/haar de gebruiksaanwijzing niet voldoende duidelijk is. Bij gebruik van deze apparatuur is het noodzakelijk een technisch correcte vertaling van de complete gebruiksaanwijzing te hebben. Voor het in gebruik nemen van het apparaat moet de gebruiksaanwijzing volledig gelezen en duidelijk zijn en dienen alle benodigde maatregelen te zijn genomen.  "Veiligheidsvoorschriften voor vacuümapparaten"

PL

Uwaga!! Ta instrukcja nie jest dostępna we wszystkich językach Unii Europejskiej. Użytkownik nie może rozpocząć pracy z urządzeniem dopóki nie przeczytał instrukcji i nie jest pewien wszystkich informacji w niej zawartych. Instrukcja musi być w całości przeczytana i zrozumiana przed podjęciem pracy z urządzeniem oraz należy podjąć wszystkie niezbędne kroki związane z prawidłowym użytkowaniem.

 "Wskazówki bezpieczeństwa do urządzeń próżniowych"

PT

Atenção: Este manual não está disponível em todas as línguas da UE. O usuário não deve utilizar o dispositivo, se não entender este manual. Neste caso, uma tradução tecnicamente correta do manual completo tem de estar disponível. O manual deve ser lido e entendido completamente antes da utilização do equipamento e todas as medidas necessárias devem ser aplicadas.  "Informação de Segurança para Equipamento que funciona a Vácuo"

RO

Atentie: Acest manual nu este disponibil in toate limbile EU. Utilizatorul nu trebuie sa lucreze cu aparatul daca nu intelege manualul. Astfel, va fi disponibile o traducere corecta si completa a manualului. Manualul trebuie citit si inteles in intregime inainte de a lucra cu aparatul si a luat toate masurile care se impun.

 "Instrucțiuni de siguranță pentru aparatele de vidare"

RU

Внимание: Эта инструкция по эксплуатации не имеется на всех языках. Потребителю не дозволено эксплуатировать данный прибор, если он не понимает эту инструкцию. В этом случае нужен технически правильный перевод полной инструкции. Прежде чем использовать этот прибор, необходимо полностью прочитать и понять эту инструкцию и принять все необходимые меры.  "Указания по технике безопасности при работе с вакуумными устройствами"

SE

Varning: Denna instruktion är inte tillgänglig på alla språk inom EU. Användaren får inte starta utrustningen om hon/han inte förstår denna instruktion. Om så är fallet måste en tekniskt korrekt instruktion göras tillgänglig. Instruktionen måste läsas och förstås helt före utrustningen tas i drift och nödvändiga åtgärder göres.

 "Säkerhetsinformation för vakuumutrustning"

SI

Pozor: Ta navodila niso na voljo v vseh jezikih EU. Uporabnik ne sme upravljati z napravo, če ne razume teh navodil. V primeru nerazumljivosti mora biti na voljo tehnično pravilen prevod. Navodila se morajo prebrati in razumeti pred uporaba naprave, opravljene pa moraja biti tudi vse potrebne meritve.

 "Varnostni nasveti za vakuumske naprave"

SK

Upozornenie: Tento manuál nie je k dispozícii vo všetkých jazykoch EÚ. Užívateľ nesmie obsluhovať zariadenie, pokiaľ nerozumie tomuto manuálu. V takomto prípade musí byť k dispozícii technicky správny preklad celého manuálu. Pred obsluhou zariadenia je potrebné si prečítať celý manuál a porozumieť mu, a musia byť prijaté všetky opatrenia.  "Bezpečnostné pokyny pre vákuové zariadenia"

TR

Dikkat : Bu kullanım kitabı, tüm dillerde mevcut değildir. Kullanıcı, bu kullanım kitabını anlayamadıysa cihazı çalıştırmamalıdır. Bu durumda, komple kullanım kitabının, teknik olarak düzgün çevirisinin bulunması gerekir. Cihazın çalıştırılmasından önce kullanım kitabının komple okunması ve anlaşılması ve tüm gerekli ölçümlerin uygulanması gerekir.  "Vakumlu cihazlar için güvenlik uyarıları"

The document "Safety information for vacuum equipment" and the instruction for use of the vacuum controller VACUU·SELECT® are part of this manual!

Read the "Safety information for vacuum equipment" and observe the instructions contained therein!

Apart from a short description of the VACUU·SELECT® operating panel, this manual describes the mechanical structure of the diaphragm pump.

Operation of the VACUU·SELECT® vacuum controller and its functions are described in the separate VACUU·SELECT® manual.

Contents

Safety information!	11
Important information!	11
General information	13
Intended use.....	13
Setting up and installing the equipment	14
Ambient conditions	17
Operating conditions	17
Safety during operation	19
Maintenance and repair.....	22
⚠ Important information: Equipment marking (ATEX).....	24
Technical data	26
General technical data valid for all pumps	26
Gas inlet temperatures	27
Wetted parts	30
Abbreviations.....	30
Pump parts	31
VACUU•SELECT parts.....	33
Use and operation	36
Installing a pump in a vacuum system	36
VACUU•SELECT Controller	38
During operation.....	42
Shutdown & storage.....	44
Readjustment of vacuum sensor	45
Calibration in the factory	47
Cleaning the pressure transducer	48
Accessories	49
Troubleshooting	50
Replacing diaphragms and valves	53
Cleaning and inspecting the pump heads	55
Replacing the diaphragm	56
Assembling the pump heads	58
Replacing the device fuse	60

Repair - Maintenance - Return - Calibration	61
Warranty	63
Health and safety clearance form	64
Declarations and certificates.....	65
China RoHS.....	67

Safety information!

Important information!

WARNING

- ☞ **Keep this manual complete and accessible to personnel at all times!**
- ☞ **Read this manual carefully before installing or operating the equipment. Observe the instructions contained in this manual.**

- ☞ **Do not modify the equipment without authorization.**

NOTICE

This manual is an integral part of the equipment described therein. It describes the safe and proper use of the vacuum pump.

Make operating personnel aware of dangers arising from the pump and the pumped substances.

VACUUBRAND disclaims any liability for inappropriate use of these pumps and for damage from failure to follow instructions contained in this manual.

This manual is only to be used and distributed in its complete and original form. It is strictly the users' responsibility to check carefully the validity of this manual with respect to his product.

Manual-no.: 20901106

The following signal word panels and safety symbols are used throughout this manual:



This is the safety alert symbol. It is used to alert you to potential personal injury hazards. Obey all safety messages that follow this symbol to avoid possible injury and death.



➔ DANGER indicates a hazardous situation which, if not avoided, will result in death or serious injury.



☞ WARNING indicates a hazardous situation which, if not avoided, could result in death or serious injury.



• CAUTION indicates a hazardous situation which, if not avoided, could result in minor or moderate injury.



NOTICE is used to address practices not related to personal injury.



Caution! Hot surface!



Disconnect equipment from AC power.



Electronic components must not be disposed of in the domestic waste at the end of their service life. Used electronic devices contain harmful substances that can cause damage to the environment or human health. End users are legally obliged to take used electric and electronic devices to a licensed collection point.

Formatting used in this manual:

Note: The signal word panels in all sections of this manual always refer to all paragraphs of the same format (➔ / ☞ / • / plain text) following each signal word panel.

General information

NOTICE

Remove all packing material from the packing box. Remove the product from its packing-box and retain all packaging until the equipment is inspected and tested. Remove the protective caps from the inlet and outlet ports and retain for future use. Inspect the equipment promptly and carefully.

If the equipment is damaged, notify the supplier and the carrier in writing within three days. Retain all packing material for inspection. State the item number of the product together with the order number and the supplier's invoice number. Failure to check and give notice of damage will void any and all warranty claims for those deficiencies.

Replace the protective caps, if the equipment is not used immediately. Store the equipment in dry and non-corrosive conditions (see also "Technical data", pg. 26).

WARNING

☞ **Do not use any damaged equipment.**

CAUTION

- Use the recessed grips when moving the pump.

Intended use

WARNING

☞ Do not use the pump or any system parts on humans or animals.

☞ Ensure that the individual components are only connected, combined and operated according to their design and as indicated in the instructions for use. Use only **original manufacturer's spare parts and accessories**. Otherwise the safety and performance of the equipment, as well as the electromagnetic compatibility of the equipment might be reduced.

The CE mark or the cTÜVus mark (see rating plate) may be voided if not using original manufacturer's spare parts.

- ☞ Comply with all notes on correct vacuum and electrical connections; see section “Use and operation”, pg. 36.
- ☞ Do not use the pump to generate pressure.
- ☞ The pumps are designed for **ambient temperatures** during operation between +50°F and +104°F (+10°C and +40°C). Periodically check maximum temperatures if installing the pump in a cabinet or a housing. Make sure ventilation is adequate to maintain recommended operating temperature. Install an external automatic ventilation system if necessary. If pumping hot process gases, make sure that the maximum permitted gas inlet temperature is not exceeded. The maximum permitted gas inlet temperature depends on several parameters like inlet pressure and ambient temperature (see “Technical data”, pg. 26).
- ☞ Particles and dust must not enter the pump.
- ☞ Do not pump liquids.

CAUTION

- Ensure that the pump is chemically resistant to the pumped substances prior to operation.

NOTICE

Use the equipment **only as intended**, that is, for generation, measurement, and control of vacuum in vessels designed for that purpose. The equipment may only be used indoors in a non-explosive atmosphere.

Any other use will automatically invalidate all warranty and liability claims. Remain aware of safety and risks.

Setting up and installing the equipment

DANGER

- ➔ Equipment must be connected only to a **suitable electrical supply** and a suitable ground point. As such, the plug must be plugged into an outlet that is properly grounded. Failure to connect the motor to ground may result in deadly electrical shock.

The supply cable may be fitted with a molded European IEC plug or a plug suitable for your local electrical supply. The cable contains wires color coded as follows: green or green and yellow: ground; blue or white: neutral; brown or black: hot.

⚠ WARNING

- ☞ Due to the high compression ratio, the pump may generate overpressure at the outlet. Check pressure compatibility with system components (e.g., exhaust pipeline or exhaust valve) at the outlet.
- ☞ Do not permit any **uncontrolled pressurizing**. Make sure that the exhaust pipeline cannot become blocked. If there is an exhaust isolation valve, make sure that you cannot operate the equipment with the valve closed to avoid a **risk of bursting!**
- ☞ Maximum permissible pressure at the pressure transducer: 21.8 psi (1.5 bar) absolute.
- ☞ Keep the electrical power cord away from heated surfaces.
- ☞ Keep the electrical power cord away from hot surfaces.

⚠ CAUTION

- Provide a firm, level platform for the equipment. Check that the system which you are going to evacuate is mechanically stable. Check that all fittings are secure. Ensure a stable position of the pump without any mechanical contact other than the pump feet.
- Comply with **maximum permissible pressures** at inlet and outlet and with **maximum permissible pressure differences** between inlet and outlet. See section “Technical data”, pg. 26. Do not operate the pump with overpressure at the inlet.
- Comply with **maximum permissible pressures** at the pressure transducer. See section “Technical data”, pg. 26.

- Avoid overpressure of more than 17.5 psi absolute (1.2 bar absolute) in the event that gas or inert gas is connected to the pump, or to a venting valve.
- **Note:** Flexible elements will shrink when evacuated.
- Connect hoses gas tight at inlet and outlet of the pump.
- Connect hoses gas tight at the pressure transducer.
- Ensure that no foreign objects can be drawn into the pump.
- Check the power source and the pump's rating plate to be sure that the power source and the equipment match in voltage, phase, and frequency.

NOTICE

Make sure ventilation is adequate to maintain recommended operating temperature. Keep a minimum distance of 2 in (5 cm) between the cooling fan and surrounding items (e.g., housing, walls, etc.), or else install an external automatic ventilation system. Check fan regularly for dust/dirt. Clean fan guard grill if necessary to avoid a reduction of ventilation.

The mains plug is a disconnecting device to separate the pump from the supply voltage. Ensure that the mains plug is easily accessible at all times to allow the separation of the device from the power supply.

Position the pressure transducer and its vacuum line in such a way that condensate cannot flow towards the pressure transducer.

Use only hoses at the inlet and outlet of the pump with an inner diameter at least as large as the diameter of the pump's tubing (to avoid overpressure at the outlet, and reduction of pumping speed at the inlet).

Allow the equipment to equilibrate to ambient temperature if you bring it from cold environment into a room prior to operation. Notice if there is water condensation on cold surfaces.

Comply with all **applicable and relevant safety requirements** (regulations and guidelines). **Implement the required actions and adopt suitable safety measures.**

Ambient conditions

! DANGER

- ➔ Do not reach for this product if it has fallen into liquid. There is a risk of deadly electrical shock. Unplug the system immediately.

! WARNING

- ☞ Do not use this product in an area where it can fall or be pulled into water or other liquids.

! CAUTION

- This product may only be used indoors in a non-explosive atmosphere, and in a dry environment. Adopt suitable measures in case of differences from recommended conditions, e.g., installation in higher altitudes (risk of insufficient cooling), conductive pollution or external condensation on the pump.
- Do not operate this product near flames.

NOTICE



To the best of our knowledge the equipment is in compliance with the requirements of the applicable EC-directives and harmonized standards (see "Declaration of Conformity") with regard to design, type and model. Directive EN 61010-1 gives in detail the conditions under which the equipment can be operated safely (see also IP degree of protection, "Technical data", pg. 26).

Operating conditions

! DANGER

- ➔ These pumps are not approved for operation in potentially explosive atmospheres. **Do not operate the pumps in potentially explosive atmospheres.**
- ➔ Pumps **without the**  **mark on the rating plate are not approved for the pumping of potentially explo-**

sive atmospheres. Do not pump potentially explosive atmospheres with those pumps

- ➔ Pumps bearing the “” mark on their rating plates are **approved for the pumping of potentially explosive atmospheres** according to their ATEX classification imprinted on their rating plate, but they are **not approved for operation in potentially explosive atmospheres** (see section “ Important information: Equipment marking (ATEX)”, pg. 24).
- ➔ The pumps are **not suitable** to pump any of the substances listed below.

Do not pump:

- **unstable substances**
 - substances which react explosively under **impact** (mechanical stress) without air
 - substances which react explosively when being exposed to **elevated temperatures** without air,
 - substances subject to **auto-ignition**,
 - substances which are **flammable without air**
 - **explosive substances**.
- ➔ The pumps are **not approved** for operation below ground. **Do not operate** the pump **below ground**.



- **Do not pump** substances which may form **deposits** inside the pump. The pumps are not suitable for pumping substances which may form deposits inside the pump. Deposits and condensate in the pump may lead to increased temperatures even to the point of exceeding the maximum permitted temperatures.
- Check the inlet and outlet of the pump, if there is a danger of forming **deposits** inside the pump, e.g., in the pump chambers (the pump chamber is the part between diaphragm and head cover. See section “Replacing diaphragms and valves”, pg. 53). Inspect the pump chambers regularly and clean if necessary.

- **Consider interactions and chemical reactions of the pumped media.** Ensure that the materials of the pump's wetted parts are compatible with the pumped substances, see section "Technical data", pg. 26. When changing the substances pumped, we recommend purging the pump with air or inert gas prior to changing the pumped media. Purging the pump will pump out residues and it will reduce the possibility of reactions of the pumped substances with each other and with the pump's materials.

Safety during operation

! DANGER

- ➔ Adopt suitable measures to prevent the release of dangerous, toxic, explosive, corrosive, noxious or polluting fluids, vapors and gases. To prevent any emission of such substances from the pump outlet, install an appropriate collecting and disposal system and take protective action for pump and environment.
- ➔ You must take suitable precautions to prevent any formation of explosive mixtures in the pump chamber or at the outlet of the pump. In case, e.g., of a diaphragm failure, mechanically generated sparks, hot surfaces or static electricity may ignite these mixtures. Use inert gas for venting, if necessary.
- ➔ Drain appropriately or otherwise remove any potentially explosive mixtures at the outlet of the pump, or dilute them to non-explosive concentrations.
- ➔ Never operate this pump if it has a damaged cord or plug.

! WARNING

- ☞ If the pump is not working properly, has been dropped or has fallen into water, contact your pump service provider.
- ☞ Prevent any part of the human body from coming into contact with vacuum.

- ☞ Make sure that the exhaust pipeline cannot become blocked.
- ☞ **Attention:** At pressures above approximately 810 Torr (1080 mbar) the pressure reading becomes incorrect. The display flashes and a warning message is displayed. Release pressure immediately! Risk of bursting!
- ☞ Comply with applicable regulations when disposing of chemicals. Take into consideration that chemicals may be contaminated. Take adequate precautions to protect people from the effects of dangerous substances (chemicals, thermal decomposition products of fluoroelastomers). Use appropriate protective clothing and safety goggles.
- ☞ Interruption of the pump (e.g., due to power failure), failure of connected components or of parts of the supply, or change in parameters must not be allowed to lead to dangerous conditions. In case of a diaphragm failure or in case of a leak in the manifold, pumped substances might be released into the environment or into the pump housing or motor.
Comply with all notes regarding proper use of the pumps, as well as operation and maintenance guidance.
- ☞ The residual **leak rate of the equipment** might render possible an exchange of gas, albeit extremely slight, between the environment and the vacuum system.
Adopt suitable measures to prevent contamination of the pumped substances or the environment.



- Ensure that no parts of your clothing, hair or fingers can be caught or drawn in at the inlet of the pump. Never insert fingers or drop any other object into the inlet or outlet.

- You must take suitable precautions to prevent any dangerous situation from arising if the controller starts the VARIO pump, switches a coolant valve or opens a venting valve.
- **Attention:** If the controller is set to **Autostart**, the process will start immediately when switching on the device or in case of power recurrence after a power failure. It is your responsibility to ensure that automatic start-up of the system will not lead to any dangerous condition. Provide appropriate safety measures. Check **prior to starting the process** whether the option "*Autostart*" (menu: Settings\Basic Settings) is enabled.



- Pay attention to the safety symbol "hot surfaces" on the equipment. Depending on operation conditions and ambient conditions dangers due to hot surfaces may arise. Hot parts may cause burns if touched. Adopt suitable measures to prevent any danger arising from hot surfaces. Ensure that hot surfaces of the pump do not cause burns. Provide a suitable contact guard if necessary.

NOTICE

Prevent the backpressure of gases and the backflow of condensates at the outlet.

Provide appropriate protective measures to allow for the possibility of failure and **malfunction**. The protective measures must also allow for the requirements of the respective application.

In case of overload, the motor is shut down by a **self-hold thermal cutout** in the winding.

Note: Only manual reset is possible. Acknowledge the error message at the controller. Switch off the pump and disconnect from the power source. Identify and eliminate the cause of failure. Wait approx. five minutes before re-starting the pump.

Maintenance and repair

NOTICE

In order to comply with laws (occupational, health and safety regulations, safety at work law and regulations for environmental protection) vacuum pumps, components and measuring instruments can only be returned when certain procedures (see section "Repair - Maintenance - Return - Calibration", pg. 61) are followed.

Take advantage of our service seminars, which put special focus on the maintenance and repair of vacuum pumps. For details and for the online "Instructions for repair" manual see www.vacuubrand.com.

In normal use, the lifetime of the diaphragms and valves is typically 15,000 operating hours. Bearings have a typical durability of 40000 h.

DANGER



- ➔ **Ensure that the pump cannot be operated accidentally. Never operate the pump if covers or other parts of the pump are disassembled.**
- ➔ **Switch off the pump. Disconnect the electrical power cord and wait two minutes** before starting maintenance to allow the capacitors to discharge.
- ➔ **Note:** The pump may be contaminated with process chemicals, which have been pumped during operation. Ensure that the pump is completely decontaminated before maintenance commences.

WARNING

- ☞ Take adequate precautions to protect people from the effects of dangerous substances if contamination has occurred. Use appropriate protective clothing, safety goggles and protective gloves.
- ☞ **Wear parts have to be replaced regularly.**
- ☞ **Never operate a defective or damaged pump.**
- ☞ Vent the pump before starting maintenance. Isolate the pump and other components from the vacuum system.

Allow sufficient cooling of the pump.

NOTICE

Clean polluted surface with a clean, slightly moistened cloth. To moisten the cloth we recommend water or mild soap.

Ensure that **maintenance** is done only by suitably trained and supervised technicians. Ensure that the maintenance technician is familiar with the safety procedures which relate to the products processed by the pumping system. Only dismantle the pump as far as necessary.

Important information: Equipment marking (ATEX)

Only valid for products with ATEX marking. If the ATEX marking is shown on the rating plate of the respective product, VACUUBRAND GMBH + CO KG assures, that the device complies with the provisions of the directive 2014/34/EU. The applied harmonized standards are indicated in the EC Declaration of Conformity of the Machinery (see instructions for use).

VACUUBRAND equipment bearing the ATEX mark (see rating plate)

The classification according to ATEX is only valid for the inner part (wetted part, pumped gas or vapor) of the equipment. The equipment is not suitable for use in external, potentially explosive atmospheres (environment).

The overall category of the equipment depends on the connected components. If the connected components do not comply with the classification of the VACUUBRAND equipment, the specified category of the VACUUBRAND equipment is no longer valid.

Vacuum pumps and vacuum gauges in category 3 are intended for connection to equipment in which during normal operation explosive atmospheres caused by gases, vapors or mists normally don't occur; or, if they do occur, are likely to do so only infrequently and for a short period only. Equipment in this category ensures the requisite level of protection during normal operation.

The use of gas ballast or the operation of venting valves is only permitted if thereby explosive atmospheres normally don't occur in the interior of the equipment or, if they do occur, are likely to do so only infrequently and for a short period.

The pumps are marked with "X" (according to DIN EN ISO 80079-36:2016), i.e., restrictions of the operation conditions:

- The equipment is designated for a low degree of mechanical stress and has to be installed in a way so that it cannot be damaged from outside.
Pumping units have to be installed so that they are protected against shocks from the outside and against glass splinters in the event of breakage (implosion).
- The equipment is designated for an ambient and gas inlet temperature during operation of +10 to +40°C. Never exceed these ambient and gas inlet temperatures. If pumping / measuring gases which are not potentially explosive, extended gas inlet temperatures are permissible. See instructions for use, section “Gas inlet temperatures” or “Technical data”.

After any intervention at the equipment (e.g., repair / maintenance) the ultimate vacuum of the pump has to be checked. Only if the pump achieves its specified ultimate vacuum is the pump's leak rate low enough to ensure that no explosive atmospheres will occur in the interior of the equipment.

After any intervention at the vacuum sensor, the leak rate of the equipment has to be checked.



Attention: This manual is not available in all languages of the EU. The user must not operate the device if he does not understand this manual. In this case a technically correct translation of the complete manual has to be available. The manual must be completely read and understood before operation of the device. All specified measures must be applied, or else must be replaced by equivalent measures at the user's own risk.

Technical data

General technical data valid for all pumps		
ATEX approval if the ATEX marking is shown on the rating plate Inner part (pumped gases)		II 3/- G Ex h IIC T3 Gc X Internal Atm. only Tech.File: VAC-EX02
Maximum permissible inlet pressure (absolute)	psi (bar)	16 (1.1)
Maximum permissible outlet pressure (absolute)	psi (bar)	16 (1.1)
Maximum pressure difference between inlet and outlet	psi (bar)	16 (1.1)
Permissible ambient temperature storage / operation	°F (°C)	14 to 140 / 50 to 104 (-10 to +60 / +10 to +40)
Permissible relative atmospheric moisture during operation (no condensation)	%	30 to 85
Maximum permissible installation altitude above mean sea level	ft (m)	6500 (2000)
Rated motor power	hp (kW)	0.71 (0.530)
No-load speed 50/60 Hz	rpm	30 - 2400
Device fuse		100-120V: slow blow fuse 8A 200-230V: slow blow fuse 4A
Motor protection		thermal cutout, manual reset
Overvoltage category		II
Degree of protection IEC 60529		IP 20
Degree of protection UL 50E		type 1
Pollution degree		2

Type		MD 4 VARIO select	MV 2 VARIO select
Maximum pumping speed 50/60 Hz (ISO 21360)	cfm (m ³ /h)	3.4 (5.7)	1.9 (3.3)
Ultimate vacuum (absolute) *	Torr (mbar)	0.75 (1.0)	0.2 (0.3)
Maximum permissible range of supply voltage (±10%) Attention: Observe specifications of rating plate!		100-120 V~ 50/60 Hz	
		200-230 V~ 50/60 Hz	
Maximum rated current at: 100-120 V~ 50/60 Hz 200-230 V~ 50/60 Hz	A A	6.3 2.5	
Inlet		small flange DN 16	
Outlet		silencer	
A-weighted emission sound pressure level** (uncertainty K _{pA} : 3 dB(A))	dB(A)	45	
Dimensions L x W x H approx.	in (mm)	12.8 x 9.3 x 9.6 (325 x 235 x 245)	
Weight approx.	lbs. (kg)	42.1 (19.1)	

* Ultimate vacuum at setting "Pump down" with optimized speed close to the ultimate vacuum

** Measurement according to EN ISO 2151:2004 and EN ISO 3744:1995 at 1500rpm and ultimate vacuum with standard silencer at outlet.

Gas inlet temperatures

Operating condition	Inlet pressure	Permitted range of gas temperatures at inlet
Continuous operation	> 75 Torr (100 mbar) (high gas load)	➔ 50 °F to 104 °F (+10°C to +40°C)
Continuous operation	< 75 Torr (100 mbar) (low gas load)	➔ 32 °F to 140 °F* (0°C to +60°C*)
Short-time (< 5 minutes)	< 75 Torr (100 mbar) (low gas load)	➔ 14 °F to 176 °F* (-10°C to +80°C*)

* if pumping potentially explosive atmospheres: 50 °F to 104 °F (+10°C to +40°C)

Controller	VACUU•SELECT with VACUU•SELECT Sensor
Pressure transducer	VACUU•SELECT Sensor; external gauge head, capacitive, ceramic diaphragm (alumina), absolute pressure, gas type independent
Display	color display with touchscreen
Pressure units / scale (selectable)	Torr, mbar or hPa
Measuring range (absolute)	810 - 0.1 Torr (1080 - 0.1 mbar)
Maximum control range (absolute)*	810 - 0.1 Torr (1080 - 0.1 mbar)
Maximum permissible pressure at pressure transducer (absolute)	1125 Torr (1.5 bar)
Temperature coefficient	< 0.11 Torr/K (0.15 mbar/K)
Measurement uncertainty (absolute) after careful adjustment and at constant temperature	± 1 Torr/mbar/hPa, ± 1 digit
Maximum permissible temperature of gaseous media**	continuous operation: 104°F (40°C), for short periods (less than 5 minutes) up to 176°F (80°C)
Ambient temperature range (operation)	50 °F to 104 °F (10 °C to +40 °C)
Ambient temperature range (storage)	14 °F to 140 °F (-10 C to +60 °C)
Permissible relative atmospheric mois- ture during operation (no condensation)	30% to 85%
Maximum permitted current of connect- ed valves (connected components)	4A
Degree of protection IEC 60529 (controller)	IP 40
Degree of protection IEC 60529 (front side controller)	IP 42
Degree of protection IEC 60529 (sensor)	IP 42
Measurement connection of pressure transducer	small flange DN 16 or hose nozzle DN 6/10 or hose connection PTFE hose DN 8/10
Cable length of sensor	approx. 5'6" (2m)
Plug-in connector	VACUU • BUS

* The actual vacuum control range in your application might be reduced due to ultimate vacuum of the pump, volume of gas present, etc.

** if pumping potentially explosive atmospheres: 50 °F to 104 °F (+10°C to +40°C)

Controller	VACUU•SELECT with VACUU•SELECT Sensor
Cable length of sensor	approx. 5'6" (2m)
Supply voltage (via VACUU • BUS)	24 VDC
Device fuse on circuit board	Nano fuse 4 A/t
Max. power of controller	5 W
Power sensor	0.2 W
Max. switching current (24V / VACUU • BUS)	4 A
Communication	VACUU • BUS
Interfaces	VACUU • BUS Ethernet (LAN): Patch cable min. cat. 5e RJ45 USB port: 2x USB-A 2.0, max. 0.5 A per port
Dimensions controller L x W x H (without stand)	6.0" x 5.0" x 1.6" (152 mm x 127 mm x 41 mm)
Dimensions sensor with small flange with hose nozzle with hose connection	3.0" x 2.1" x 3.2" (77 mm x 53 mm x 81 mm) 3.9" x 2.1" x 3.2" (100 mm x 53 mm x 81 mm) 2.6" x 2.1" x 3.2" (67 mm x 53 mm x 81 mm)
Weight controller	1.3 lbs. (590 g)
Weight sensor with small flange with hose nozzle with hose connection	0.34 lbs. (155 g) 0.32 lbs. (147 g) 0.32 lbs. (145 g)

We reserve the right for technical modification without prior notice!

Wetted parts

Components	Wetted materials
Pump	
Housing cover	Aluminum alloy (AlMgSi0.5 or AlSi12)
Head cover	Aluminum alloy (AlSi12)
Diaphragm clamping disc	Aluminum alloy (AlSi12)
Diaphragm	FPM
Valves	FPM
O-rings	FPM
Connection tube	Aluminum alloy (AlMgSi0.5)
Small flange	Stainless steel
Silencer	Aluminum alloy / silicone
Sensor	
Sensor	Aluminum oxide ceramic, gold-coated (if applicable)
Seal at sensor	Chemically resistant fluoroelastomer
Measurement chamber	PPS
Small flange (measurement connection)	PP
O-ring in small flange (sensor)	FPM
Hose nozzle (measurement connection)	PP

Abbreviations

- FPM:** Fluoroelastomer
PP: Polypropylene
PPS: Polyphenylene sulfide

We reserve the right for technical modification without prior notice!

Pump parts

	Component
1	Diaphragm pump VARIO select
2	Fan
3	Recessed grip
4	Pump rating plate
5	Inlet
6	VACUU•SELECT controller
7	Mains connection
8	ON/OFF switch
9	Outlet (silencer)
10	Fuse holder
11	VACUU•BUS cable to controller
12	Touchscreen of operating panel
13	Stand (extended)
14	VACUU•SELECT sensor with connection options

MD 4 / MV 2 VARIO select (shown: MD 4 VARIO select)

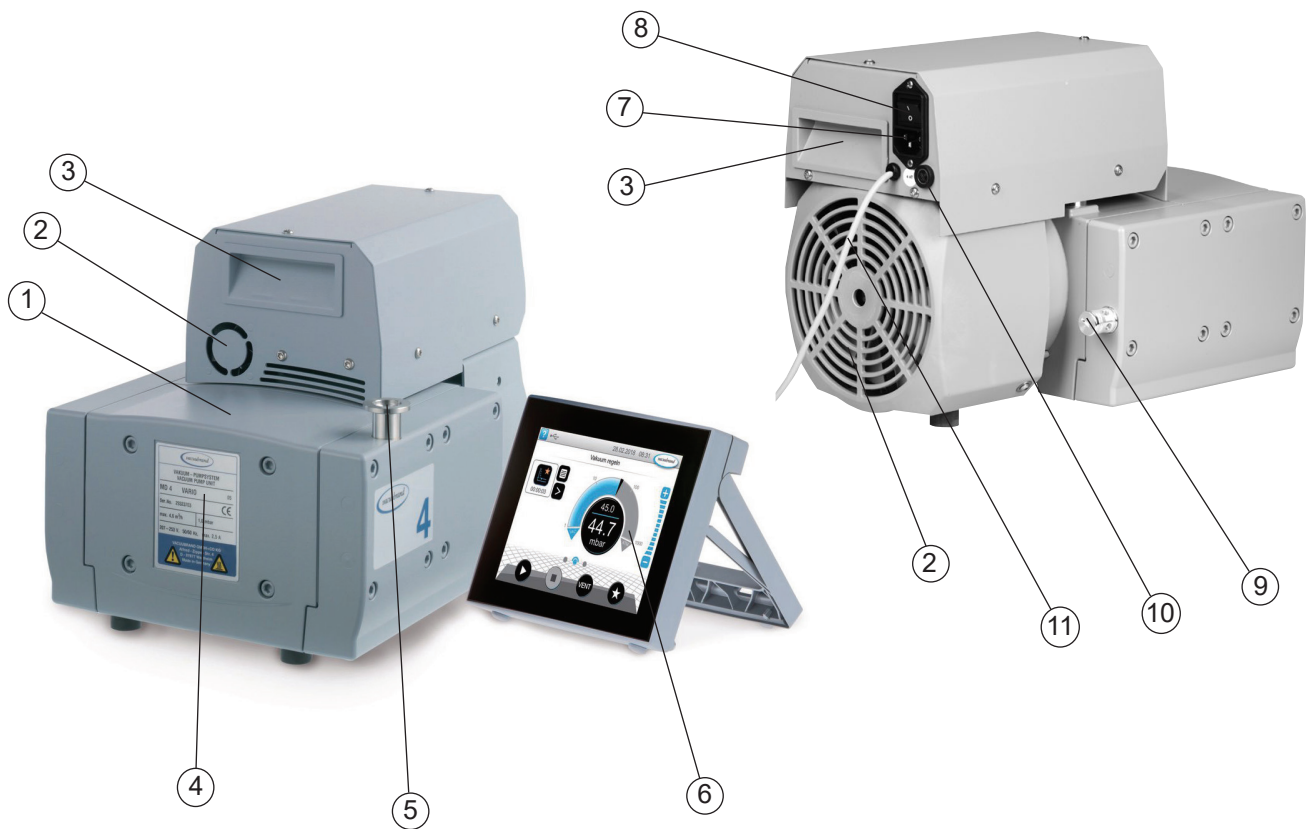

VACUU•SELECT controller (operating panel and sensor)



VACUU·SELECT parts

	Component
1	ON/OFF button
2	Cover of USB port, type A*
3	Screen
4	Chemically resistant plastic housing
5	Rubber feet
6	3x connection sockets for VACUU·BUS® components
7	Recess for VACUU·SELECT® Sensor
8	Power supply via VACUU·BUS®, connection VARIO pump
9	Rating plate
10	Stand, foldable
11	USB port, type A*
12	RJ45 socket – LAN connection

* USB type A is only suitable for connecting USB flash drives or WiFi USB dongles

Operating panel (Top view / Front view / Rear view)

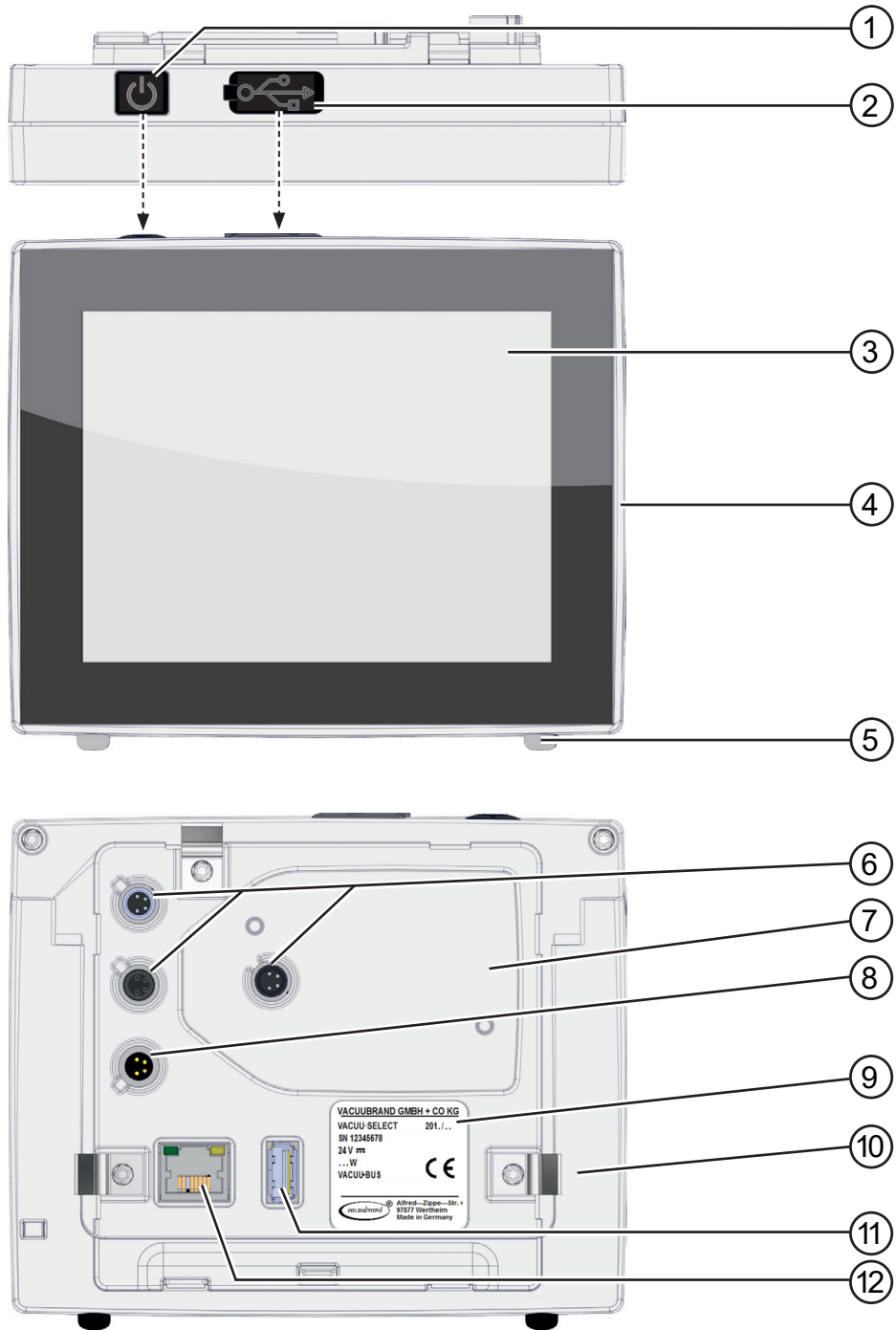

Operating panel (Side view) (extending the stand)

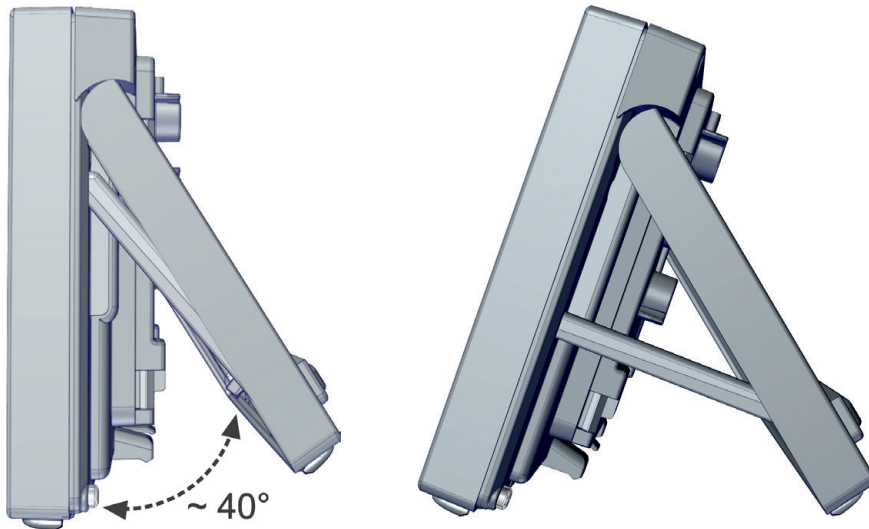

VACUU·SELECT Sensor (Side view / Top view)

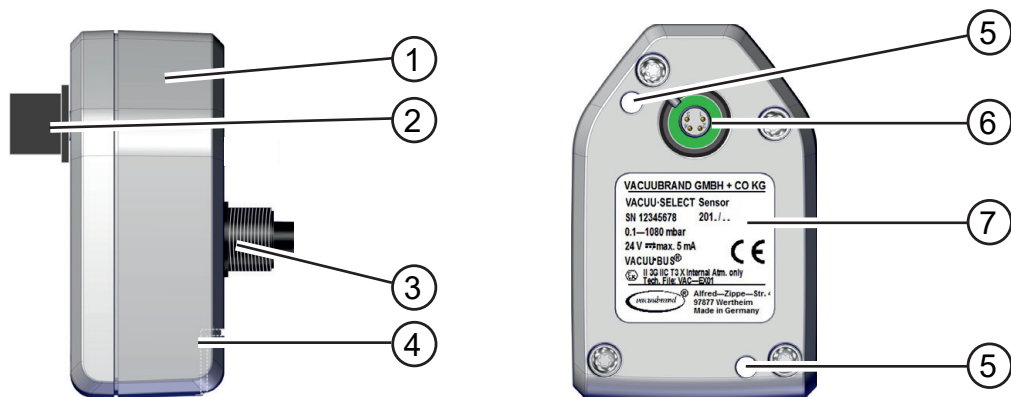

	Component
1	VACUU·SELECT Sensor
2	VACUU·BUS plug attachment, detachable (option)
3	Vacuum screw connection
4	Port for VACUU·BUS® plug attachment (park position)
5	Hole for screws
6	VACUU·BUS port
7	Rating plate

Use and operation

Apart from a short description of the VACUU·SELECT® operating panel, this manual describes the mechanical structure of the diaphragm pump.

Operation of the **VACUU·SELECT® vacuum controller and its functions** are described in the separate **VACUU·SELECT® manual**.

Installing a pump in a vacuum system

! DANGER

- ➔ If dangerous or polluting fluids could be released at the outlet, install an appropriate system to catch and dispose of those fluids.

! WARNING

- ☞ Connect a gas-tight exhaust line at the pump outlet if necessary. Always vent exhaust gases appropriately (e.g., into a fume hood).
- ☞ Never block the gas outlet. The exhaust line must always be free of obstructions (no back pressure) to ensure an unimpeded discharge of gas. The cross-section of the outlet tubing must be at least the size of the pump's exhaust connection.
- ☞ Maximum permissible pressure: 21.8 psi (1.5 bar) absolute.
- ☞ **Attention:** At pressures above approximately 810 Torr (1080 mbar) the pressure reading becomes incorrect. The display will flash and a warning message will be displayed. Release pressure immediately! Risk of bursting!
- ☞ Particles and dust must not be aspirated. If necessary, you must install appropriate filters. You must ensure their suitability concerning gas flow, chemical resistance and resistance to clogging prior to use.
- ☞ Make sure ventilation is adequate, especially if the pump is installed in an enclosure, or if the ambient temperature is elevated. Provide external ventilation, if necessary.

CAUTION

- Reduce the transmission of vibration. Prevent mechanical load due to rigid pipelines. Insert elastic hoses or flexible elements as couplings between the pump and rigid pipes.
Note: Flexible elements will compress or flatten when evacuated if not designed for use under vacuum.
- Hose connections at the pump inlet must always be gas tight.
- A power failure may cause accidental ventilation of the pump. If this constitutes a potential source of danger, take appropriate safety measures.
- Check the power source and the pump's rating plate to be sure that the power source and the equipment match in voltage, phase, and frequency.

NOTICE

Make sure ventilation is adequate to maintain recommended operating temperature. Keep a minimum distance of 2 in (5 cm) between the cooling fan and surrounding items (e.g., housing, walls, etc.), or else install an external automatic ventilation system.

The mains plug is a disconnecting device to separate the pump from the supply voltage. Ensure that the mains plug is easily accessible at all times to allow the separation of the device from the power supply.

Use connecting hoses with large diameter and keep them as short as possible to avoid flow losses. Locate the pump as closely as possible to the application.

Always install outlet tubing descending from the pump or provide other measures to avoid backflow of condensate towards the pump.

Use a suitable valve to isolate the pump from the vacuum application. This is to allow the pump to warm up before pumping condensable vapors and to clean the pump after use before it is switched off.

When assembling, ensure **vacuum-tightness**. After assembly, check the whole system for leaks.

Secure hose connections at the pump appropriately, e.g., with hose clamps, to protect against accidental detachment.

VACUU·SELECT Controller

Connect the VACUU·SELECT operating panel to the VACUU·BUS cable of the VARIO diaphragm pump.

For proper operation of the VARIO select pump a pressure transducer (e.g., VACUU·SELECT Sensor, etc.) has to be connected to the operating panel.

The VACUU·SELECT Controller can only be operated with components compatible with the VACUUBRAND VACUU·BUS system, (see “Accessories”, pg. 49).

The vacuum controller controls VACUUBRAND VARIO diaphragm pumps and optional coolant and venting valves. Connected components (e.g., venting valves, VACUU·SELECT Sensor, etc.) are automatically identified when switching on the operation panel. Identical components must be configured beforehand, see manual of VACUU·SELECT Controller.

Attention: Do not apply off-axis forces when assembling or removing plug connections! Observe correct orientation of the plug.

To connect further components use VACUU·BUS Y-adapters and extension cables.

NOTICE

Do not use more than one controller within the same VACUU·BUS system.

Several controllers in the same VACUU·BUS system will interfere with each other and result in error messages of the connected components (pumps, valves).

VACUU·SELECT Sensor

The VACUU·SELECT Sensor is equipped with a capacitive pressure transducer with ceramic diaphragm. It measures the actual pressure independently of the gas type, and with reference to the vacuum, i.e., absolute.

Connect the VACUU·SELECT Sensor via the VACUU·BUS cable to the operating panel.

Connect the VACUU·SELECT Sensor via hose or small flange connection to the vacuum application. Do not mount the sensor directly at the pump but close to the application. The cross-section of the tubing should be as large as possible.

Inside a vacuum system where evaporation occurs, e.g., a rotary evaporator, the vacuum is not uniform. For example, a condenser can act as a pump, or the vacuum in the connecting tubing can be higher or lower than in the application itself. This affects the measurement results as well as the control levels. Therefore, carefully choose the position where to connect the sensor.

Position the VACUU·SELECT Sensor and its vacuum line in such a way that condensate cannot flow towards the pressure transducer. Condensate and deposits will affect the measurement results. Clean the pressure transducer, if necessary. See section “Cleaning the pressure transducer”, pg. 48.

Installing the hose nozzle at the VACUU·SELECT Sensor:

Unscrew the small flange. Slip hose nozzle with clamping ring onto the vacuum connection and fasten with union nut.

VACUU·BUS

The VACUU·SELECT controller uses VACUU·BUS protocol to read out the pressure transducer via VACUU·BUS line. Maximum cable length inside buildings: 32yd (30m). VACUU·BUS extension cable 2.2 yd (2 meters): order-no. 20612552.

Operating panel - Process screen

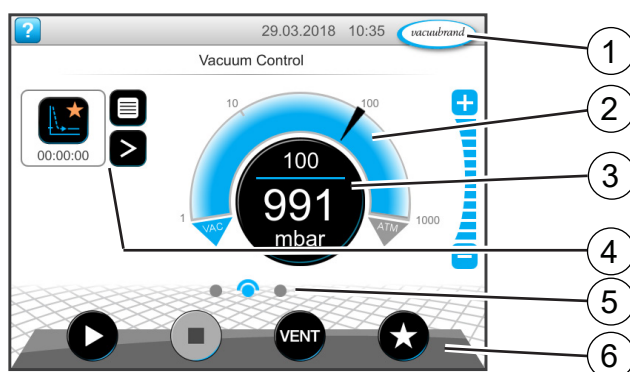

Description	
1	Status bar
2	Analogue pressure display – pressure curve
3	Digital pressure display – pressure value (target value, actual value, pressure unit)
4	Process screen with context features
5	Screen navigation
6	Operating elements for control

Operating panel - Operating elements

Button		Function
Active	Locked	
		Start ▶ Start application – only available on the process screen
		Stop ▶ Stop application – always possible.
		VENT – vent the system (option) ▶ Press button < 2 sec = vent briefly; control continues.
		▶ Press button > 2 sec = vent to atmospheric pressure; vacuum pump is stopped. ▶ Press button during venting = venting is stopped.
		Favorites ▶ View Favorites menu.

* Button is only displayed if venting valve is connected or activated.

Operating panel - Operation

(➔ see manual of VACUU-SELECT Controller)

Start the pump / process:

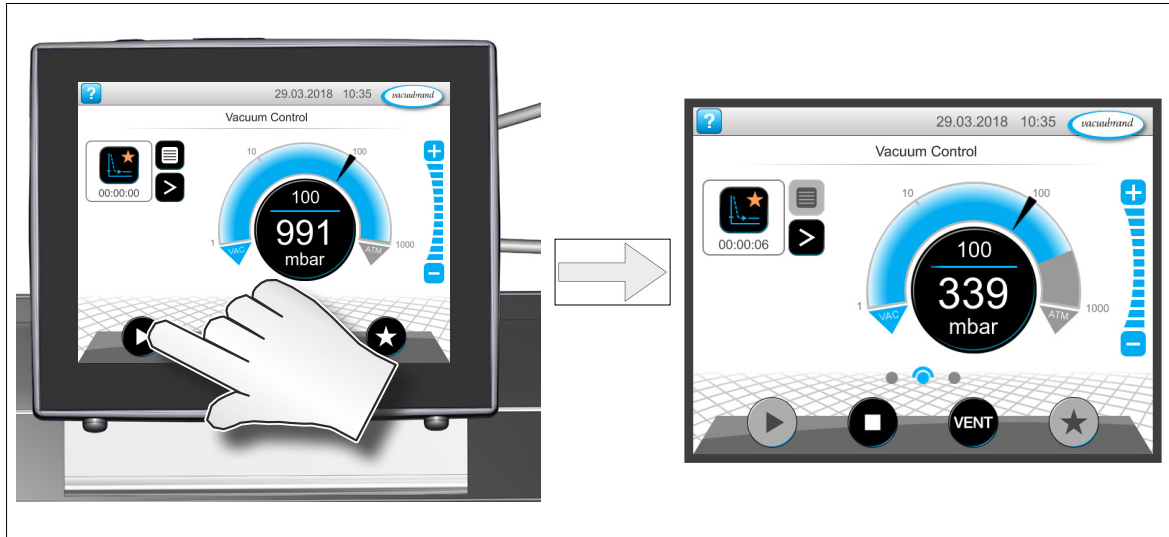

Stop the pump / process:

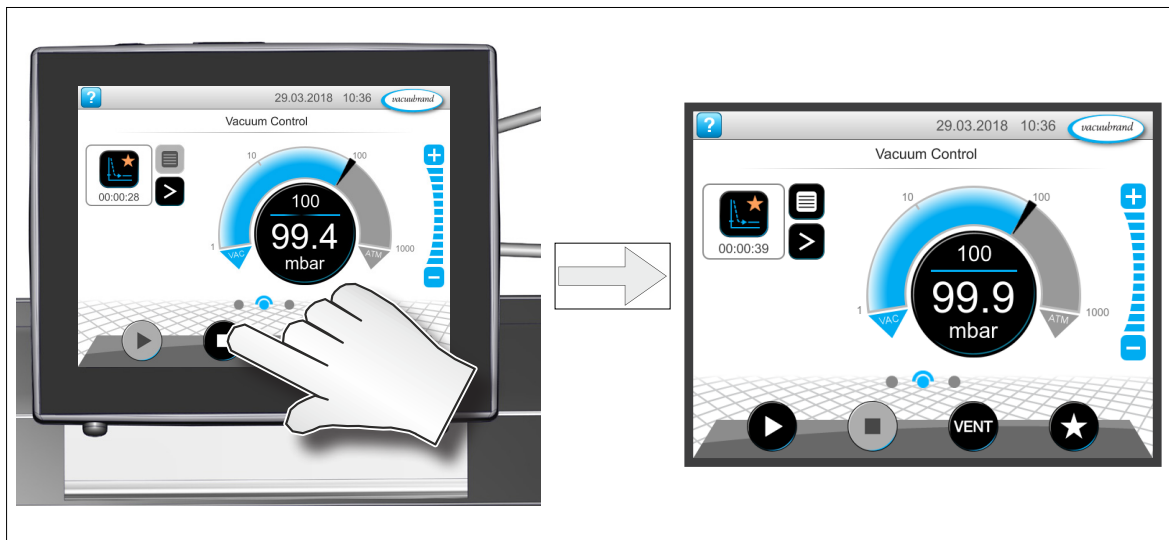

Venting:

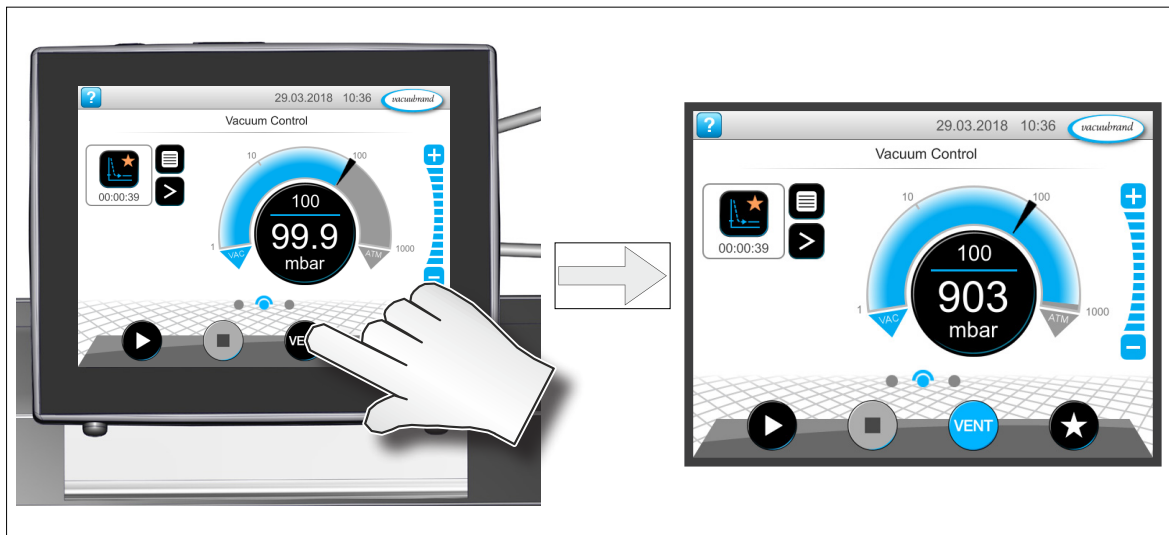

During operation

⚠ DANGER

- ➔ Vent and dispose of **potentially dangerous gases or vapors** at the outlet of the pump appropriately.

⚠ WARNING

- ☞ Due to the high compression ratio, the pump might generate overpressure at the outlet. Check pressure compatibility with system components (e.g., exhaust tubing or exhaust valve) at the outlet. Ensure that the pump outlet is neither blocked nor restricted.

- ☞ **Maximum ambient temperature:** 104 °F (40 °C)
Check the maximum temperatures, if installing the pump in a cabinet or a housing. Make sure ventilation is adequate, especially if the ambient temperature is elevated.

- ☞ Operation with silencer at the outlet: Operating the pump at a high inlet pressure or pumping dusty gases for a long time may cause clogging of the silencer. Check the silencer regularly and replace if necessary, or install a hose nozzle (order no. 20639758) with sealing ring (order no. 20639729) instead.

⚠ CAUTION

- If the pump is installed at an altitude of more than 6500 ft (2000 m) above mean sea level, check compatibility with applicable safety requirements, and adopt suitable measures. There is a risk of the motor overheating due to insufficient cooling.
- Check compatibility with the **maximally permitted pressure** at outlet and the **maximum pressure difference** between inlet and outlet ports.

NOTICE

Do not start the pump if the **pressure difference between inlet and outlet ports exceeds max. 16.0 psi (1.1 bar)**. Attempts to start the pump at higher pressure difference may cause stalling and damage of the motor.

Prevent internal condensation, transfer of liquids or dust. The diaphragms and valves will be damaged, if liquids are pumped in significant amounts.

Check the pump regularly for external soiling and deposits. Clean the pump if necessary to avoid an increase of the pump's operating temperature.

In case of overload, the motor is shut down by a **self-hold thermal cutout** in the winding.

Note: Only manual reset is possible. Acknowledge the error message at the controller. Switch off the pump and disconnect from the power source. Identify and eliminate the cause of failure. Wait approx. five minutes before re-starting the pump.

Check fan regularly for dust/dirt. Clean if necessary. Avoid overheating (e.g., due to hot process gases).

A warm up period (approximately 15 min.) is required to ensure that the rated ultimate vacuum and pumping speed are attained.

Shutdown & storage

The pump can be switched off under vacuum.

NOTICE

Short-term:

Has the pump been exposed to condensate?

- Allow the pump to continue to run at atmospheric pressure for a few minutes.

Has the pump been exposed to media which may damage the pump materials or form **deposits**?

- Check and clean pump heads if necessary.

Has the pressure transducer been exposed to media which may form deposits?

- Clean pressure transducer if necessary.

Long-term:

- Take measures as described above regarding short-term shutdown.
- Separate the pump from the application.
- Close inlet and outlet ports (e.g., with transport caps).
- Store the pump under dry conditions.

Readjustment of vacuum sensor

NOTICE

The device was adjusted using factory standards, which are traceable through regular calibration in an accredited laboratory (DAkkS calibration laboratory) to the German national pressure standard. Depending on the process and/or accuracy requirements, check the adjustment and readjust if necessary. For readjustment, the device has to be adjusted both at atmospheric pressure as well as under vacuum but only if the reference pressures are known with certainty. In the range between 15 to 525 Torr (20 to 700 mbar) no adjustment is possible.

Adjustment at atmospheric pressure

An adjustment at atmospheric pressure is only possible if the pressure is higher than 525 Torr (700 mbar).

Vent the measurement connection of the vacuum sensor (e.g., VACUU•SELECT Sensor) and/or the vacuum system. Make sure that the measurement connection of the vacuum sensor is at atmospheric pressure.

***Note:** To determine the actual atmospheric pressure, use an accurate barometer or get accurate reading from the weather service, or a nearby airport or other reliable source (taking into account the difference in altitude between the source and the laboratory).*

Adjustment under vacuum or at a reference pressure

An adjustment under vacuum is only possible if the pressure is lower than 15 Torr (20 mbar) absolute.

Evacuate the measurement connection of the vacuum sensor to a pressure < 0.1 Torr (mbar) (e.g., by applying a good two-stage rotary vane pump).

Note: Adjustment under vacuum with an actual pressure higher than 0.1 Torr (mbar) reduces the accuracy of the measurement. If the pressure is significantly higher than 0.1 Torr (mbar), adjustment to a reference pressure is recommended.

Instead of adjustment under vacuum to a pressure < 0.1 Torr (mbar), adjustment to a precisely known reference pressure within the range of 0..... 15 Torr (20 mbar) is possible. Evacuate the measurement connection of the vacuum sensor to a pressure within 0 15 Torr (0.....20 mbar).

Note: The accuracy of the value of the reference pressure will directly affect the accuracy of the adjustment. If the nominal ultimate vacuum of a diaphragm pump is used as reference vacuum, the accuracy of the vacuum sensor might be doubtful. The diaphragm pump may not achieve the specified value (due to condensate, poor condition, failure of valves or diaphragm, leaks).

Performing the adjustment

(➡ see manual of VACUU-SELECT vacuum controller)

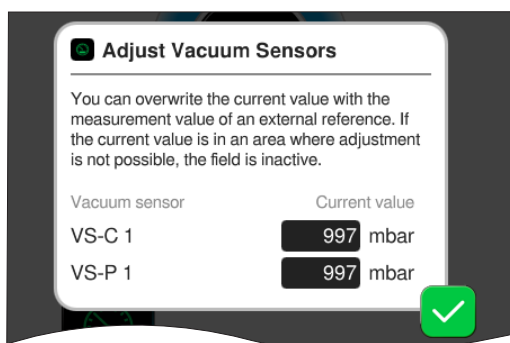

Pop-up for the adjustment of connected vacuum sensors at ambient pressure and under vacuum.

Calibration in the factory

Control of measuring equipment

The **VACUUBRAND DAkkS calibration laboratory** is accredited by the Deutsche Akkreditierungsstelle GmbH (national accreditation body of the Federal Republic of Germany) for the measurable variable **pressure in the pressure range from $7.5 \cdot 10^{-4}$ Torr to 975 Torr (10^{-3} mbar to 1300 mbar)** in accordance with the general criteria for the operation of testing laboratories defined in the DIN EN ISO/IEC 17025 series of standards (accreditation number D-K-15154-01).

The DAkkS is signatory to the multilateral agreements of the European cooperation for Accreditation (EA) and of the International Laboratory Accreditation Cooperation (ILAC) for the mutual recognition of calibration certificates.

Rely on calibration in the VACUUBRAND calibration laboratory:

- To meet the requirements of the DIN ISO 9000ff and 10012 series of standards regarding the calibration of inspection, measuring and test equipment at specified intervals.
- To document that the vacuum gauges calibrated are traceable to national standards of the PTB (Physikalisch-Technische Bundesanstalt; German national institute for science and technology and the highest technical authority of the Federal Republic of Germany for the field of metrology and certain sectors of safety engineering).

To order DAkkS calibration of the VACUU•SELECT Sensor,

order number:**20900215**

Cleaning the pressure transducer

- ➔ **Attention: Never use a pointed or sharp-edged tool to clean the pressure transducer.**
- ➔ **Never touch the ceramic diaphragm of the pressure transducer with hard objects.**
- ➔ Fill the measurement chamber with a solvent (e.g., benzene) and allow sufficient cleaning time. Observe all regulations concerning usage and disposal of solvents!
- ➔ Drain the solvent and dispose of in accordance with regulations. Repeat cleaning if necessary.
- ➔ Rinse the measurement chamber several times with alcohol in order to remove all solvent residues.
- ➔ Allow the pressure transducer to dry.
- ➔ Readjust the pressure transducer if necessary.

Readjustment of the pressure transducer

See section "Readjustment of vacuum sensor", pg. 45.

Accessories

VACUU·SELECT® Sensor without venting valve, 1080-0.1 mbar	20700021
Vacuum gauge VACUU·VIEW, 1100-0.1 mbar	20635490
(without power supply unit)	
Coolant valve VKW-B, 24 V=	20674220
Venting valve VBM-B / KF 16 or hose nozzle 10/6 mm, 24 V=	20674217
Adapter KF DN 16 to hose nozzle 1/2"	20636004
Y-type adapter VACUU·BUS	20636656
Extension cable VACUU·BUS, 0.5 m	20612875
Extension cable VACUU·BUS, 2 m	20612552
Extension cable VACUU·BUS, 20 m	22618493
Wall bushing VACUU·BUS	20636153

Vacuum distribution:

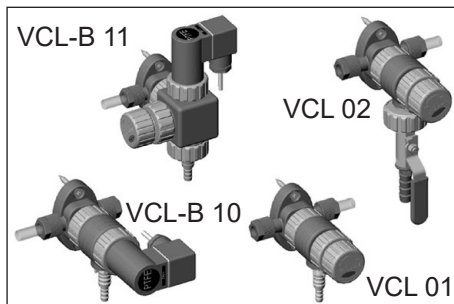

The VACUU·LAN® modules allow process-oriented, flexible and cost effective connections according to your requirements. One vacuum pump can support several workstations. Contact VACUUBRAND for details.

VACUU·LAN® manual flow control module VCL 01	20677106
VACUU·LAN® shut off / manual flow control module VCL 02	20677107
VACUU·LAN® automatic control module VCL-B 10	20677208
VACUU·LAN® manual flow control/ automatic control module VCL-B 11	20677209

On this page we offer only a small selection of VACUU·LAN® options. Please contact VACUUBRAND for further information. Listed modules are designed for surface-mounted installation. Different catalog numbers are used for modules designed for flush-mounting with concealed tubing.

For additional accessories such as vacuum valves, small-flange components, vacuum gauges or vacuum controllers refer to www.vacuubrand.com.

Troubleshooting

➔ See also section „ Error - Cause - Remedy“ in the manual of the VACUU·SELECT vacuum controller

Fault	Possible cause	Remedy
<input type="checkbox"/> Readings deviate from the reference standard.	<ul style="list-style-type: none"> ➔ Vacuum sensor dirty. ➔ Moisture in the sensor. ➔ Sensor defective. ➔ Sensor measures incorrectly. Sensor not correctly adjusted. 	<ul style="list-style-type: none"> ✓ Clean sensor measuring chamber. ✓ Allow sensor measuring chamber to dry, e. g., by pumping. ✓ Contact local distributor. ✓ Adjust sensor with reference gauge.
<input type="checkbox"/> Sensor does not pass on measured value.	<ul style="list-style-type: none"> ➔ VACUU·BUS plug-in connection or cables defective or not connected. ➔ Sensor defective. 	<ul style="list-style-type: none"> ✓ Check VACUU·BUS plug-in connection and cables to the controller. ✓ Contact local distributor.
<input type="checkbox"/> Venting valve does not operate.	<ul style="list-style-type: none"> ➔ VACUU·BUS plug-in connection or cables defective or not connected. ➔ Venting valve dirty. 	<ul style="list-style-type: none"> ✓ Check VACUU·BUS plug-in connection and cables to the controller. ✓ Clean venting valve or use another valve.
<input type="checkbox"/> Vacuum pump does not start.	<ul style="list-style-type: none"> ➔ Overpressure in the outlet line. ➔ Condensation in the vacuum pump. ➔ Pump switched off. ➔ Power plug not correctly plugged in or pulled out. ➔ VACUU·BUS plug-in connection or cables defective or not connected. 	<ul style="list-style-type: none"> ✓ Open the outlet line. Ensure clear passage. ✓ Allow pump to run for some minutes with atmospheric pressure at the inlet to purge. ✓ Switch pump on using rocker switch. ✓ Check power supply and cable. ✓ Check VACUU·BUS plug-in connection and cables to the controller.

Fault	Possible cause	Remedy
<input type="checkbox"/> Vacuum pump does not start.	<ul style="list-style-type: none"> ➔ Motor overloaded. Thermal protection has been triggered. 	<ul style="list-style-type: none"> ✓ Allow the motor to cool down. Clear error manually: Unplug pump from the power supply - Eliminate cause of error - Switch pump back on.
<input type="checkbox"/> No or very little suction power.	<ul style="list-style-type: none"> ➔ Leak in the suction line or apparatus. ➔ Centring ring at small flange connection not correctly positioned. ➔ Vacuum line too long or cross-section too small. ➔ Condensation in the vacuum pump. ➔ Deposits inside the vacuum pump. ➔ Diaphragms or valves defective. ➔ High level of vapor generated in the process. ➔ Pump too hot. 	<ul style="list-style-type: none"> ✓ Check suction line and apparatus for leaks. ✓ Check small flange connection at pump inlet. ✓ Use a shorter vacuum line with a larger cross-section. ✓ Allow pump to run for some minutes with atmospheric pressure at the inlet to purge. ✓ Clean and check pump heads. ✓ Replace diaphragms and valves. ✓ Check process parameters and settings at controller. ✓ Allow pump to cool down. Determine and eliminate the cause of overheating.
<input type="checkbox"/> No display.	<ul style="list-style-type: none"> ➔ Pump switched off. ➔ Power plug not correctly plugged in or pulled out. ➔ VACUU·BUS plug-in connection or cables defective or not connected. ➔ Controller switched off. ➔ Controller defective. 	<ul style="list-style-type: none"> ✓ Switch pump on using rocker switch. ✓ Check power supply and cable. ✓ Check VACUU·BUS plug-in connection and cables to the controller. ✓ Switch on controller. ✓ Contact local distributor.

Fault	Possible cause	Remedy
<input type="checkbox"/> Loud operating noises.	<ul style="list-style-type: none"> ➔ Loud outlet noise, outlet line open. ➔ Diaphragm crack or diaphragm clamping disc loose? ➔ Ball bearing defective. or other than above mentioned causes? 	<ul style="list-style-type: none"> ✓ Check connections at outlet. Connect hose or silencer to pump outlet. Be careful not to cause outlet overpressure, especially with condensable vapors. ✓ Perform maintenance and replace defective parts. ✓ Contact local distributor.
<input type="checkbox"/> Pump stops and does not start again.	<ul style="list-style-type: none"> ➔ The preset motor speed is too low for the motor type and the application configuration? ➔ The setting of the motor speed at the controller is too low, e. g., "Pump Down" with a motor speed of 5 %? ➔ The control operates the motor with a too low speed? 	<ul style="list-style-type: none"> ✓ Set a motor speed > 15 % at the controller.
<input type="checkbox"/> Pump seized.		<ul style="list-style-type: none"> ✓ Contact local distributor.

➔ A service manual with exploded view drawings, spare parts list and directions for repair is available on request.

👉 The service manual is intended for trained service people only.

Replacing diaphragms and valves

☞ Please read section "Replacing diaphragms and valves" completely before starting maintenance.

The pictures may show other versions of pumps. This does not change the method of replacing diaphragms and valves.

DANGER

➔ Never operate the pump if covers or other parts of the pump are disassembled.



➔ Before starting maintenance, **disconnect the electrical power cord. Wait two minutes** after isolating the equipment from AC power to allow the capacitors to discharge.

➔ Ensure that the pump cannot be operated accidentally.

➔ **Note:** The pump might be contaminated with the process chemicals that have been pumped during operation. Ensure that the pump is decontaminated before maintenance.

➔ Avoid the release of pollutants.

WARNING

☞ Never operate a defective or damaged pump.

☞ Take adequate precautions to protect people from the effects of dangerous substances that may have contaminated the pump and may be released upon disassembly. Ensure that the maintenance technician is familiar with the safety procedures which relate to the products processed by the pumping system.

Use appropriate protective clothing, safety goggles and protective gloves.

☞ Allow sufficient cooling of the pump before starting maintenance.

☞ **Vent the pump and isolate it from the vacuum system before you start maintenance.**

NOTICE

Ensure that maintenance is done only by suitably trained and supervised technicians.

The valves and diaphragms are wear parts. If the rated ultimate vacuum is no longer achieved or in case of increased noise level, the pump interior, the diaphragms and the valves must be cleaned and the diaphragms and valves must be checked for cracks or other damage.

All bearings are encapsulated and are filled with long-life lubricant. Under normal operating conditions, the drive system is maintenance free.

In demanding circumstances, it may be efficient to check and clean the pump heads on a regular basis. In normal use, the lifetime of the diaphragms and valves is typically 15,000 operating hours.

- Prevent internal condensation, transfer of liquids or dust. The diaphragms and valves will be damaged if liquid is pumped in significant amount.
- Carry out maintenance frequently if the pump is exposed to corrosive media or in case of deposits.
- Regular maintenance will improve the lifetime of the pump and also protect both users and the environment.

Service kit for MD 4 NT VARIO / MV 2 NT VARIO	20696861
Diaphragm key (width 66 mm)	20636554

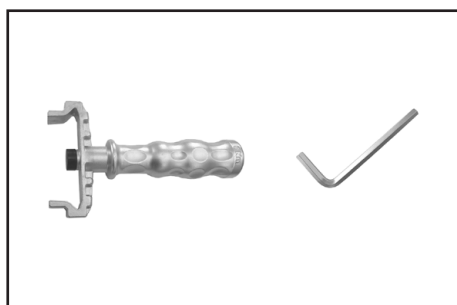
**Tools required (metric):**

- 5 mm wide Allen key
- Diaphragm key width 66 mm

Cleaning and inspecting the pump heads

- ➡ Lay the pump on its side. Support the pump appropriately.
- 👉 Service only one side of the pump at a time to avoid the mixing of parts.

View of the disassembled pump head parts

(fig.: MD 4 VARIO select)

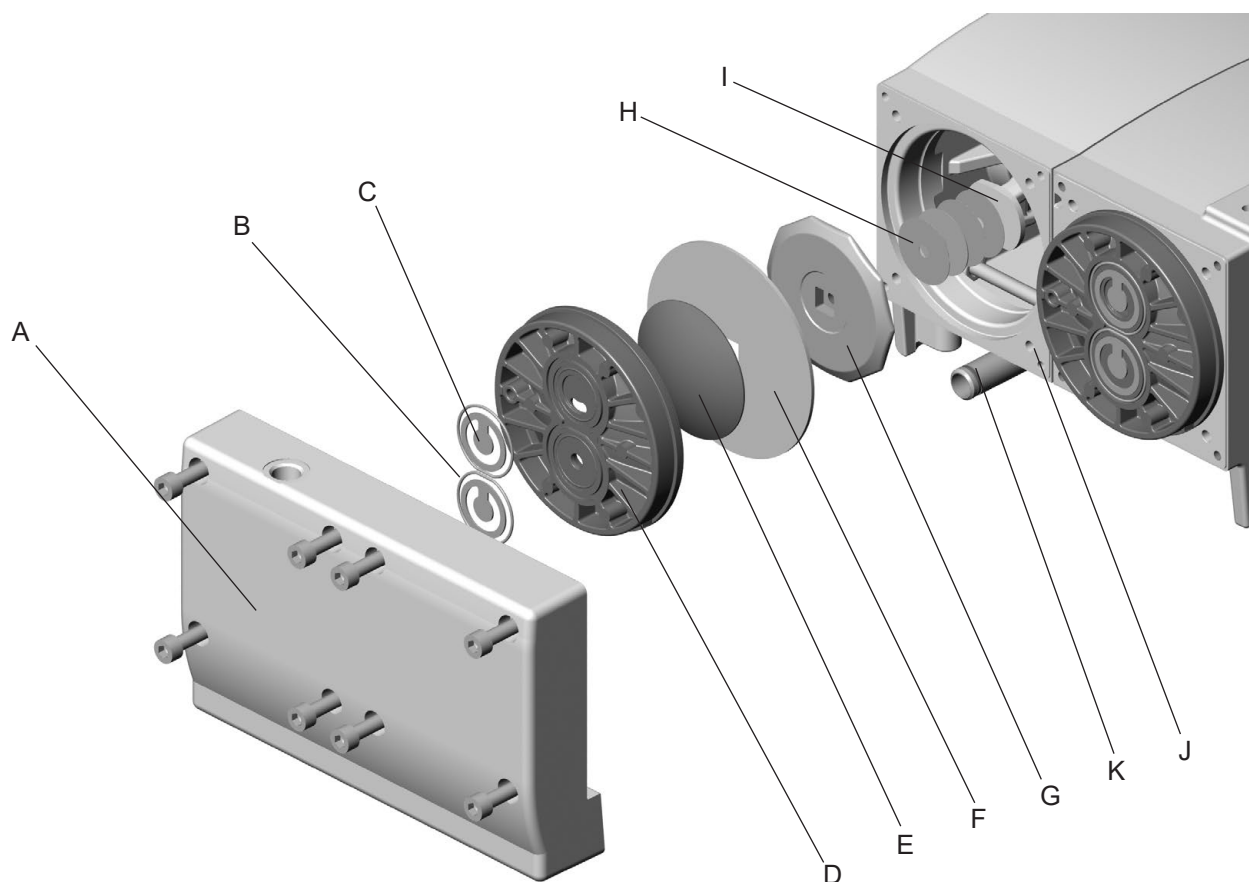

Pump head parts:

- | | |
|--|--------------------------------|
| A: Housing cover | F: Diaphragm |
| B: O-rings | G: Diaphragm support disc |
| C: Valves | H: Washer |
| D: Head cover | I: Connecting rod |
| E: Diaphragm clamping disc
with square head screw | J: Housing |
| | K: Connecting tube with O-ring |

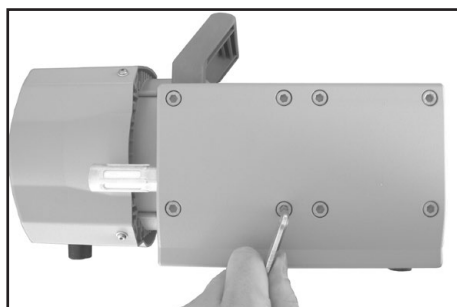

- Disassemble the housing cover (A) to check the valves (C).
- Unscrew eight Allen screws with a 5mm wide Allen key. Remove the housing cover (A) together with head cover (D), valves (C) and O-rings (B).

- ☞ Never use a pointed or sharp-edged tool to remove parts (e.g., screwdriver). We recommend to use a rubber mallet or compressed air (to be blown carefully into port).
- Remove the head cover (D) carefully from the housing cover (A). Note position and alignment of valves (C). Remove the valves.
- ☞ Replace valves or O-rings if necessary.
- ☞ Use petroleum ether or other industrial solvent to remove deposits. Do not inhale vapors.
- ☞ Underneath the pump there is a connecting tube (K) between the two housing covers. The connecting tube is merely stuck into the housing covers and sealed with seal rings at the connecting tube's ends. If the housing cover is removed, the connecting tube becomes detached as well.

Replacing the diaphragm

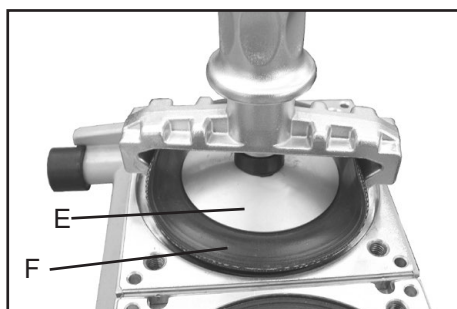

- ☞ Check diaphragm (F) for damage and replace if necessary.
- Lift diaphragm carefully sidewise.
- ☞ Never use a pointed or sharp-edged tool to lift the diaphragm.
- Use the diaphragm key to grip the diaphragm support disc (G) below the diaphragm.
- Unscrew diaphragm support disc (G) with diaphragm (F) and diaphragm clamping disc (E).
- Check for washers (H) between the diaphragm support disc (G) and the connecting rod (I). Do not mix the washers from the different pump heads, since these are set at the factory to ensure proper pump performance. Make sure that the original number is reassembled at the individual pump head.

- ☞ Too few washers: The pump will not attain vacuum specification. Too many washers: Diaphragm clamping disc will hit head cover, causing noisy operation and possibly causing the pump to seize up.
- ☞ If the old diaphragm is difficult to separate from the diaphragm support disc, immerse assembly in naphtha or petroleum ether. Do not inhale vapors!

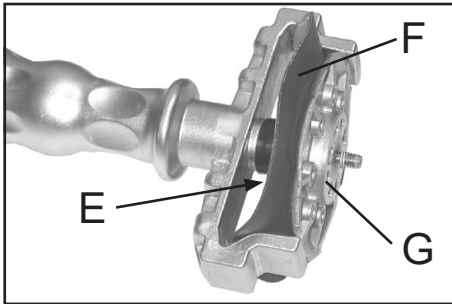

- Position new diaphragm (F) between diaphragm clamping disc with square head screw (E) and diaphragm support disc (G).
- ☞ Note: This is a double diaphragm consisting of two single diaphragms! Put the two diaphragms together with the printed sides outwards.

- ☞ Make sure that the square head screw of the diaphragm clamping disc is correctly seated in the guide hole of the diaphragm support disc.
- Lift the diaphragm at the side. Place the diaphragm carefully together with diaphragm clamping disc and diaphragm support disc in the diaphragm key.
- ☞ Avoid damage of the diaphragm: Do not excessively bend or crease the diaphragm.

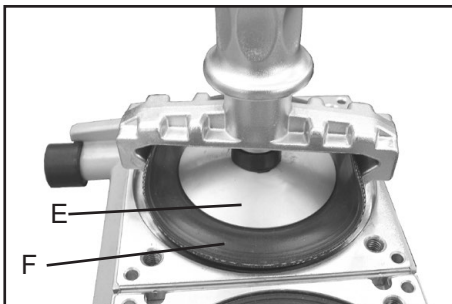

- ☞ Assemble the original number of washers (H) between diaphragm support disc (G) and connecting rod (I).
- Screw diaphragm clamping disc (E), diaphragm (F), diaphragm support disc (G), and washers (H) to connecting rod (I).

- Optimum torque for the diaphragm support disc: 4.4 ft·lb_f (6 Nm), it is recommended to use a torque wrench. Attach torque wrench to diaphragm key (hexagonal bolt 6 mm wide).
Note: Never use the diaphragm key with any additional tools like tongs or Allen keys without appropriate torque limitation.

Assembling the pump heads

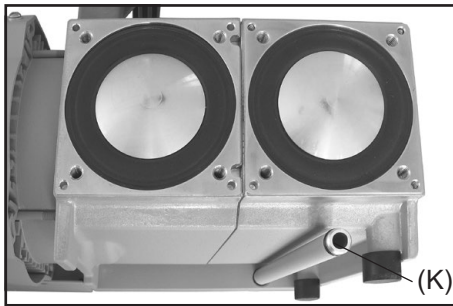

- Bring the diaphragms (F) into a position, in which they are in contact with the housing (J) and centered with respect to the bore.

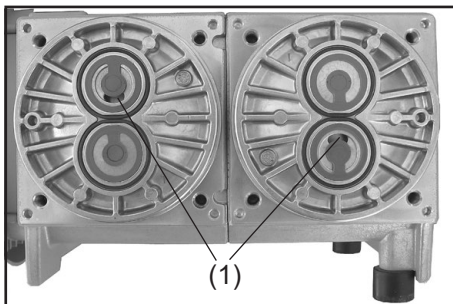

- Put on head covers (D).
- ☞ Pay attention to the correct orientation of the head covers: Align the nib at the head cover (D) with the notch of the housing cover (A).
- ☞ Make sure that the diaphragm stays centered with respect to the bore so that it will become clamped uniformly between housing (J) and head cover (D).
- Put the valves (C) and O-rings (B) in place. See figure for the correct position of the valves:
 - Inlet side** of pump head: The valve tongue points at the kidney-shaped orifice in the valve seat (1).
 - Outlet side** of pump head: The valve is oriented the same direction as the valve at the inlet side.
- Put on housing cover (A).
- ☞ If it is not possible to position the housing cover, check the head covers for correct orientation. The nib at the head cover has to lock into the notch of the housing cover.
- Install the connecting tube (K) under the pump between the two housing covers. Pay attention to the correct positions of the seal rings (replace if damaged) in the grooves at the ends of the tube. Fit the connecting tube in the bore of the housing cover. After assembly the connecting tube may have some play.

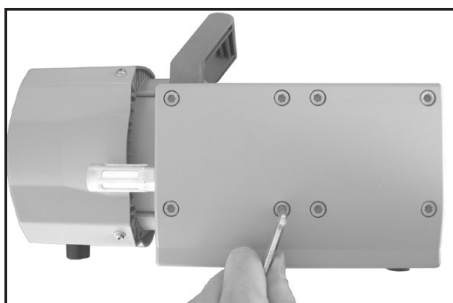

- Screw in the Allen head screws at the head covers diagonally at first slightly with a 5 mm wide Allen key, then tighten.
- ☞ Recommended torque: 8.9 ft·lb_f (12 Nm).

Replace diaphragms and valves of the opposite side of the pump in the same way!

Checking the ultimate vacuum

- After any intervention at the equipment (e.g., repair / maintenance) the ultimate vacuum of the pump has to be checked. Only if the pump achieves its specified ultimate vacuum, the pump's leak rate is low enough to ensure that no explosive atmospheres will occur in the interior of the equipment.

After any intervention at the vacuum sensor the leak rate of the equipment has to be checked.

If the pump does not achieve the ultimate vacuum:

- Whenever the diaphragms and valves have been replaced, a break-in period of several hours is required before the pump achieves its ultimate vacuum.
- In case of an unusual noise, switch off pump immediately and check clamping disc positions.

If the specified ultimate vacuum is not achieved, and if this does not change after the break-in period:

If necessary recheck valve seats and pump chambers.

Replacing the device fuse

⚠ DANGER ➔ **Switch off the pump.**



- ➔ **Disconnect the electrical power cord** before unscrewing the fuse holder. Identify and eliminate the cause of failure before switching on the pump again.

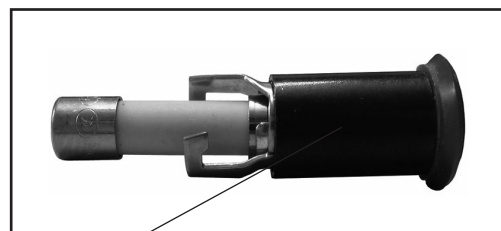
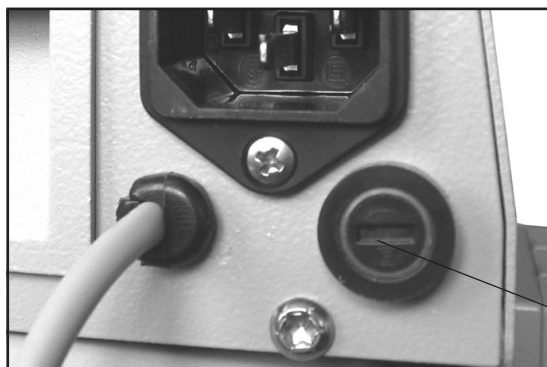

fuse holder

- ➔ Unscrew the fuse holder using a slotted screw driver.
- ➔ Replace the defective fuse by a fuse of the same type (see “Technical data”, pg. 26). Reassemble holder with fuse to the pump.

Repair - Maintenance - Return - Calibration

IMPORTANT

Every employer (user) is held responsible for the health and safety of his employees. This also applies to service personnel performing repair, maintenance, return or calibration.

The **health and safety clearance form** informs the contractor about any possible contamination of the device and forms the basis for the risk assessment.

In case of devices which have been in contact with biological substances of risk level 2 contact the VACUUBRAND service absolutely before dispatching the device. These devices have to be completely disassembled and decontaminated by the user prior to shipment. Do not return devices which have been in contact biological substances of risk level 3 or 4. These devices cannot be checked, maintained or repaired. Also decontaminated devices must not returned to VACUUBRAND due to a residual risk.

The same conditions apply to on-site work.

No repair, maintenance, return or calibration is possible unless the correctly completed health and safety clearance form is returned. Devices sent are rejected if applicable. Send a completed copy of the **health and safety clearance form** to us in advance. The declaration must arrive before the equipment. Enclose a second completed copy with the product.

Remove all components from the device that are no original VACUUBRAND components. VACUUBRAND will not be responsible for lost or damaged components that are no original components.

Drain the device completely of fluids and residues. Decontaminate the device. Close all openings airtight especially if using substances hazardous to health.

To expedite repair and to reduce costs, please enclose a detailed description of the problem and the product's operating conditions with every product returned.

If you do not wish a repair on the basis of our **quotation**, the device may be returned to you disassembled and at your expense.

In many cases, the components must be cleaned in the factory prior to repair.

For cleaning we use an environmentally friendly water based process. Unfortunately the combined attack of elevated temperature, cleaning agent, ultrasonic treatment and mechanical stress (from pressurised water) may result in damage to the paint. Please mark in the health and safety clearance form if you wish a repaint at your expense just in case such a damage should occur. We will also replace parts for cosmetic reasons at your request and at your expense.

Before returning the device

Pack the device properly, if necessary, please order original packaging materials at your costs.

Mark the package completely

Enclose the completed health and safety clearance form.

Notify the carrier of any possible contamination if required.

Scrapping and waste disposal

Dispose of the equipment and any components removed from it safely in accordance with all local and national safety and environmental requirements. Particular care must be taken with components and waste oil which have been contaminated with dangerous substances from your processes. Do not incinerate fluoroelastomer seals and O-rings. You may authorize us to dispose of the equipment **at your expense**. Otherwise we return the device at your expense.

Warranty

VACUUBRAND shall be liable for insuring that this product, including any agreed installation, has been free of defects at the time of the transfer of risk.

VACUUBRAND shall not be liable for the consequences of improper handling, use, servicing or operation of this product or the consequences of normal wear and tear of wearing parts such as diaphragms, seals, valves, vanes, condensers, oil and the breakage of glass or ceramic parts, for the consequences of chemical, electrochemical or electrical influences or the failure to follow the instructions in this manual.

Claims for defects against VACUUBRAND shall be limited to one year from delivery. The same shall apply to claims for damages irrespective of legal grounds.

For further information on general terms and conditions refer to www.vacuubrand.com.

Health and safety clearance form

1. Device (Model):

2. Serial no.:

3. Reason for return / malfunction:

4. Has the device been used in a copper process step (e.g., semiconductor production): yes no

5. Substances (gases, liquids, solids, biological material, e. g. bacteria, viruses) in contact with the device / which have been pumped:

.....
.....
.....

6. Risk level of the used biological material: none 1 2* 3** 4**

* Contact the VACUUBRAND service absolutely before dispatching the device.

** Devices which have been in contact with biological substances of risk level 3 or 4 cannot be checked, maintained or repaired. Also decontaminated devices must not returned to VACUUBRAND due to a residual risk.

7. Radioactive contamination: yes no

8. Prior to return to the factory the device has been decontaminated: yes no

Description of the decontamination method and the test / verification procedure:

.....
.....

9. All parts of the device are free of hazardous, harmful substances: yes no

10. Protective measures required for service staff:

.....

11. If the paint is damaged, we wish a repaint or a replacement of parts for reason of appearance (repaint and replacement at customer's expense): yes no

12. Legally binding declaration

We assure for the returned device that all substances, which have been in contact with the device are listed in section 5 and that the information is complete and that we have not withheld any information. We declare that all measures - where applicable - have been taken listed in section "Repair - Maintenance - Return - Calibration". By our signature below, we acknowledge that we accept liability for any damage caused by providing incomplete or incorrect information and that we shall indemnify VACUUBRAND from any claims as regards damages from third parties. We are aware that as expressed in § 823 BGB (Public Law Code of Germany) we are directly liable for injuries or damages suffered by third parties, particularly VACUUBRAND employees occupied with handling/repairing the product. Shipping of the device must take place according to regulations.

Name: Signature:

Job title: Company's seal:

Date:

Release for repair grant by VACUUBRAND (date / signature):.....
Protective measures: Protective gloves, safety goggles Hood External cleaning



EG-Konformitätserklärung für Maschinen
EC Declaration of Conformity of the Machinery
Déclaration CE de conformité des machines



Hersteller / Manufacturer / Fabricant:

VACUUBRAND GMBH + CO KG · Alfred-Zippe-Str. 4 · 97877 Wertheim · Germany

Hiermit erklärt der Hersteller, dass das Gerät konform ist mit den Bestimmungen der Richtlinien:

Hereby the manufacturer declares that the device is in conformity with the directives:

Par la présente, le fabricant déclare, que le dispositif est conforme aux directives:

- 2006/42/EU
- 2014/30/EU
- 2014/34/EU
- 2011/65/EU, 2015/863

Membranvakuumpumpe / Diaphragm vacuum pump / Pompe à membrane:

Typ / Type / Type: **MD 4 VARIO select / MV 2 VARIO select**

Artikelnummer / Order number / Numéro d'article: 20736350, 20736351 / 20738150, 20738151, 20738156

Seriennummer / Serial number / Numéro de série: Siehe Typenschild / See rating plate / Voir plaque signalétique

Angewandte harmonisierte Normen / Harmonized standards applied / Normes harmonisées utilisées:

DIN EN ISO 12100:2011, DIN EN 61010-1:2020, IEC 61010-1:2010 (Ed. 3), DIN EN 1012-2:2011

DIN EN 61326-1:2013: Klasse / class / classe A + B

DIN EN 1127-1:2019, DIN EN ISO 80079-36:2016

DIN EN IEC 63000:2019

Bevollmächtigter für die Zusammenstellung der technischen Unterlagen / Person authorised to compile the technical file / Personne autorisée à constituer le dossier technique:

Dr. F. Gitmans · VACUUBRAND GMBH + CO KG · Germany

Ort, Datum / place, date / lieu, date: Wertheim, 28.10.2021



 (Dr. F. Gitmans)
 Geschäftsführer / Managing Director /
 Gérant



 ppa.
 (J. Kaibel)
 Technischer Leiter / Technical Director /
 Directeur technique

VACUUBRAND GMBH + CO KG

Alfred-Zippe-Str. 4
 97877 Wertheim

Tel.: +49 9342 808-0

Fax: +49 9342 808-5555

E-Mail: info@vacuubrand.com

Web: www.vacuubrand.com

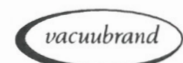

Declaration of Conformity



Manufacturer:

VACUUBRAND GMBH + CO KG · Alfred-Zippe-Str. 4 · 97877 Wertheim · Germany

Hereby the manufacturer declares that the device is in conformity with the directives:

- Supply of Machinery (Safety) Regulations 2008 (S.I. 2008 No. 1597, as amended by S.I. 2019 No. 696)
- Electromagnetic Compatibility Regulations 2016 (S.I. 2016 No. 1091, as amended by S.I. 2019 No. 696)
- The Equipment and Protective Systems Intended for Use in Potentially Explosive Atmospheres Regulations 2016 (S.I. 2016 No. 1107, as amended by S.I. 2019 No. 696)
- The Restriction of the Use of Certain Hazardous Substances in Electrical and Electronic Equipment Regulations 2012 (S.I. 2012 No. 3032)

Diaphragm vacuum pump:

Type: **MD 4 VARIO select / MV 2 VARIO select**

Order number: 20736350, 20736351 / 20738150, 20738151, 20738156

Serial number: See rating plate

Harmonized standards applied:

EN ISO 12100:2010, EN 61010-1:2010+A1:2019, EN 1012-2:2010

EN 61326-1:2013: class A + B

EN 1127-1:2019, EN ISO 80079-36:2016

EN IEC 63000:2018

Person authorised to compile the technical file:

Dr. F. Gitmans · VACUUBRAND GMBH + CO KG · Germany

Place, date: Wertheim, 28.10.2021



 (Dr. F. Gitmans)
 Managing Director

ppa. 

 (J. Kaibel)
 Technical Director

VACUUBRAND GMBH + CO KG

Alfred-Zippe-Str. 4
97877 Wertheim

Tel.: +49 9342 808-0

Fax: +49 9342 808-5555

E-Mail: info@vacuubrand.com

Web: www.vacuubrand.com

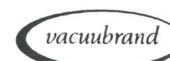



DECLARATION OF CONFORMITY – China RoHS 2

VACUUBRAND GMBH + CO KG has made reasonable efforts to ensure that hazardous materials and substances may not be used in its products.

In order to determine the concentration of hazardous substances in all homogeneous materials of the subassemblies, a “Product Conformity Assessment” (PCA) procedure was performed. As defined in GB/T 26572 the “Maximum Concentration Value” limits (MCV) apply to these restricted substances:

- Lead (Pb): 0.1%
- Mercury (Hg): 0.1%
- Cadmium (Cd): 0.01%
- Hexavalent chromium (Cr(+VI)): 0.1%
- Polybrominated biphenyls (PBB): 0.1%
- Polybrominated diphenyl ether (PBDE): 0.1%

Environmentally Friendly Use Period (EFUP)



EFUP defines the period in years during which the hazardous substances contained in electrical and electronic products will not leak or mutate under normal operating conditions. During normal use by the user such electrical and electronic products will not result in serious environmental pollution, cause serious bodily injury or damage to the user’s assets.

The Environmentally Friendly Use Period for VACUUBRAND products is 40 years.



此表格是按照SJ/T 11364-2014中规定所制定的。

This table is created according to SJ/T 11364-2014.

MATERIAL CONTENT DECLARATION FOR VACUUBRAND PRODUCTS							
部件名称 Part name	有毒有害物质或元素 Hazardous substances						环保期限标识 EFUP
	铅 Pb	汞 Hg	镉 Cd	六价铬 Cr(+VI)	多溴联苯 PBB	多溴二苯醚 PBDE	
包装 Packaging	○	○	○	○	○	○	
塑料外壳 / 组件 Plastic housing / parts	○	○	○	○	○	○	
真空油 Vacuum oil	○	○	○	○	○	○	
电池 Battery	○	○	○	○	○	○	
玻璃 Glass	X	○	○	○	○	○	
电子电气组件 Electrical and electronic parts	X	○	○	○	○	○	
控制器 / 测量设备 Controller / measuring device	X	○	○	○	○	○	
金属外壳 / 组件 Metal housing / parts	X	○	○	○	○	○	
电机 Motor	X	○	○	○	○	○	
配件 Accessories	X	○	○	○	○	○	



注释: 此表格适用于所有产品。以上列出的元件或组件不一定都属于所附产品的组成。

Note: Table applies to all products. Some of the components or parts listed above may not be part of the enclosed product.

- O: 表示该有毒有害物质在该部件所有均质材料中的含量均在GB/T 26572规定的限量要求以下。
 O: Indicates that the above mentioned hazardous substance contained in all homogeneous materials of the part is below the required limit as defined in GB/T 26572.
- X: 表示该有毒有害物质至少在该部件某一均质材料中的含量超出GB/T 26572规定的限量要求。
 X: Indicates that the above mentioned hazardous substance contained in at least one of the homogeneous materials of this part is above the required limit as defined in GB/T 26572.

除上表所示信息外，还需声明的是，这些部件并非是有意图用铅（Pb）、汞（Hg）、铬（Cd）、六价铬（Cr(+VI)）、多溴联苯（PBB）或多溴二苯醚（PBDE）来制造的。

Apart from the disclosures in the above table, the subassemblies are not intentionally manufactured or formulated with lead (Pb), mercury (Hg), cadmium (Cd), hexavalent chromium (Cr+VI), polybrominated biphenyls (PBB), and polybrominated diphenyl ethers (PBDE).

Products manufactured by VACUUBRAND may enter into further devices (e.g., rotary evaporator) or can be used together with other appliances (e.g., usage as booster pumps).

With these products and appliances in particular, please note the EFUP labeled on these products. VACUUBRAND will not take responsibility for the EFUP of those products and appliances.

Place, date: Wertheim, 06/04/2020

(Dr. F. Gitmans)
Managing Director

i.A. (Dr. A. Wollschläger)
Regulatory Affairs Manager

VACUUBRAND GMBH + CO KG
Alfred-Zippe-Str. 4
97877 Wertheim
Germany

Tel.: +49 9342 808-0
Fax: +49 9342 808-5555
E-Mail: info@vacuubrand.com
Web: www.vacuubrand.com

Disclaimer: Our technical literature is only intended to inform our customer. The applicability of general empirical values and results obtained under lab conditions to your specific operations depends on a number of factors beyond our control. It is, therefore, strictly the users' responsibility to very carefully check the application of these data to their specific requirements. No claims arising from the information provided in this literature will, consequently, be entertained.



Alfred-Zippe-Str. 4 · 97877 Wertheim / Germany
T +49 9342 808-0 · F +49 9342 808-5555
info@vacuubrand.com · www.vacuubrand.com

VACUUBRAND GMBH + CO KG
- Technology for Vacuum Systems -
© 2022 VACUUBRAND GMBH + CO KG Printed in Germany