

Chemistry diaphragm pump ME 2C NT

[Link to the website](#)



Product description

One-stage diaphragm pumps are an excellent solution for continuous, oil-free pumping of gases and vapors at low vacuum requirement. In contrast to waterjet pumps they do not consume water and therefore do not produce any contaminated waste water in daily use. Typical applications are vacuum ovens, filtrations and multi-port manifolds for medium throughput, as well as pumping of gases and oil-free evacuation in general. The one-stage construction provides the advantageous combination of high pumping speed and low ultimate vacuum down to 70 mbar.

Performance features

- whisper quiet and very low vibration
- powerful, even for parallel operation of several applications
- high performance even at low vacuum levels
- outstanding chemical resistance
- long diaphragm life, maintenance-free drive system

Ordering data

Product name	Nominal mains voltage mains frequency	Plug type	Articleno.
ME 2C NT	230 V 50-60 Hz	CEE	20730100
ME 2C NT	230 V 50-60 Hz	UK, IN	20730102
ME 2C NT	100-115 V 50-60 Hz 120 V 60 Hz	US	20730103

Items supplied

Pump completely mounted, ready for use, with manual.

Accessories

- Silencer with hose 5cm DN 8-10mm (20636588)
- Rubber vacuum tubing DN 8 mm (20686001)

Technical data

Max. pumping speed 50 Hz (mbar)	2.1 m ³ /h
Max. pumping speed 60 Hz (cfm)	1.4 cfm
Ultimate vacuum	70 mbar / 52 torr
Number of heads	1
Number of stages	1
Permissible ambient temperature range (operation)	10 - 40 °C
Permissible ambient temperature range (storage)	-10 - 60 °C
Max. outlet pressure (abs.)	1.1 bar
Inlet connection	Hose nozzle DN 8-10 mm
Outlet connection	Hose nozzle DN 8-10 mm
Rated motor power	0.18 kW
Rated speed 50/60 Hz	1500/1800 min ⁻¹
Protection class IEC 60529	IP 40
Dimensions (L x W x H)	243 mm x 211 mm x 198 mm
Weight	10.2 kg
Noise (sound pressure level) in dBA at 50 Hz or 1500 rpm/62% (VARIO)/1500 rpm (VARIO-SP)/12500 Upm (VACUU·PURE®)	45 dBA
NRTL certification	Yes

Pumping speed graph at 50 Hz

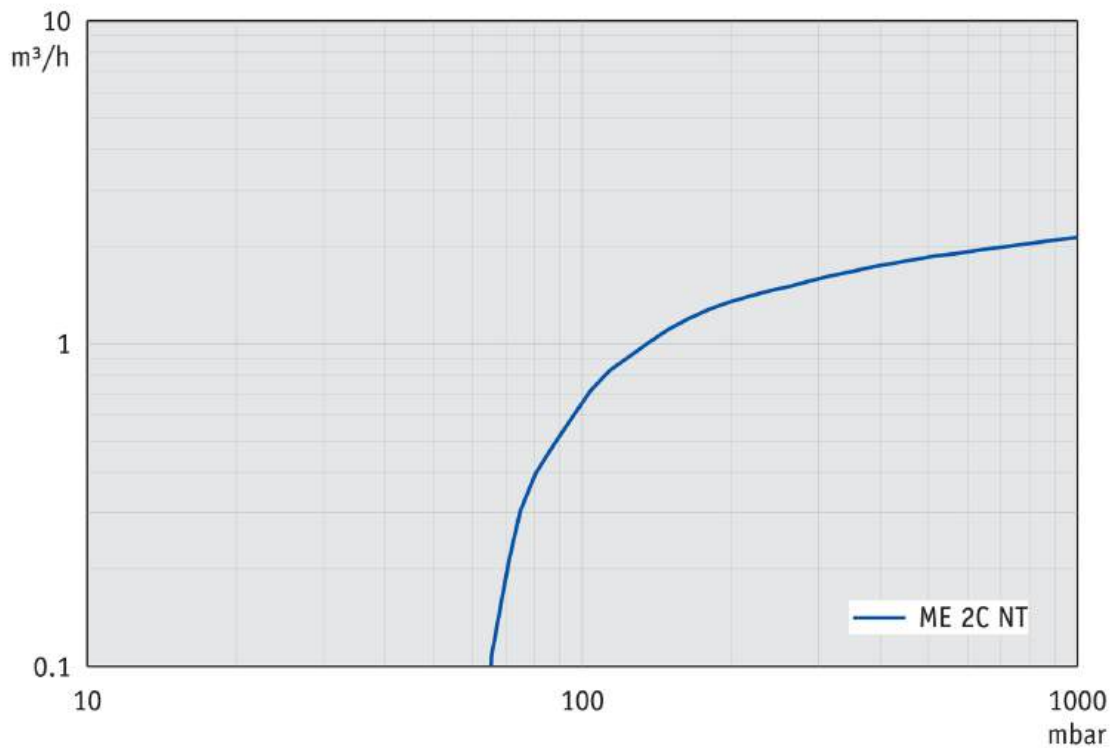

Pump down graph at 50 Hz (10 l volume)

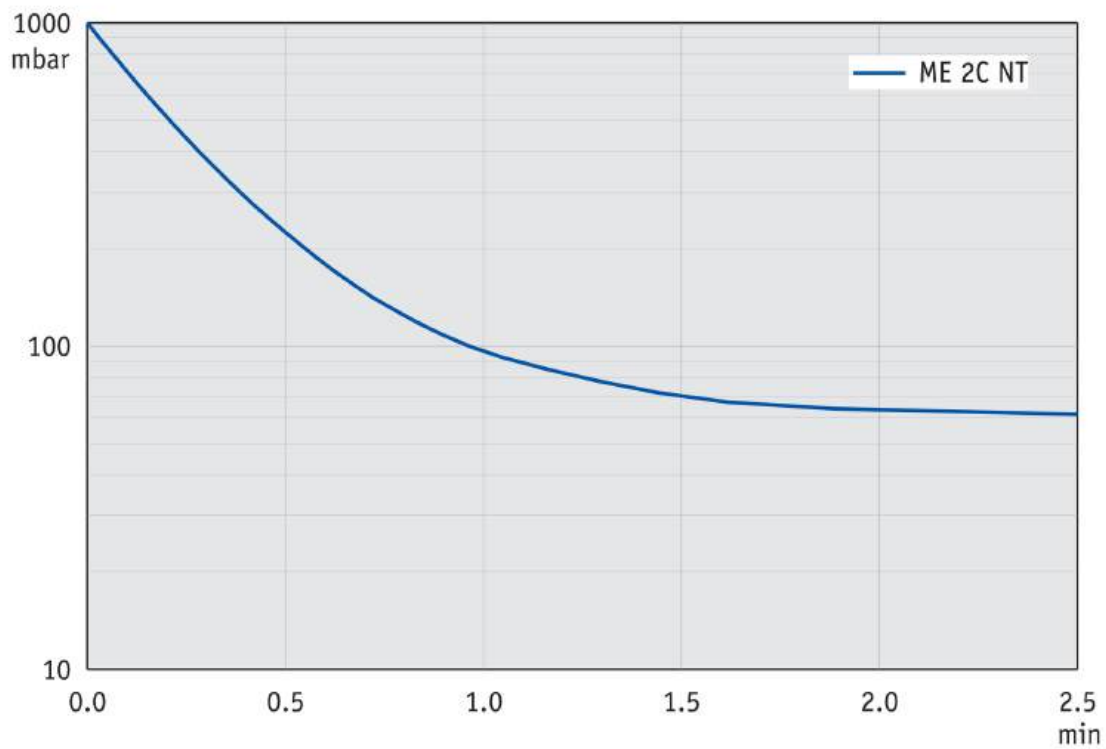

Pumping speed graph at 60 Hz

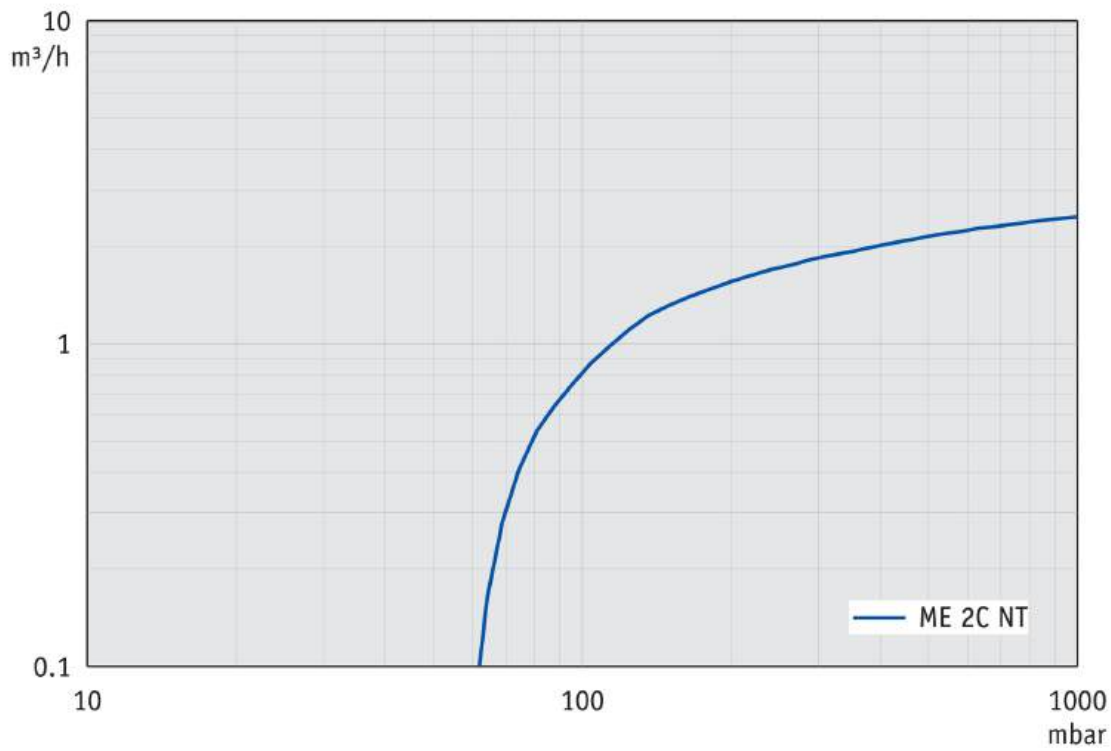

Pump down graph at 60 Hz (10 l volume)

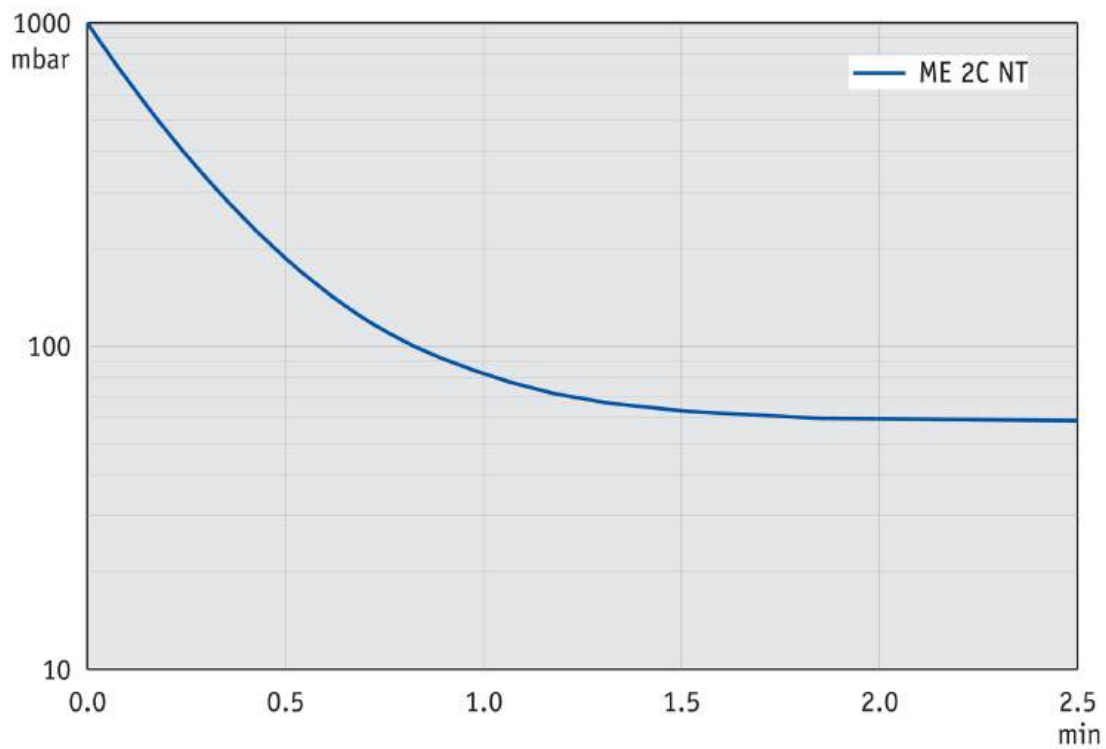

Dimension sheet

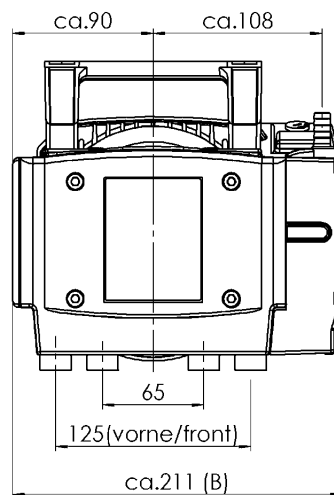
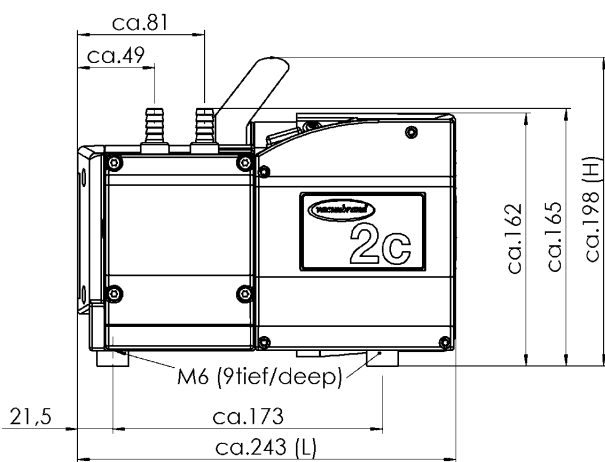

EX - Schlauchwelle 10
hose nozzle 10

IN - Schlauchwelle 10
hose nozzle 10

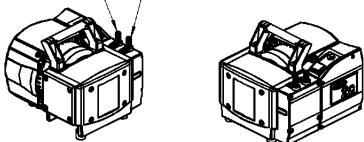

Alle Maße / all dimensions (mm)

VACUUBRAND ME 2C NT 100-230V
Version 2011/11/28

VACUUBRAND GMBH + CO KG
P.O. Box 1664
97877 Wertheim
T +49 9342 808 5550
F +49 9342 808 5555

info@vacuubrand.com
www.vacuubrand.com

VACUUBRAND®

VACUUBRAND is part of the Brand group, a manufacturer of high-quality and innovative laboratory equipment and vacuum technology with a global team of approx. 1,000 employees.

With highly motivated and qualified employees, we manufacture the world's most comprehensive product family for vacuum generation, measurement and control for the rough and fine vacuum range in the laboratory.

All with one goal:

Enabling our customers to run reliable, safe and efficient processes. This is why we commit ourselves to continuous innovation, first-class performance, and outstanding quality.

Engineering excellence is central to our ability to deliver products and solutions renowned for their quality, durability, and reliability. Innovative technology, high quality materials and extensive testing deliver unmatched performance - engineered and manufactured in Germany.

Together with you, our experts will find the best solution for your application and provide you with first-class service along the way.

BRAND (Shanghai) Trading Co., Ltd.
Shanghai, China

T +86 21 6422 2318
info@brand.com.cn
china.brand.com.cn

BRAND Scientific Equipment Pvt. Ltd.
Mumbai, India

T +91 22 42957790
customersupport@brand.co.in
www.brand.co.in

BRANDTECH® Scientific, Inc.
Essex, CT. United States of America

T +1 860 767 2562
info@brandtech.com
www.brandtech.com