

IKA

designed for scientists

TWISTER

ENGLISH

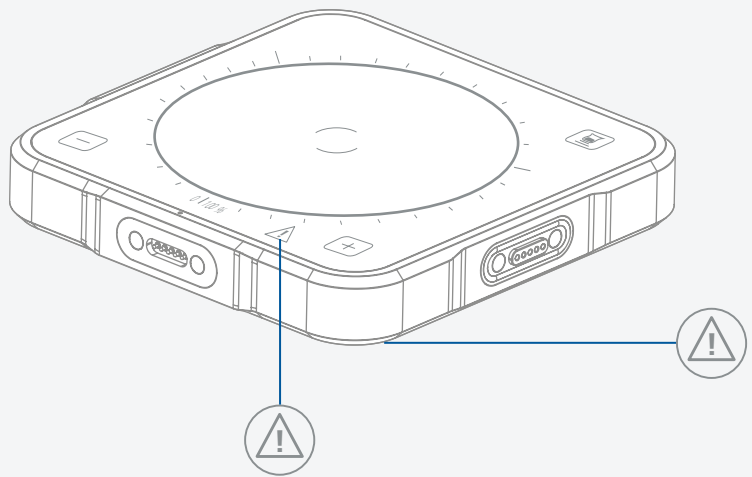









Fig. 1

	EU Declaration of conformity	6
	Explication of warning symbols	6
	Safety instructions	7
	Intended use	9
	Unpacking	9
	Assembly	10
	Operator panel and display	11
	Operation	13
	Maintenance and cleaning	23
	Accessories	23
	Warning / Errors	24
	Technical Data	26
	Warranty	27







EU Declaration of conformity

We declare under our sole responsibility that this product corresponds to the directives 2014/35/EU, 2006/42/EC, 2014/30/EU and 2011/65/EU and conforms with the following standards or normative documents: EN 61010-1, EN 61010-2-051, EN 61326-1, EN 60529 and EN ISO 12100. A copy of the complete EU Declaration of Conformity or further declarations of conformity can be requested at sales@ika.com.





Explication of warning symbols

/// Warning symbols

-  **Danger!** Indicates an (extremely) hazardous situation, which, if not avoided, will result in death, serious injury.
-  **Warning!** Indicates a hazardous situation, which, if not avoided, can result in death, serious injury.
-  **Caution!** Indicates a potentially hazardous situation, which, if not avoided, can result in injury.
-  **Notice!** Indicates practices which, if not avoided, can result in equipment damage.

/// General Symbols

- A** — Position number
Indicates device components relevant to actions.
-  Correct / result
Indicates the correct execution or the result of an action step.
-  Wrong
Indicates the incorrect execution of an action step.
-  Note
Indicates steps of actions that require particular attention.

Safety instructions



/// General information

- › **Read the operating instructions in its entirety before using the device and follow the safety instructions.**
- › Keep the operating instructions in a place where it can be accessed by everyone.
- › Ensure that only trained staff work with the device.
- › Follow the safety instructions, guidelines, occupational health and safety and accident prevention regulations.

Notice!

- › Pay attention to the marked sites in **Fig. 1**.

/// Device design

Caution!

- › Device surface is partially made of glass:
 - Glass surface can be damaged by impact.
 - If glass surface is damaged it could cause injury, don't use the device anymore.

Notice!

- › Set up the device in a spacious area on an even, stable, clean, non-slip, dry and fireproof surface.
- › The feet of the device must be clean and undamaged.
- › Keep the base plate clean.
- › Protect the device and accessories from bumps and impacts.
- › Check the device and accessories for damage before each use. Do not use damaged components.

/// Working with the device

Danger!

- › With substances capable of forming an explosive mixture, appropriate safety measures must be applied, e.g. working under a fume hood.
- › To avoid body injury and property damage, observe the relevant safety and accident prevention measures when processing hazardous materials.

Warning!

- › Only process media that will not react dangerously to the extra energy produced through processing. This also applies to any extra energy produced in other ways, e.g. through light irradiation.
- › Beware of hazards due to:
 - glass breakage,
 - incorrect container size,
 - overfilling of media,
 - unsafe condition of container.
- › Process pathogenic materials only in closed vessels under a suitable fume hood.

⊗ Caution!

- › Wear your personal protective equipment in accordance with the hazard category of the media to be processed. There may be a risk from:
 - splashing and evaporation of liquids,
 - ejection of parts,
 - release of toxic or combustible gases.
- › Reduce speed if:
 - medium splashes out of vessel because the speed is too high,
 - device is not running smoothly,
 - container moves on the base plate.
- › Please consider any possible contaminations and unwanted chemical reactions.
- › It may be possible for wear debris from rotating accessory parts to reach the material being processed.
- › When using PTFE-coated magnetic bars, the following has to be noted: Chemical reactions of PTFE occur in contact with molten or solute alkali metals and alkaline earth metals, as well as with fine powders of metals in groups 2 and 3 of the periodic system at temperatures above 300 °C – 400 °C. Only elementary fluorine, chlorotrifluoride and alkali metals attack it; halogenated hydrocarbons have a reversible swelling effect.
(Source: Römpps Chemie-Lexikon and "Ullmann", Volume 19)
- › The device has a vessel detection function. If this is switched on and a vessel is placed on the footprint, the motor function is activated. Liquid or other objects on the footprint, can also activate the motor function at this moment.

/// Accessories

- › Safe operation is guaranteed only with the use of original IKA accessories.
- › Observe the operating instructions of the accessories.

/// Power supply / Switching off the device

⚠ Warning!

- › The device will automatically restart in mode B following any interruption to the power supply.
- › The device must only be operated with the original power supply unit.
- › The power supply unit must be operated with the country-typical adapter.
- › The outlet for the mains plug must be easily accessible.
- › The device can only be disconnected from the mains supply by pulling out the mains plug or the connector plug.
- › Device setup, realignment and repositioning are only permitted in a de-energized state.

/// Maintenance

- › The device may only be opened by qualified and IKA approved experts. The device must be unplugged from the power supply before opening. Live parts inside the device may still be live for some time after unplugging from the power supply.

/// Disposal instructions

- › The device, accessories and packaging must be disposed of in accordance with local and national regulations.

Intended use

/// Use

- › The magnetic stirrer is suitable for mixing substances.

/// Area of use

- › Indoor environments similar to that a laboratory of research, teaching, trade or industry area.
- › The safety of the user cannot be guaranteed:
 - if the device is operated with accessories that are not supplied or recommended by the manufacturer,
 - if the device is operated improperly or contrary to the manufacture's specifications,
 - if the device or the printed circuit board are modified by third parties.

Unpacking

/// Unpacking

- › Unpack the device carefully. Any damage should immediately be reported to the carrier (mail, rail or freight forwarding company).

/// Scope of delivery

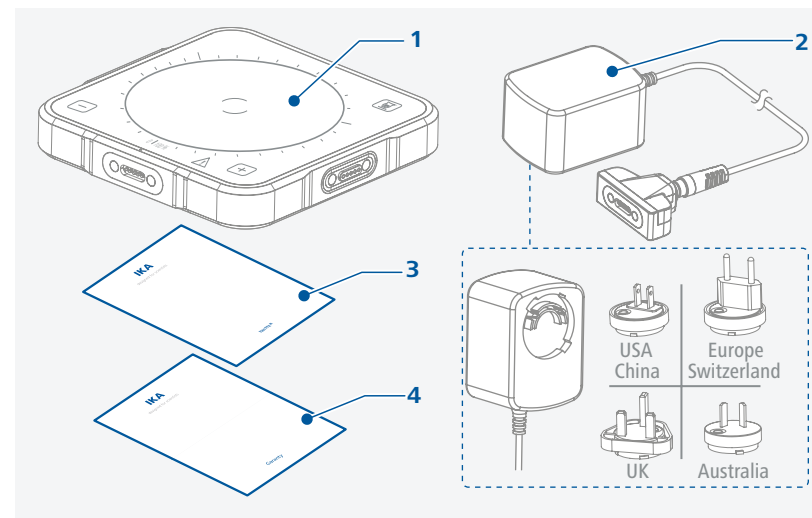

1	TWISTER
2	Power supply (with exchangeable adapters)

3	User guide
4	Warranty card



Assembly

Observe the ambient conditions (temperature, humidity, etc.) listed under "Technical Data".

- > Connect the device to a socket.
- > Place a magnetic rod in a vessel that is penetrable for magnetic field lines and fill the vessel with the medium to be processed. Then place the vessel on the center of the base plate.

⚠ Notice!

- > Before adding an additional stirring unit, please check your existing power adapter to ensure sufficient power!

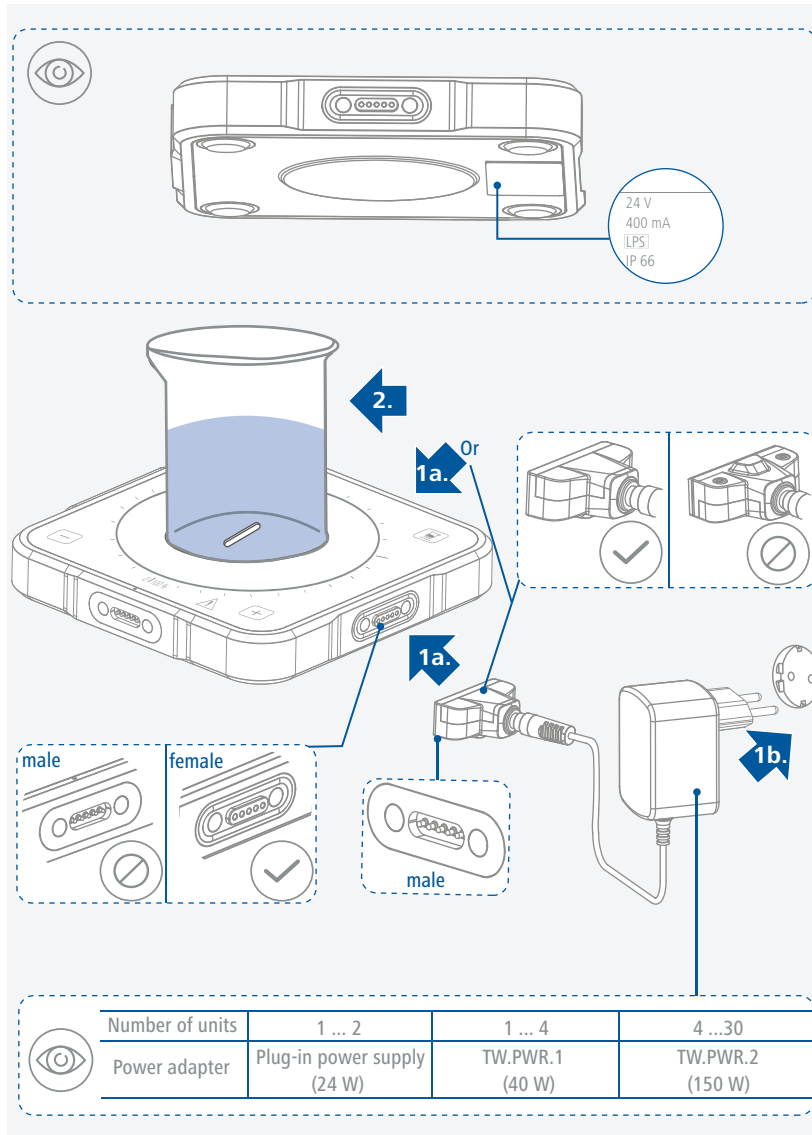

Operator panel and display

/// Operator panel

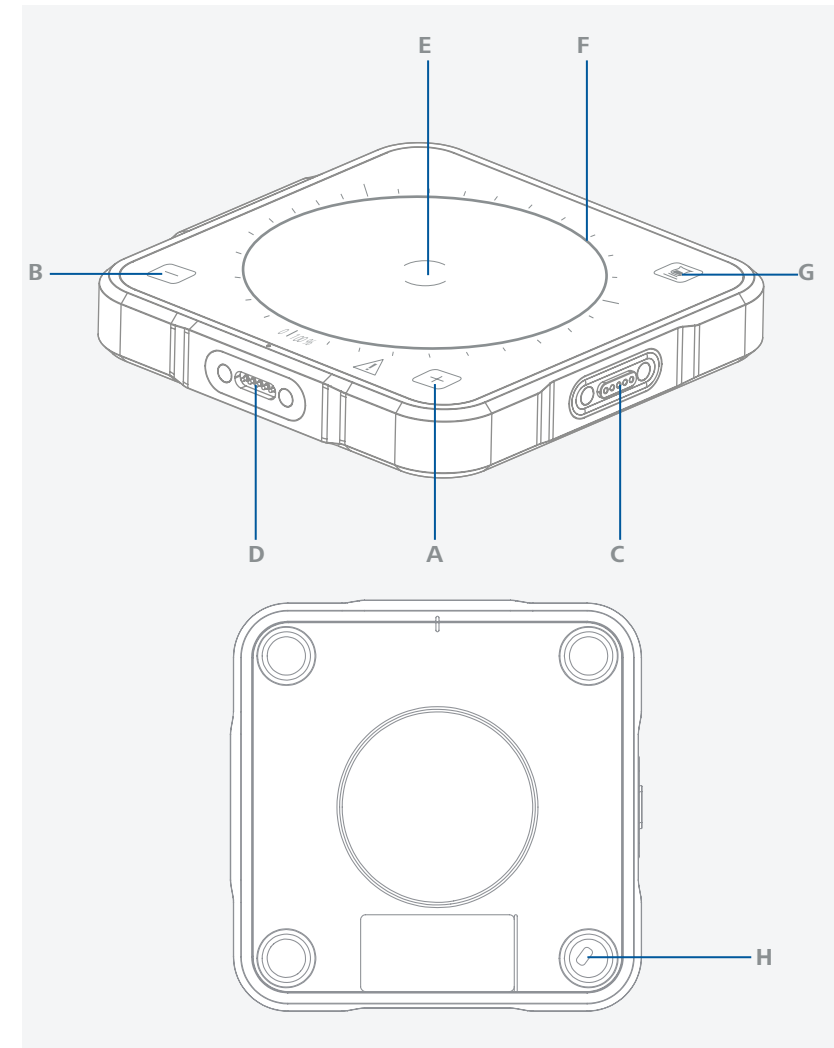

A	Button "+"	E	Working plate
B	Button "-"	F	Display
C	Input (connector female)	G	Button "Vessel detection"
D	Output (connector male)	H	USB Micro interface (only for firmware update)

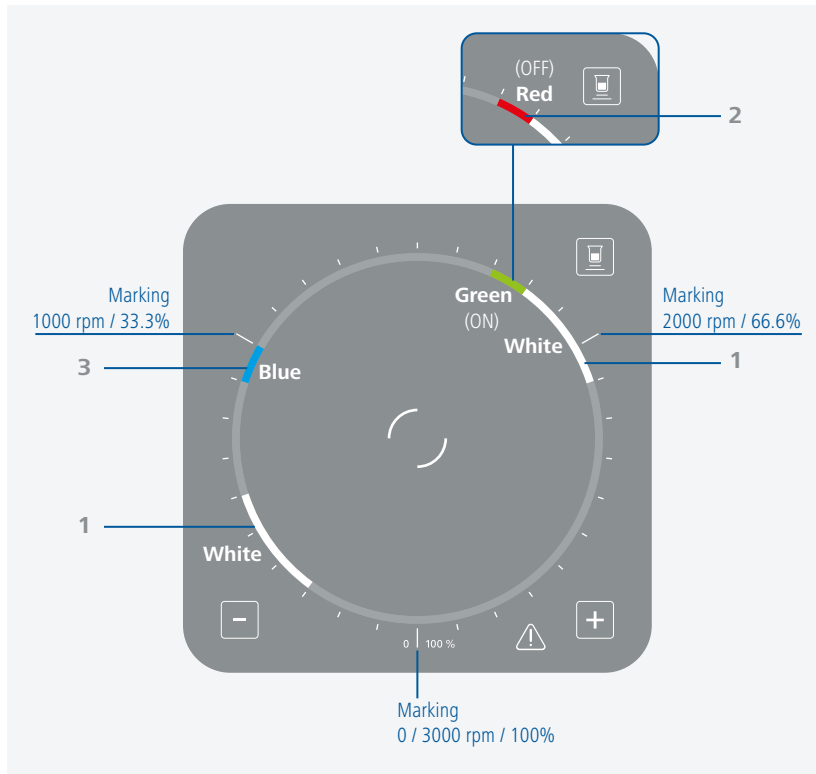

1	LED-light: White	Indicates "stand by"
2	LED-light: Green (ON) or Red (OFF)	Indicates "Vessel detection"
3	LED-light: Blue	Indicates "setpoint / actual speed" Blue-LED blinking = setpoint speed not reached Blue-LED lights up constantly = Setpoint speed reached

Operation

/// Start-up

⚠ Notice!

- › Several device settings can only be changed during the power-up process (LEDs start to light green).
- › The device have no power switch. The power-up process starts as soon as the plug-in power supply unit is connected.

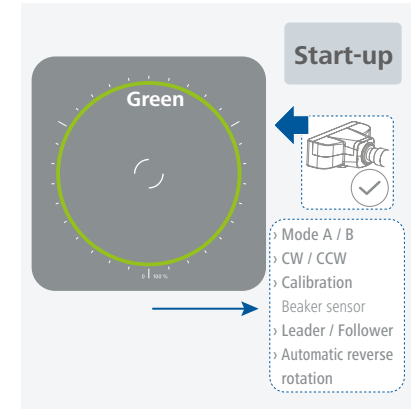

1. Operating mode A / B

- › Mode A
All settings will be stored if the device is switched OFF or disconnected from the power supply. The stirring function will be set to OFF when the device is powered on.
- › Mode B
All settings will be stored if the device is switched OFF or disconnected from the power supply. The stirring function will be set to ON (if the set value > 0 rpm) or OFF (if the set value = 0 rpm) when the device is powered on, depending on the previous status of the device.

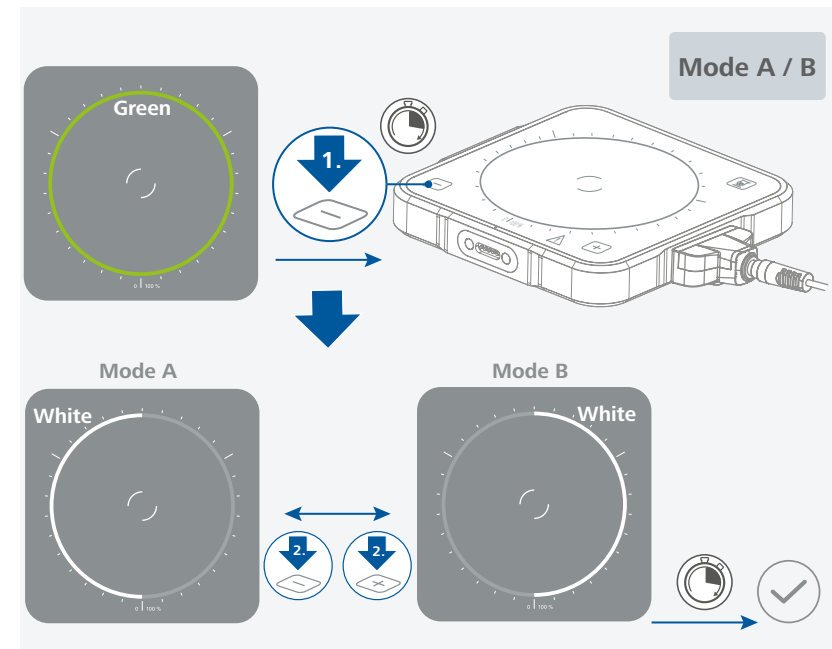

2. Direction of rotation of the motor [clockwise (CW) / counterclockwise (CCW)]

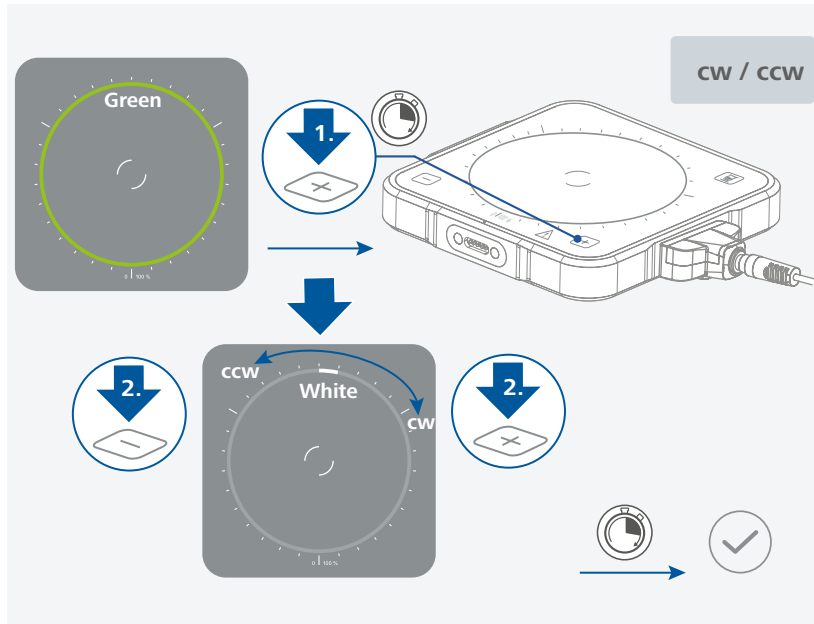

3.1 Calibration of the "Vessel detection" / Reset the calibration without vessel

- › Press and hold the "Vessel detection" button until the green LED stops blinking. This completes the calibration.
- › After calibration, this "Vessel detection" button can also be used as a motor start / stop button.

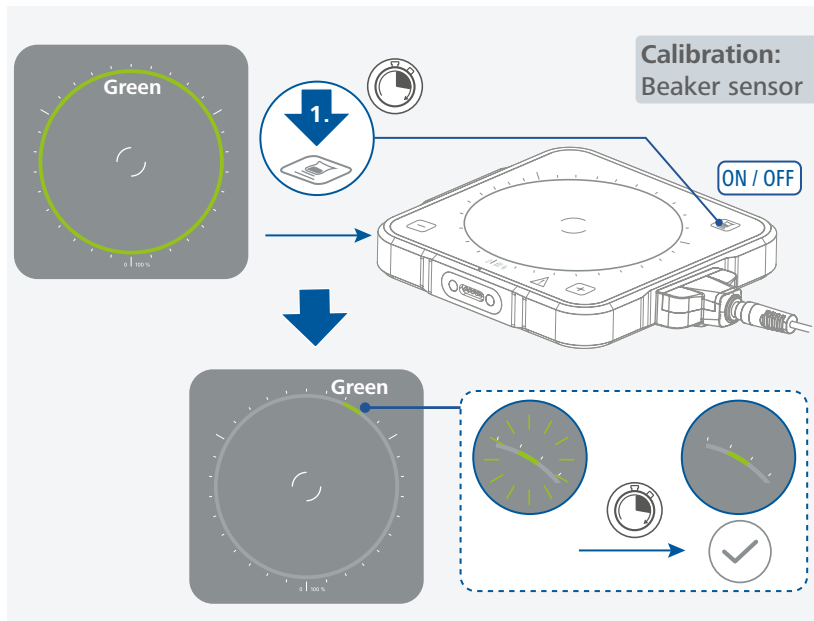

3.2 Calibration of the "Vessel detection" with the vessel:

- › Press and hold the "Vessel detection" button until the green LED stops flashing. This completes the calibration including the vessel or attachment.
- › After calibration, this "Vessel detection" button can also be used as a motor start / stop button.

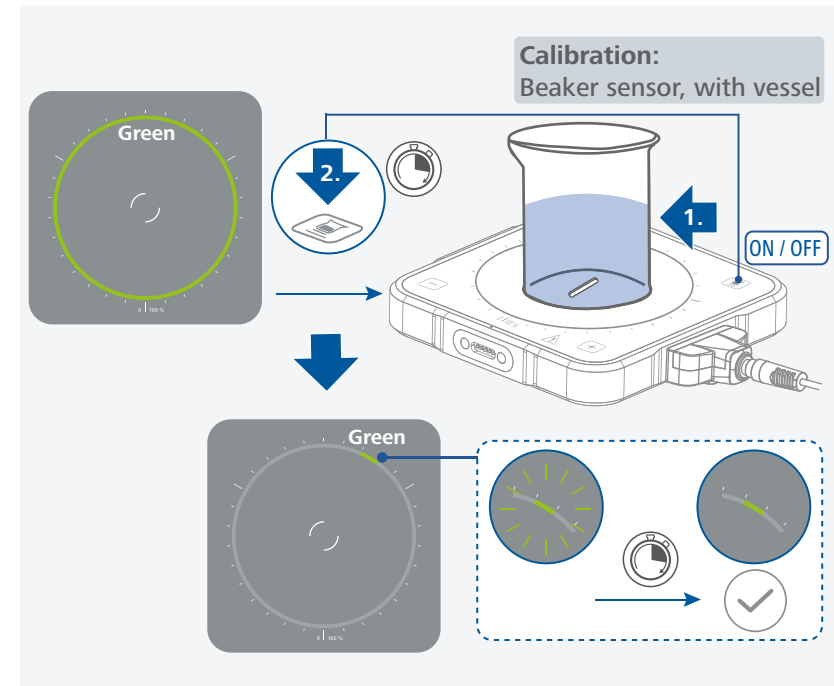

4. Device operates as leader or follower

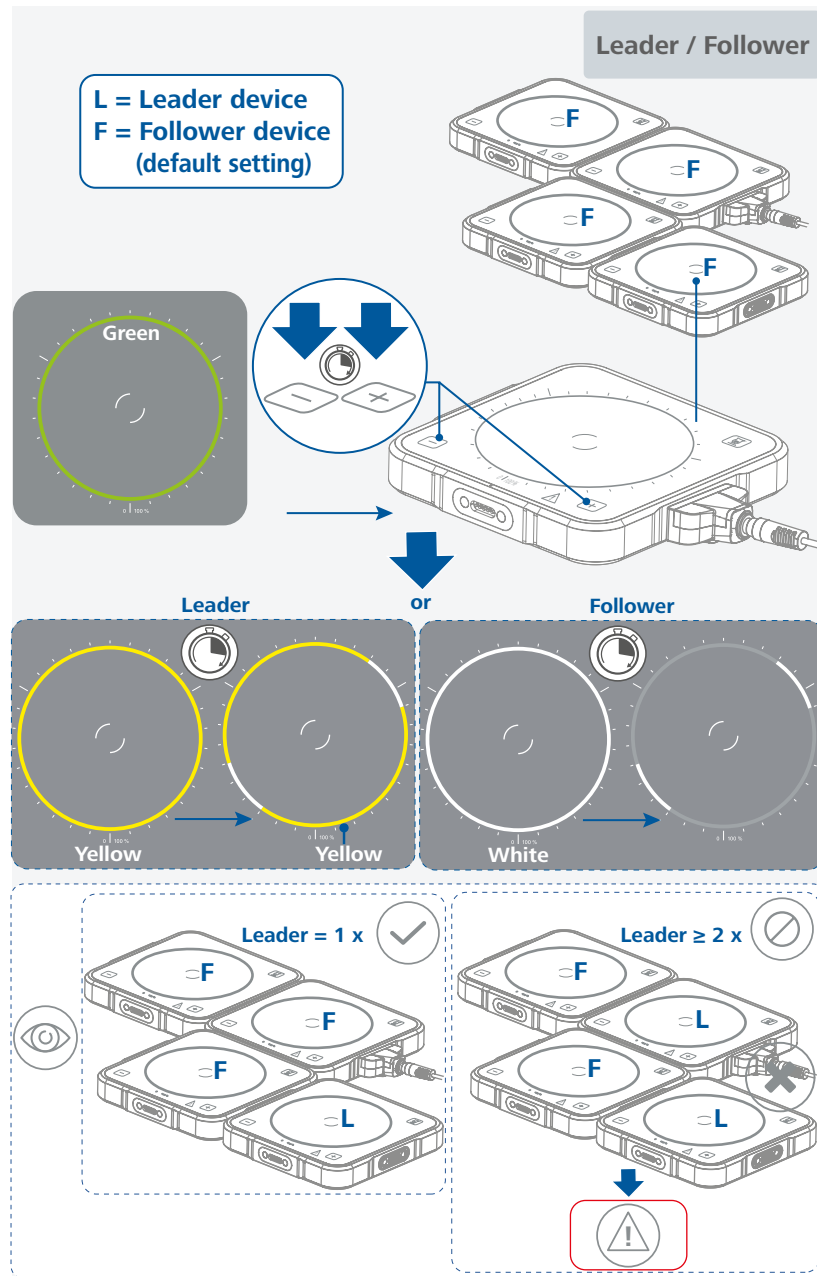

Notice!

- > If more than 1 leader device is detected at the moment of switching-on, all the devices configured as leaders will be reset to factory settings.
- > Operation of multiple-leader units in one system can damage the device!

5. Reverse rotation ON / OFF with interval time setting

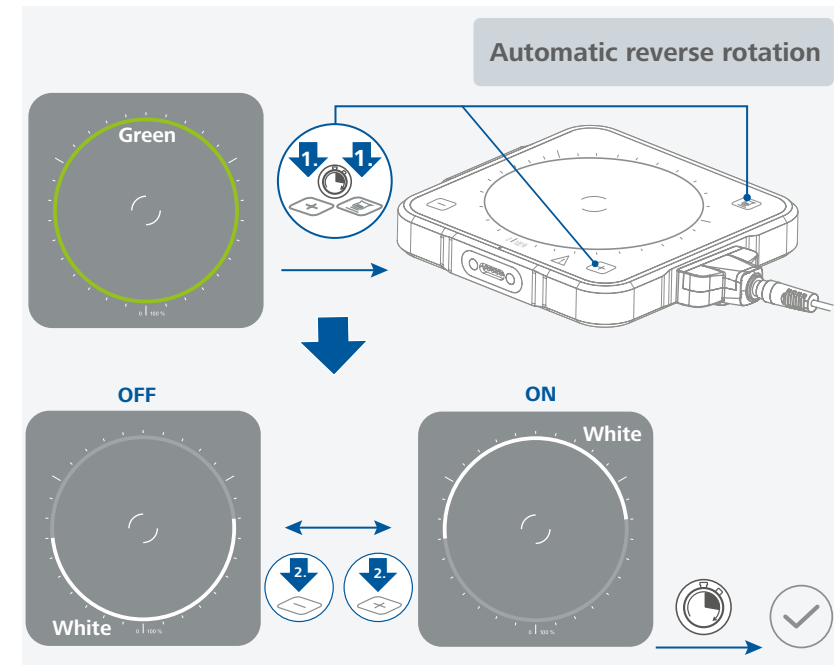

> Continue setting the interval time, after the reverse rotation function has been activated.

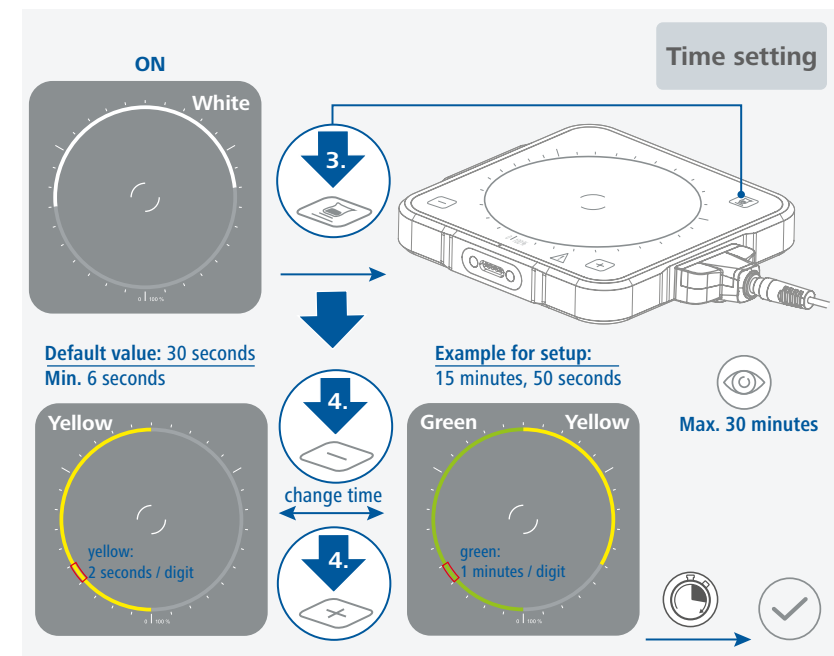

/// Stirring

- > Motor ON: White LEDs with tail, rotate
- > Motor OFF: White LEDs, do not rotate

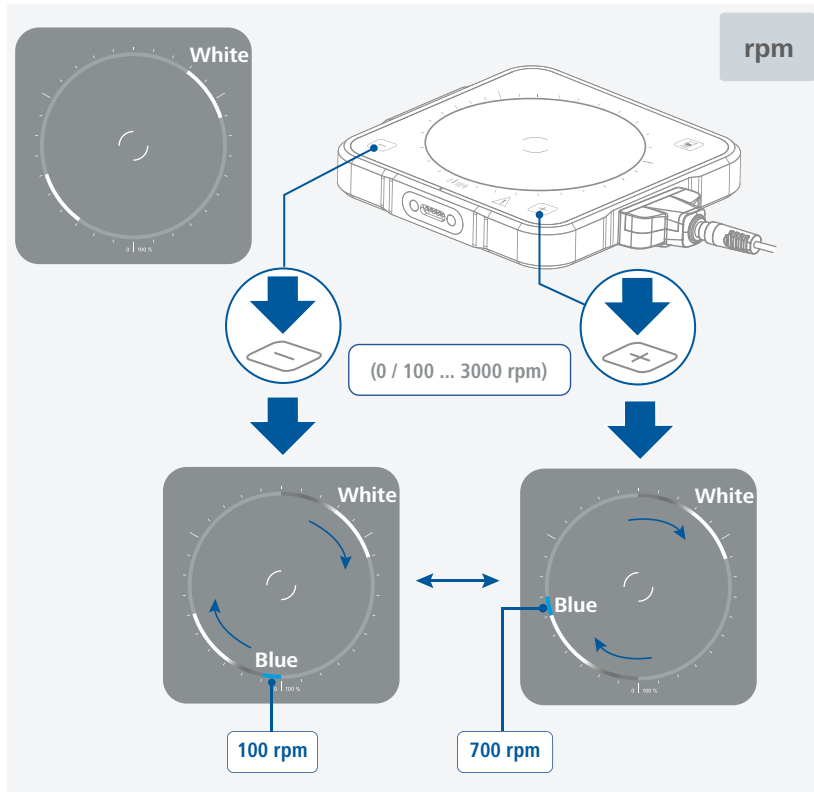

/// Vessel detection - activate / deactivate

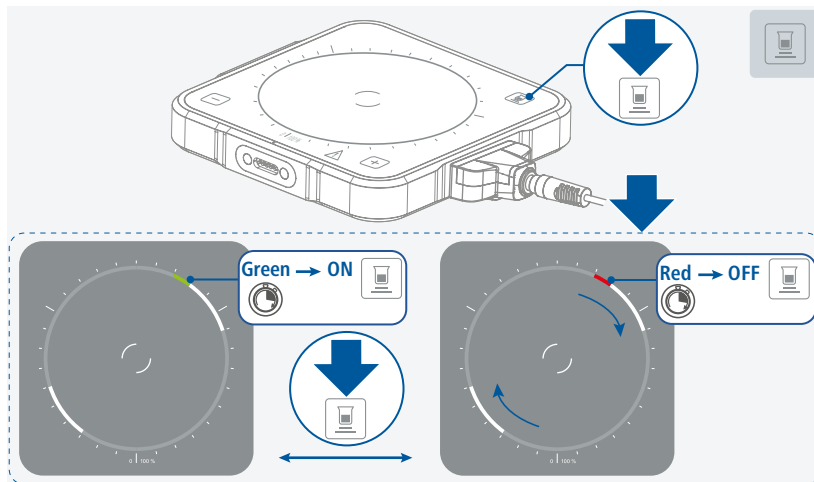

/// Selection of speed or torque display

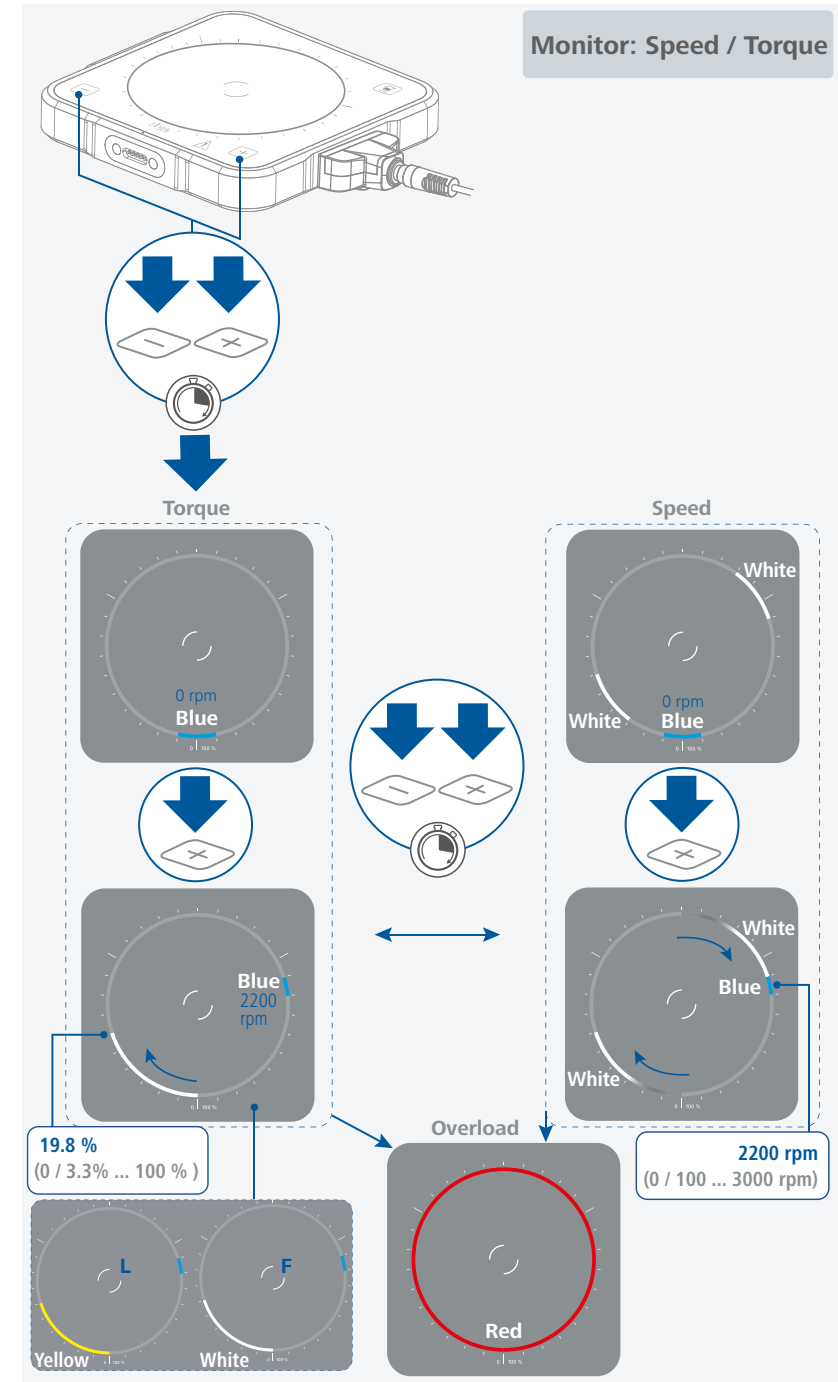

/// Operation in Leader / Follower mode

- > Once a "Leader" device has been configured in the stirring system, the "Follower" devices are controlled synchronously. All keys including the vessel detection of the "Follower" devices are deactivated.
- > This allows stirring operation of the "follower" devices across the permissible footprint, e.g. in the form of a larger container (as shown below) covering the working surface of the "follower" devices.

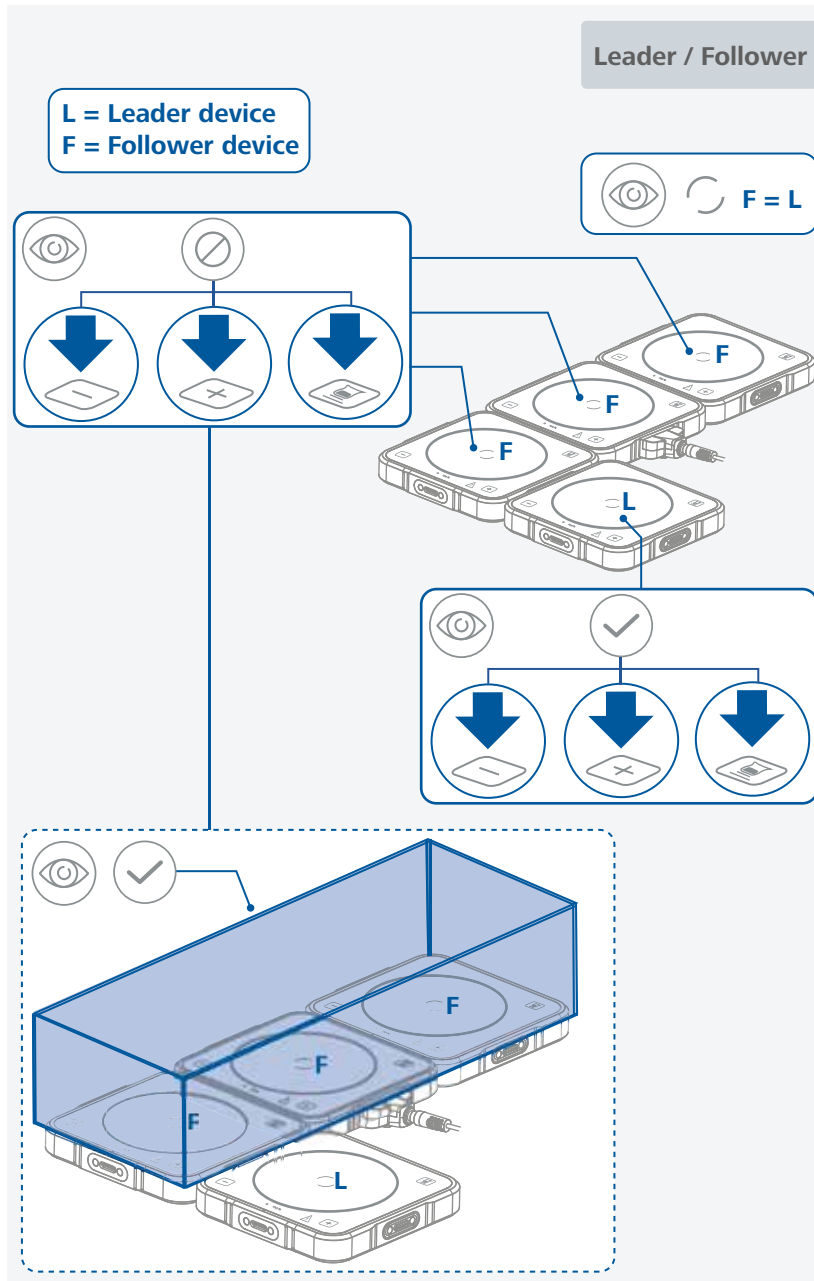

/// Operation in Leader / Follower mode: (L + F) > 4 x

- ⚠ Notice!**
- > If more than 4 devices [(L + F) > 4 x] are operated at the same time, a more powerful desktop power supply and an additional connector (adapter) are required. (see "Accessories")

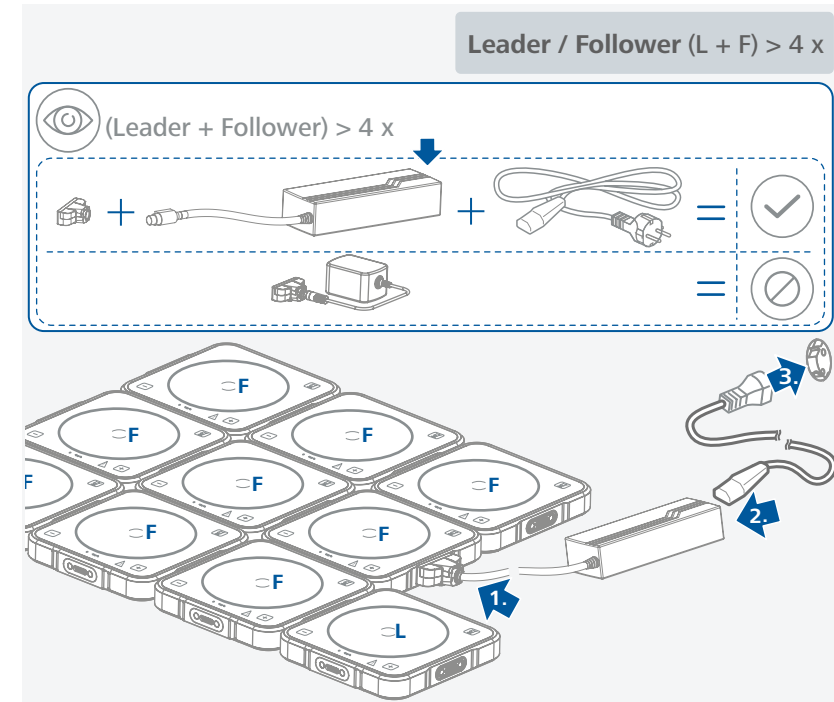

- > The following diagram gives a quick overview of the number of devices which can be used at the same time depending on the stirring volume, set speed and viscosity.

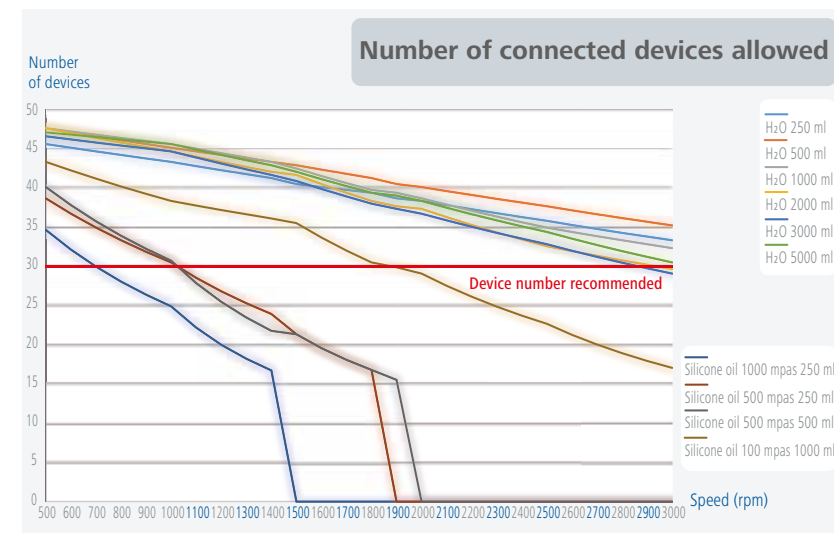

/// Arrangement of the device power plug

- › The device connector plug in a serially coupled device arrangement must be arranged centrally.
- › Contacting at the beginning or end in a serial device arrangement must be avoided. In addition, only one device connector plug may be used.

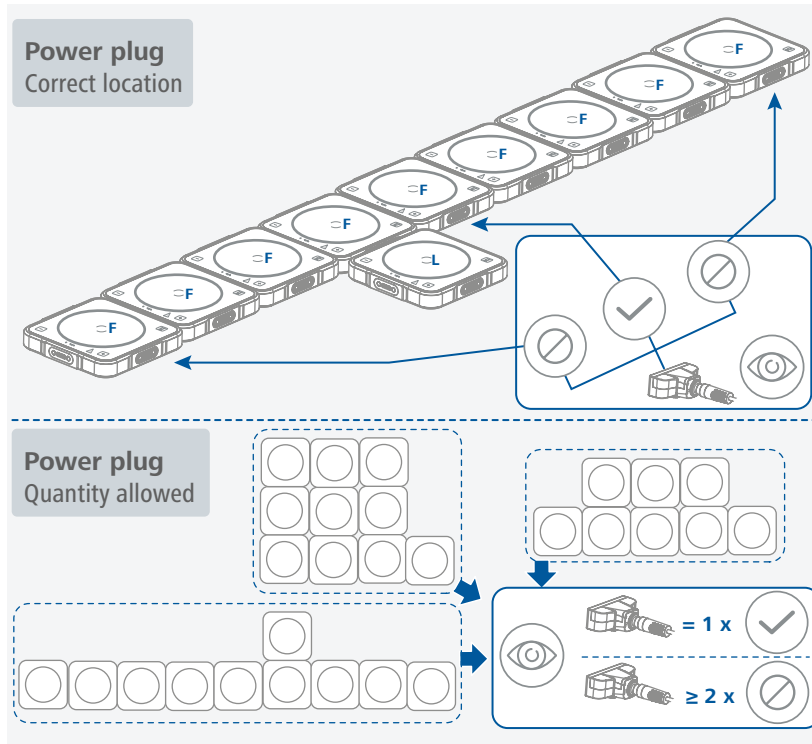

/// Device arrangement with the extension cable (see "Accessories")

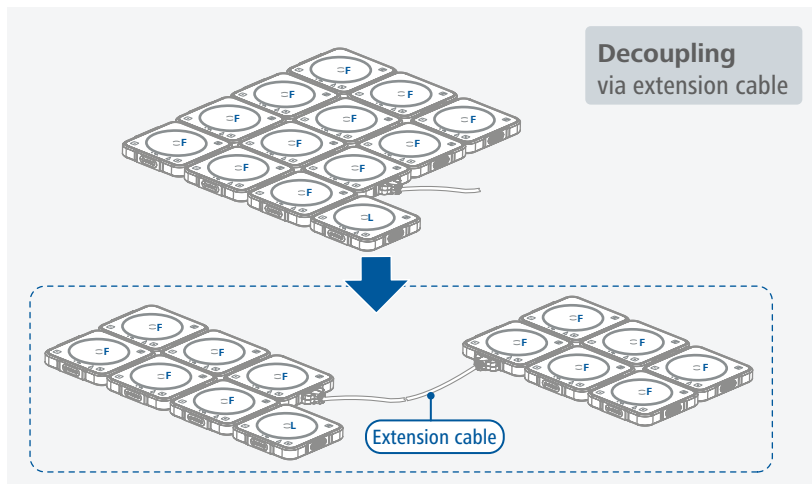

Maintenance and cleaning

- › The device is maintenance-free. It is only subject to the natural wear and tear of components and their statistical failure rate.

/// Cleaning

- › For cleaning disconnect the mains plug!
- › Use only cleaning agents which have been approved by IKA to clean IKA devices. These are: water (containing surfactant) and isopropyl alcohol.
- › Wear protective gloves during cleaning the devices.
- › Electrical devices may not be placed in the cleansing agent for the purpose of cleaning.
- › Do not allow moisture to get into the device when cleaning.
- › Before using another than the recommended method for cleaning or decontamination, the user must ascertain with IKA that this method does not destroy the device.

/// Spare parts order

- › When ordering spare parts, please give:
 - device type.
 - serial number, see type plate.
 - position number and description of spare part, see www.ika.com.

/// Repair

- › Please only send devices in for repair that have been cleaned and are free of materials that might present health hazards.
- › For repair, please request the "**Safety Declaration (Decontamination Certificate)**" from IKA or use the download printout of it from IKA website at www.ika.com.
- › If your appliance requires repair, return it in its original packaging. Storage packaging is not sufficient when sending the device - also use appropriate transport packaging.

Accessories

- › For accessories see www.ika.com.

Warning / Errors

1. Motor overload

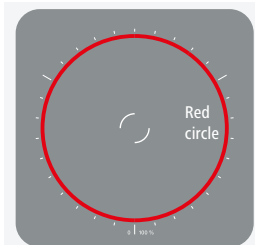

If the allowed motor power is overloaded by the user application, the device automatically reduces the speed value step by step until the motor can reach a stable operating state.

The warning is indicated by slow or fast flashing of the display:

- Fast flashing: Immediate reduction of the speed.
- Slow flashing: Slow reduction of the speed

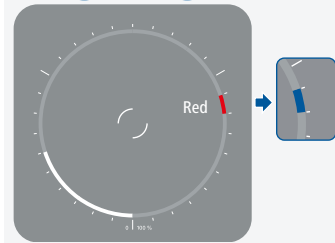

The automatic reduction of the speed is indicated by the blue setpoint LED lighting up in red.

The user has to confirm one-time the button “-” or “+” to reset that state.

When working in Leader / Follower mode, this state can only be deleted at the Follower units by a restart (power interruption).

See also the following explanation: **Behaviour in case of motor overload of a follower or leader unit**

Behaviour in case of motor overload of a follower unit:

If the motor power of a follower unit is overloaded, the unit may deviate from the specified speed of the leader unit. The priority is therefore the limitation of the maximum motor power.

Behaviour in case of motor overload of a Leader unit:

If the motor power of a leader unit is overloaded, but does not apply to the follower units, they still follow the reduced preset speed of the leader unit. Priority is therefore given to the leader unit and its maximum permissible speed specification.

2. Maximum internal device temperature exceeded

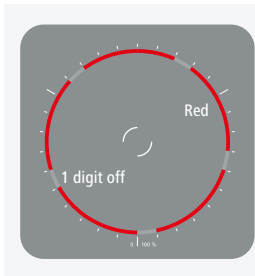

Inner housing Temperature > 70°C:
Display shows the warning by slow flashing.
Device operation continues.

Inner housing Temperature > 75°C:
Display shows the warning by fast flashing.
Device operation continues.

Inner housing Temperature > 80°C:
Display shows the error steady (no blinking) and the buzzer beeps.
Device operation interrupted. The Motor stops.

Allow the device to cool down.

3. Permitted minimum input voltage is too low

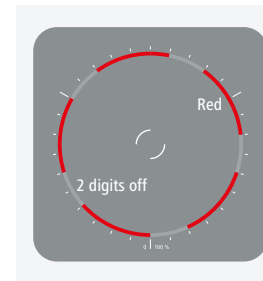

Display shows the following warning indication.

Solutions:

- Change the position of the device.
- Reduce the number of the units.
- Change the position of the power plug.

Extended behaviour in Leader / Follower mode with regarding to the permissible minimum input voltage:

If the Leader unit detects a too low input voltage, it will lead to a reduction of the stirring speed, same as explained at warning 1. The Leader will reduce the speed until a stable operating state was established.

4. Maximum input current allowed overshoot

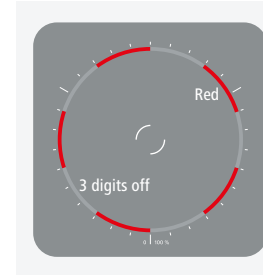

Display shows the following warning indication.

Solutions:

- Limit the stirring load
- Reduce the number of the units.

Extended behaviour in Leader / Follower mode with regarding to the permissible maximum input power:

If the Leader unit detects a too high input power, it will lead to a reduction of the stirring speed, same as explained at warning 1. The Leader will reduce the speed until a stable operating state was established.

5. Motor error

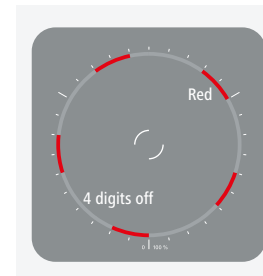

Display shows the following error indication.

Solutions:

- Contact the Service department.



Technical data

General data	
Nominal voltage	24 VDC
Max. power input	10 W
Power input standby	2 W
Motor rating output	5 W
Self-heating of the plate by max. stirring (RT: 22 °C / duration:1 h)	+ 6 K
USB interface	Optional (only for firmware updating by service department)
Set-up plate material	Glass
Set-up plate dimensions	124 x 124 mm
Dimensions (W x D x H)	135 x 135 x 24 mm
Weight	600 g
Permissible ambient temperature	+5 ... +40 °C
Permissible relative humidity	80 %
Protection class according to DIN EN 60529	IP 66
Contamination level	2
Overvoltage category	II
Operation at a terrestrial altitude	max. 2000 m above sea level
Stirring function	
Number of stirring positions	1
Stirring quantity max. (H ₂ O)	5 l
Speed display	LED
Speed setting	Touch key
Speed range	0 / 100 ... 3000 rpm, 0 / 3.3% ... 100 %
Speed variation (no load, nominal voltage, at 1500 rpm, ambient temperature + 25 °C)	± 2 %
Speed setting accuracy	100 rpm
Stirring bar length	10 ... 30 mm
Torque range monitor	0 ... 100% / 0 ... 30 Segments
Display accuracy - torque	3.33% / 1 Segment
Automatic reverse rotation	yes
Time setting min.	6 seconds / 1 minute
Time setting max.	30 minutes
Power supply	
Input	100 ... 240 VAC; 50 / 60 Hz
Output	24 VDC; 40 / 24 W (LPS, limited power source)
Protection class	II

› Subject to technical changes!

Warranty

- › In accordance with IKA warranty conditions, the warranty period is 24 months. For claims under the warranty please contact your local dealer. You may also send the device direct to our factory, enclosing the delivery invoice and giving reasons for the claim. You will be liable for freight costs.
- › The warranty does not cover worn out parts, nor does it apply to faults resulting from improper use, insufficient care or maintenance not carried out in accordance with the instructions in this operating manual.



designed for scientists

IKA-Werke GmbH & Co. KG

Janke & Kunkel-Straße 10,
79219 Staufen, Germany
Phone: +49 7633 831-0
eMail: sales@ika.de

USA

IKA Works, Inc.
Phone: +1 910 452-7059
eMail: sales@ika.net

KOREA

IKA Korea Ltd.
Phone: +82 2 2136 6800
eMail: sales-lab@ika.kr

BRAZIL

IKA Brasil
Phone: +55 19 3772 9600
eMail: sales@ika.net.br

MALAYSIA

IKA Works (Asia) Sdn Bhd
Phone: +60 3 6099-5666
eMail: sales.lab@ika.my

CHINA

IKA Works Guangzhou
Phone: +86 20 8222 6771
eMail: info@ika.cn

POLAND

IKA Poland Sp. z o.o.
Phone: +48 22 201 99 79
eMail: sales.poland@ika.com

JAPAN

IKA Japan K.K.
Phone: +81 6 6730 6781
eMail: info_japan@ika.ne.jp

INDIA

IKA India Private Limited
Phone: +91 80 26253 900
eMail: info@ika.in

UNITED KINGDOM

IKA England LTD.
Phone: +44 1865 986 162
eMail: sales.England@ika.com

VIETNAM

IKA Vietnam Company Limited
Phone: +84 28 38202142
eMail: sales.lab-vietnam@ika.com

THAILAND

IKA Works (Thailand) Co. Ltd.
Phone: +66 2059 4690
eMail: sales.lab-thailand@ika.com

TURKEY

IKA Turkey A.Ş.
Phone: +90 216 394 43 43
eMail: sales.turkey@ika.com

Discover and order the fascinating products of IKA online:
www.ika.com

