

memmert

Operating manual



HPPeco IPPecoplus

Constant climate chamber HPPeco
Peltier cooled incubator IPPeco plus

About this manual

Purpose and target audience

This manual describes the construction, function, transport operation and maintenance of constant climate chambers HPPeco and cooled incubators IPPecoplus. It is intended for use by trained personnel of the owner, who have the task of operating and/or maintaining the respective appliance. If you are asked to work on the appliance, read this manual carefully before starting. Familiarise yourself with the safety regulations. Only perform work that is described in this manual. If there is something you do not understand, or certain information is missing, ask your manager or contact the manufacturer. Do not do anything without authorisation.

Versions

The appliances are available in different configurations and sizes. If specific equipment features or functions are available only for certain configurations, this is indicated at the relevant points in this manual. The functions described in this manual refer to the latest firmware version. Due to individual configurations and sizes, illustrations in this manual may be slightly different to the actual appearance. Function and operation are identical.

Other documents to be observed:

- For operation of the appliance with MEMMERT AtmoCONTROL, observe the separate software manual. To open the AtmoCONTROL software manual, click on "Help" in the AtmoCONTROL menu bar.
- For service and repair work, observe the separate service manual

Storage and resale

This operating manual belongs with the appliance and should always be stored where persons working on the appliance have access to it. It is the owner's responsibility to ensure that persons who are working on or are going to work on the appliance know where to find the operating manual. We recommend that it is always stored in a protected location close to the appliance. Make sure that the operating manual is not damaged by heat or humidity. If the appliance is resold or transported and then set up again at a different location, the operating manual must remain with it. The current version of this operating manual in PDF format is also available for download from www.memmert.com/de/downloads/

Manufacturer address and customer service

MEMMERT GmbH + Co. KG
Willi-Memmert-Str. 90-96
91186 Büchenbach
Germany

Phone: +49 (0)9122 925-0
Fax: +49 (0)9122 14585
E-mail: sales@memmert.com
Internet: www.memmert.com

Customer service:
Hotline: +49 (0)9171 9792 911
Service fax: +49 (0)9171 9792 979
Email: service@memmert.com

For service enquiries, please always specify the appliance number given on the type plate.

Content

1. Safety	5
1.1 Terms and signs used.....	5
1.2 Product safety and dangers.....	6
1.3 Requirements of the operating personnel	7
1.4 Responsibility of the owner	7
1.5 Intended use	7
1.6 Changes and alterations.....	8
1.7 Behaviour in case of malfunctions and irregularities	8
1.8 Switching off the appliance in an emergency.....	8
2. Construction and description	9
2.1 Design	9
2.2 Description	10
2.3 Working range of constant climate chambers HPPeco.....	11
2.4 Material	12
2.5 Electrical equipment	12
2.6 Connections and interfaces.....	12
2.7 Designation (nameplate).....	13
2.8 Technical data.....	14
2.9 Applied directives and standards	15
2.10 Ambient conditions.....	15
2.11 Scope of delivery.....	15
3. Delivery, Transport and Setting Up	16
3.1 Safety.....	16
3.2 Delivery.....	16
3.3 Transport.....	17
3.4 Unpacking	17
3.5 Disposing of packaging material	17
3.6 Storage after delivery	17
3.7 Setting up.....	18
3.8 Installation options	19
3.9 Level and secure the device against rolling away (Sizes 1400 and 2200)	20
3.10 Tilt protection.....	21
3.11 Adjusting doors	21
4. Putting into operation	22
4.1 Connecting the appliance	22
4.2 Switching on.....	24
5. Operation and control	25
5.1 Operating personnel.....	25
5.2 Operating the appliance	27
5.3 Operating modes.....	29
5.4 Monitoring function.....	34
5.5 Ending operation	39



6. Malfunctions, warning and error messages	40
6.1 Warning message of the monitoring function	40
6.2 Power failure	42
7. Menu mode	43
7.1 Overview	43
7.2 Basic operation in menu mode using the example of language selection	44
7.3 Setup	45
7.4 Date and Time	49
7.5 Calibration	50
7.6 Program	55
7.7 Sound	56
7.8 Protocol	57
7.9 USER ID	58
8. Maintenance and Servicing	59
8.1 Cleaning	59
8.2 Regular maintenance	60
8.3 Repairs and service	60
9. Storage and disposal	61
9.1 Storage	61
9.2 Disposal	61

1. Safety















1.1 Terms and signs used

In this manual and on the appliance itself, certain common terms and signs are used to warn you of possible dangers or to give you hints that are important in avoiding injury or damage. Observe and follow these notes and regulations to avoid accidents and damage. These terms and signs are explained below.

1.1.1 Terms used

 WARNING	Warns of a dangerous situation that might lead to death or serious injuries.
 CAUTION	Warns of a dangerous situation that might lead to moderate or minor injuries.
NOTICE	Warns of material damage

1.1.2 Signs used

Symbol	Meaning	Symbol	Meaning
	Caution - hazard area		Gases / vapours
	Caution - current		Prohibited - do not wear
	Warning - flammable substances		Prohibited - do not enter
	Caution - hot surfaces		Prohibited - do not tip
	Danger of explosion		Note - disconnect the mains plug
	Note - observe manual		Note - wear gloves
	Note - wear safety shoes		Note - observe number of people

1.2 Product safety and dangers

The appliances described in this manual are technically sophisticated, manufactured using high-quality materials and subject to many hours of testing in the factory. They reflect the state of the art and comply with recognised technical safety regulations. However, there are still risks involved, even when the appliances are used as intended. These are described below.

⚠ WARNING



Live components may be exposed once the covers have been removed. Touching these can lead to an electric shock. Disconnect the mains plug before removing any covers. Work on the electrical system must only be performed by qualified electricians.

⚠ WARNING



Leaving the door open during operation can cause the appliance to overheat or pose a fire hazard. Do not leave the door open during operation.

⚠ WARNING



When loading the appliance with an unsuitable load, poisonous or explosive vapours or gases may be produced. This could cause the appliance to explode, and persons could be severely injured or poisoned. The appliance may only be loaded with materials / test objects that do not emit any poisonous or explosive vapours when heated up.

⚠ WARNING



With appliances above a specific size, you could become accidentally locked inside, which could put you at risk of death. Do not climb into the appliance!

⚠ CAUTION



Depending on operation, the surfaces in the interior of the appliance and the chamber load may still be very hot after the appliance is switched off. Touching these surfaces can cause burns. Wear heat-resistant protective gloves or wait until the appliance cools down after switching off before touching.

1.3 Requirements of the operating personnel

The appliance may only be operated and maintained by persons who are of legal age and have been instructed accordingly. Personnel who are to be trained, instructed or who are undergoing general training may only work with the appliance under the continuous supervision of an experienced person. Repairs may only be performed by qualified electricians. The regulations in the separate service manual must be observed.

1.4 Responsibility of the owner

The owner of the appliance

- is responsible for the flawless condition of the appliance and for it being operated in accordance with its intended use
- is responsible for ensuring that persons who are to operate or service the appliance are qualified to do this, have been instructed accordingly and are familiar with the operating instructions at hand
- must know about the applicable guidelines, requirements and operational safety regulations, and train staff accordingly
- is responsible for ensuring that unauthorised persons have no access to the appliance
- is responsible for ensuring that the maintenance plan is adhered to and that maintenance work is properly carried out
- has to ensure that the appliance and its surroundings are kept clean and tidy, for example through corresponding instructions and inspections
- is responsible for ensuring that personal protective clothing is worn by operating personnel, e.g. work clothes, safety shoes and protective gloves.

1.5 Intended use

Constant climate chambers HPPeco and cooled incubators IPPecoplus may be used exclusively for temperature and climate testing of materials and substances in the context of the procedures and specifications described in this manual. Any other use is improper and may result in hazards and damage.

The appliance is not explosion-proof (does not comply with the German occupational health and safety regulation VBG 24). The appliance may only be loaded with materials and substances which cannot form any toxic or explosive vapours at the set temperature and which cannot explode, burst or ignite.

The appliance may not be used to dry, vaporise or brand materials for which the purchasing or its components constitutes a risk of fire and/or explosion, especially if the solvents of these materials could form an explosive mixture when combined with air. If there is any doubt as to the composition of materials, they must not be loaded into the appliance. Potentially explosive gas-air mixtures must not form, neither in the chamber nor in the direct vicinity of the appliance.

1.6 Changes and alterations

No unauthorised changes or alterations may be made to the appliance. No parts may be added or inserted which have not been approved by the manufacturer.

Unauthorised changes or alterations result in the CE declaration of conformity losing its validity, and the appliance may no longer be operated.

The manufacturer is not liable for any damage, danger or injuries that result from unauthorised changes or alterations, or from non-compliance with the provisions in this manual.

1.7 Behaviour in case of malfunctions and irregularities

The appliance may only be used in a flawless condition. If you as the operator notice irregularities, malfunctions or damage, immediately take the appliance out of service and inform your superior.

1.8 Switching off the appliance in an emergency

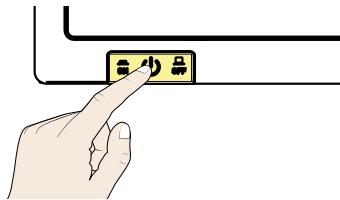

Press the main switch on the ControlCOCKPIT and disconnect the power plug. This disconnects the appliance from the power supply at all poles.

2. Construction and description

2.1 Design

Description	Overview - HPP110ecoplus
1. ControlCOCKPIT with capacitive function keys and LCD displays	
2. Main switch	
3. Turn control with confirmation key	
4. Peltier element	
5. Inner glass door	
6. Slide-in units	
7. Peltier dehumidifier	
8. Nameplate	
9. Door-handle	
10. USB interface	

Description	Overview - HPP1400plus
1. ControlCOCKPIT with capacitive function keys and LCD displays	
2. Main switch	
3. Turn control with confirmation key	
4. Slide-in units	
5. Heated full-sight glass door	
6. Lockable castors with extendable feet	
7. Nameplate	
8. Door-handle	
9. USB interface	

2.2 Description

Appliance size 110 to 1060	Description
HPPeco & IPPecoplus	The appliance can heat the interior up to +70 °C and cool it down to +5 °C. Low-noise, long-life and energy-saving Peltier cooling and heating technology is used for this. In heating operation, a part of the required energy is extracted from the surroundings (heat pump principle).
HPPeco	<p>Additionally, the humidity in the interior can be regulated between 10% rh and 90% rh (rh = relative humidity). The humidity is increased by the evaporation of water from a tank which is then fed into the interior and reduced by condensation on a Peltier module.</p> <p>Optionally, the appliance can be equipped with a light module, making it possible to adjust the interior lighting in steps of 1 %.</p>
Appliance size 1400 to 2200	Description
HPPeco & IPPecoplus	The appliance can heat the interior up to 60 °C and cool it down to 15 °C. Low-noise, long-life and energy-saving Peltier cooling and heating technology is used for this. In heating operation, a part of the required energy is extracted from the surroundings (heat pump principle).
Constant climate chambers HPPeco	Additionally, the humidity in the interior can be regulated between 15% rh and 80% rh (rh = relative humidity). The humidity is increased by the evaporation of water from a tank which is then fed into the interior and reduced by condensation on a Peltier module.

2.3 Working range of constant climate chambers HPPeco

The temperature-humidity diagram specifies at what range of temperature and humidity a permanent, condensation-free operation of the constant climate chamber HPPeco is possible.

If the chamber is in operation at the upper limit or outside the working range for long periods, puddles of water may form inside the chamber and water may force its way out of the door seal.

Climate points in the threshold range of the climate diagram can only be reached with the correct dehumidification time interval. For optimal time interval setting, see chapter 7.3.7

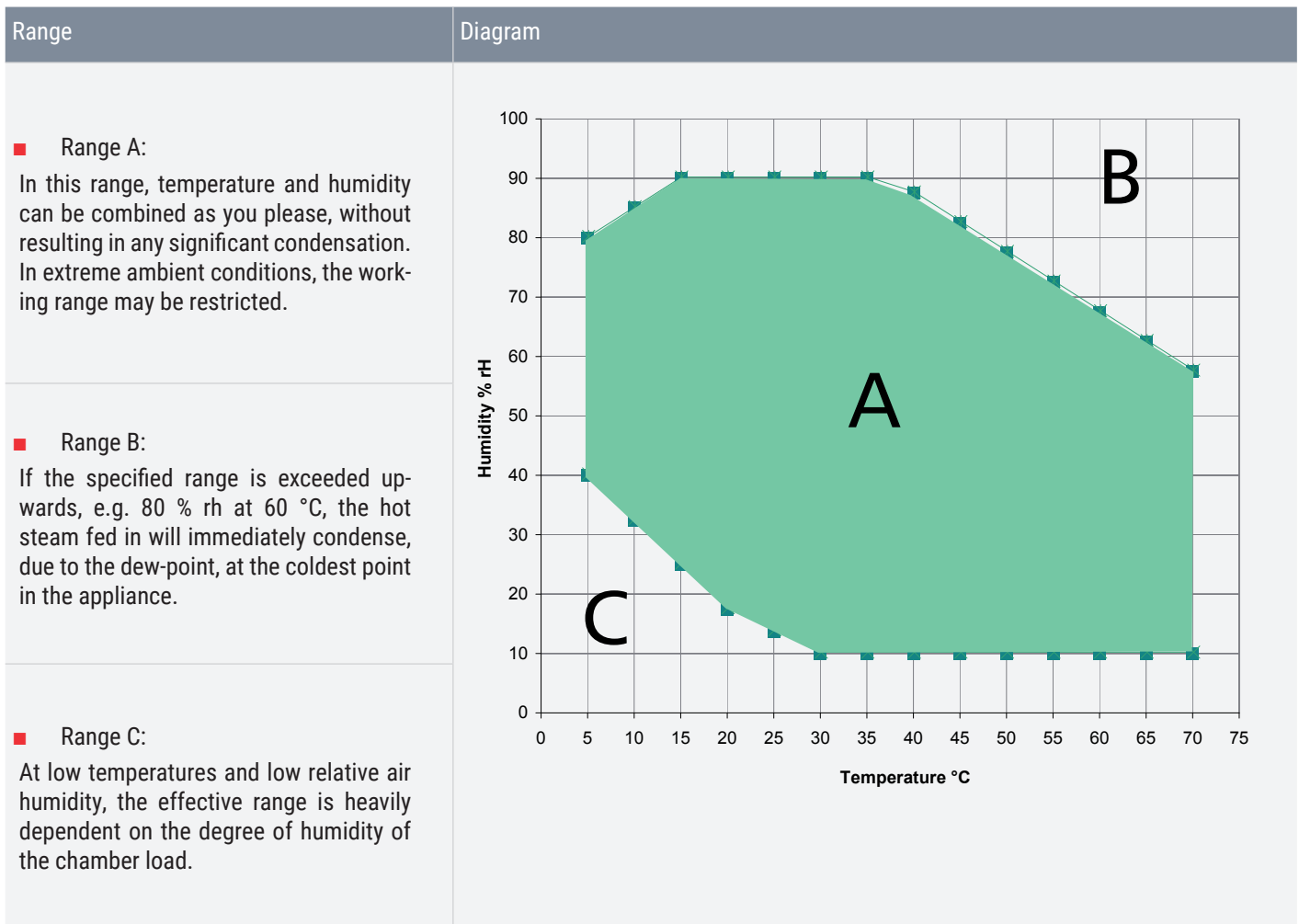

2.4 Material

These appliances fulfil the current requirements of the RoHS Directive. For more information about this and about the Material Compliance of these Memmert appliances in general, please visit our homepage at www.memmert.com.

Components	Material
Housing (lid + side panel)	Stainless steel 1.4016 - ASTM 430
Housing (rear panel)	Galvanised steel plate
Interior (incl. covers)	Stainless steel 1.4301 - ASTM 304
Accessories (perforated sheet, steel grid)	Stainless steel 1.4301 - ASTM 304
Door seal	Silicone
Inner glass door	Glass



The chamber load for the appliance must be carefully checked for chemical compatibility with the materials mentioned.

2.5 Electrical equipment

- Operating voltage and current consumption: See nameplate
- Protection class I, i.e. operating insulation with PE conductor in accordance with EN 61010
- Protection type IP 20 acc. to EN 60 529
- Interference suppression acc. to EN 55011 class B
- Appliance fuse: Safety fuse 250 V/15 A, quick-blow
- The temperature controller is protected with a miniature fuse 100 mA (160 mA at 115 V)

2.6 Connections and interfaces

2.6.1 Electrical connection

This appliance is intended for operation on an electrical power system with a system impedance Z_{max} at the point of transfer (service line) of a maximum of 0.292 Ohm. The operator must ensure that the appliance is operated only on an electrical power system that meets these requirements. If necessary, you can ask your local energy supply company what the system impedance is. Observe the country-specific regulations when connecting (e.g. in Germany DIN VDE 0100 with residual current circuit breaker).

2.6.2 Communication interfaces

The interfaces are intended for appliances which meet the requirements of IEC 60950-1.

USB interface

The appliance is fitted by default with a USB port in accordance with the USB specification. With this you can:

- transfer software stored on a USB storage medium to the appliance
- export protocol logs from the appliance to a USB storage medium
- transfer user ID data stored on a USB storage medium to the appliance

Ethernet interface

Via Ethernet interface, the appliance can be connected to a network, so that programmes created with the AtmoCONTROL software can be transferred to the appliance and protocols read out.

For identification purposes, each appliance connected must have its own unique IP address. Setting the IP address is described in chapter 7.3.2.

You will find a description of how to transfer programs via Ethernet in the enclosed AtmoCONTROL manual.

The appliance can be directly connected to a computer/laptop using an optional USB to Ethernet converter.

2.7 Designation (nameplate)

The nameplate provides information about the appliance model, manufacturer and technical data. It is attached to the front of the appliance, on the right behind the door.

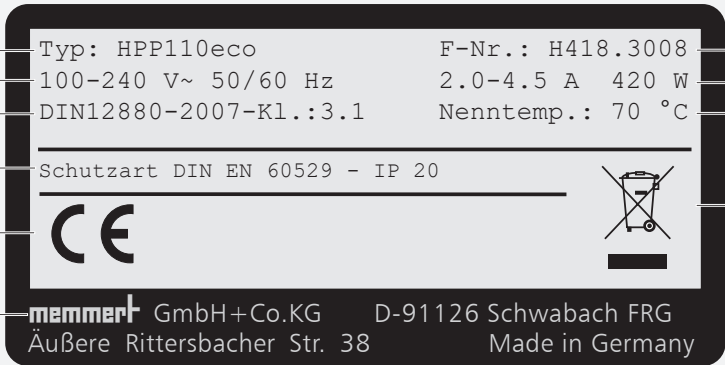
Description	Overview
1. Type designation	 <p>1 — Typ: HPP110eco F-Nr.: H418.3008 — 10</p> <p>2 — 100-240 V~ 50/60 Hz 2.0-4.5 A 420 W — 9</p> <p>3 — DIN12880-2007-K1.:3.1 Nenntemp.: 70 °C — 8</p> <p>4 — Schutzart DIN EN 60529 - IP 20 — 7</p> <p>5 — CE</p> <p>6 — memmert GmbH+Co.KG D-91126 Schwabach FRG Äußere Rittersbacher Str. 38 Made in Germany</p>
2. Operating voltage	
3. Applicable standard	
4. Protection type	
5. CE conformity	
6. Address of manufacturer	
7. Disposal note	
8. Temperature range	
9. Connection / power ratings	
10. Appliance number	

2.8 Technical data

Appliance size			110	260	410	750	1060	1400	2200	
Appliance width (D)		mm	745	824		1224		1435	2157	
Appliance height (E)		mm	864	1183	1720			1913		
Appliance depth (F)		mm	555	655		755	1005	905		
Depth of door lock		mm	56							
Chamber width (A)		mm	560	640		1040		1250	1972	
Chamber height (B)		mm	480	800	1200			1450		
Chamber depth (C)		mm	400	500		600	850	750		
Chamber volume		mm	108	256	384	749	1060	1360	2140	
Weight (including packaging)		kg	102	173	213	279	424	639	730	
Power	HPPeco	W	420	700		1400		2000		
	IPPeco	W	320	600		1300		1900		
Current consumption	HPPeco	115 V	A	4,5	7,5		14,5		-	
		230 V	A	2	3		6		10,5	
	IPPeco	115 V	A	3,5	6,5		13,5		-	
		230 V	A	1,5	2,5		5,5		10	
max number steel grids/ perforated sheet		unit	5	9	14		28		42	
max load per steel grid/ perforated sheet		kg	20		30		20	30		
max load per appliance		kg	150	200			250			
Temperature	Adjustment range		°C	+5 bis +70				+15 bis +60		
	Adjustment precision		K	0,1						
Humidity adjustment range		%	10 bis 90				15 bis 80			

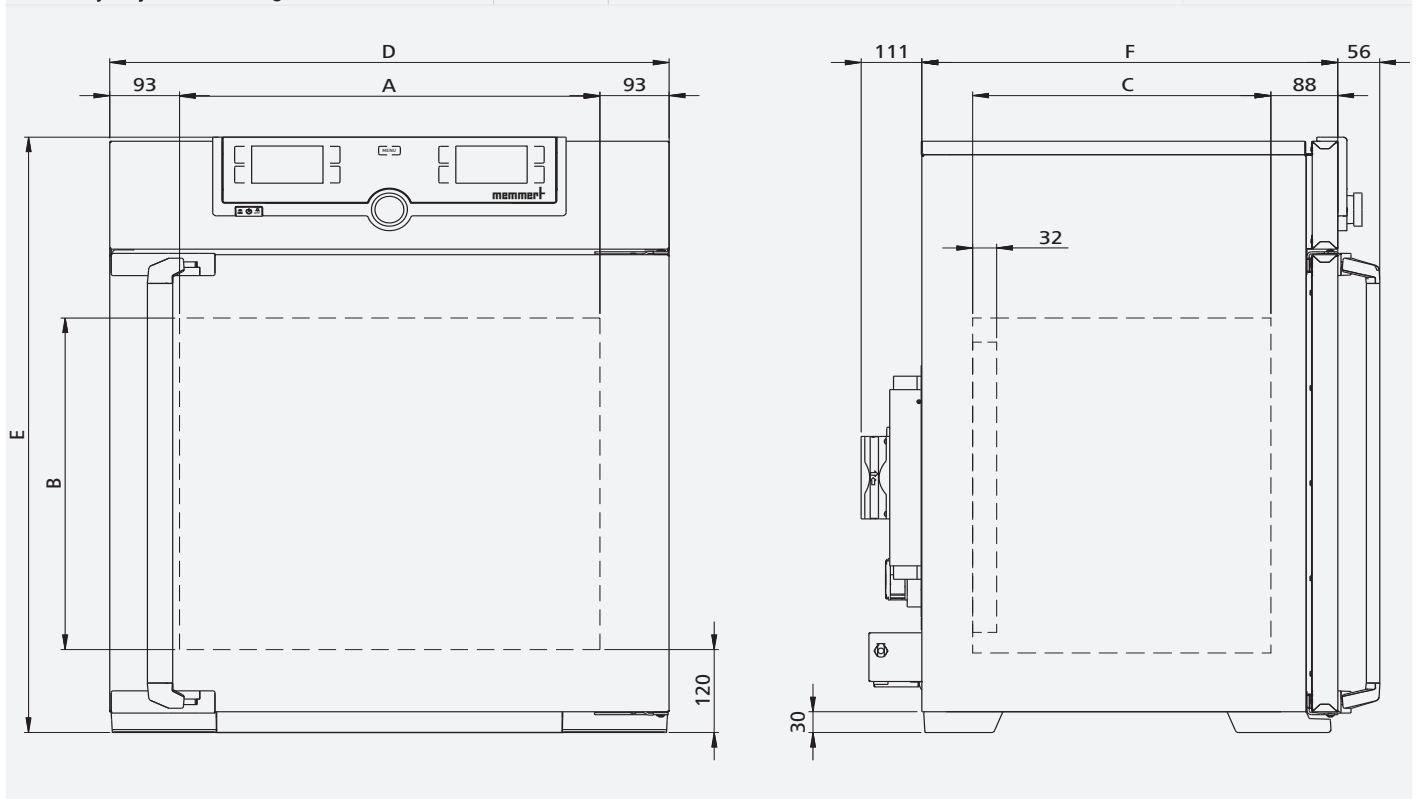

2.9 Applied directives and standards



Based on the standards and guidelines listed in the following, the products described in this manual have received a CE label from the company Memmert:

- Directive 2004/108/EC amended (Directive of the European Parliament and of the Council on the approximation of the laws of the Member States relating to electromagnetic compatibility)
- Directive 2006/95/EC amended (Directive of the European Parliament and of the Council on the harmonisation of the laws of Member States relating to electrical equipment designed for use within certain voltage limits)

2.9.1 Declaration of conformity

You can download the EC declaration of conformity of the appliance online under

www.memmert.com/de/downloads/

2.10 Ambient conditions

Ambient criteria	
Ambient temperature	+16 °C to +40 °C
Air humidity	max. 70 % rh non-condensing
Overvoltage category	II
Pollution degree	2
Altitude of installation	max. 2,000 m above sea level

- The appliance may only be used in enclosed areas and under the ambient conditions listed below
- The appliance may not be used in areas where there is a risk of explosion. The ambient air must not contain any explosive dusts, gases, vapours or gas-air mixtures. The appliance is not explosion-proof.
- Heavy dust production or aggressive vapours in the vicinity of the appliance could lead to sedimentation in the interior and, as a consequence, could result in short circuits or damage to electrical parts. For this reason, sufficient measures to prevent large clouds of dust or aggressive vapours from developing should be taken.

2.11 Scope of delivery

Standard delivery

- Power cable
- Tilt protection
- Steel grid (number depends on appliance size)
- USB storage medium with software and AtmoCONTROL manual
- Operating manual
- Calibration certificate

In addition for constant climate chambers HPPeco

- Water tank with connection hose
- Tank holder (only for appliances of size 410 and up)

Optional accessories

- USB- Ethernet converter. This makes it possible to connect the Ethernet connection interface to the USB port of a computer/laptop.
- Reinforced steel grid with a load capacity of 60 kg (size 110 and up)

3. Delivery, Transport and Setting Up

3.1 Safety

⚠ WARNING



The appliance could fall over and seriously injure you. Never tilt the appliance. Only transport in upright position and without load (except standard accessories such as steel grids or shelves). Appliances with castors always have to be moved by two people.

⚠ CAUTION



Because of the heavy weight of the appliance, you could injure yourself if you try to lift it. At least four people are needed to carry appliance sizes 110 and 260. Appliances larger than that may not be carried, but must be transported using a manual pallet jack or forklift truck.

110 and 260



410 and up



⚠ CAUTION



You may get your hands or feet squashed when transporting and installing the appliance. Wear protective gloves and safety boots. Only grasp the appliance at the sides of the base:

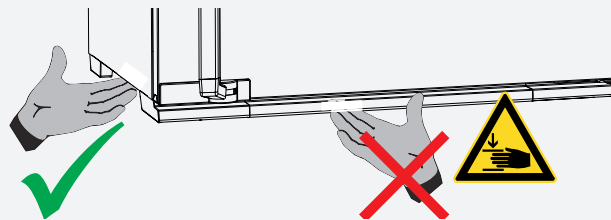

3.2 Delivery

Appliance size 110 to 1060

- The appliance is packed in cardboard and is delivered on a wooden palette.

Appliance size 1400 to 2200

- The appliance is packaged in a wooden crate and delivered on a wooden pallet.

3.3 Transport

The appliance can be transported in three ways:

- With a forklift truck or a manual pallet jack; move the forks of the truck entirely under the pallet
- On its own castors, in case of the corresponding configuration, for which the catch on the (front) castors must be released

3.4 Unpacking

- To avoid damage, do not unpack the appliance until you reach the installation site.
- Remove the cardboard packaging by pulling it upwards or carefully cutting along an edge or unscrew and remove wooden crate

3.4.1 Checking for completeness and transport damage

- Check the delivery note to ensure that the scope of delivery is complete
- Check the appliance for damage

If you notice deviations from the delivery note, damage or irregularities, do not put the appliance into operation but inform the haulage company and the manufacturer.

3.4.2 Remove the transportation lock

- Remove the transportation lock. It is located between the door hinge, door and frame and has to be removed after opening the door.

3.5 Disposing of packaging material

- Dispose of the packaging material (cardboard, wood, foil) in accordance with the applicable disposal regulations for the respective material in your country

3.6 Storage after delivery

If the appliance is first to be stored after delivery:

- Observe storage conditions, see chapter 9.1

3.7 Setting up

⚠ WARNING



Due to its centre of gravity, the appliance can fall over to the front and injure you or other people. Always attach the appliance to a wall with the tilt protection. In case there is not enough space, do not put the appliance into operation and do not open the door. Contact the Memmert service.

3.7.1 Preconditions

The installation site must be flat and horizontal and able to reliably bear the weight of the appliance. Do not place the appliance on a flammable surface.

Depending on the model (see nameplate), a 230 V or 115 V power connection must be available at the installation site.

The distance between the wall and the rear of the appliance must be at least 15 cm. The clearance from the ceiling must not be less than 20 cm and the side clearance from walls or nearby appliances must not be less than 5 cm. Sufficient air circulation in the vicinity of the appliance must be guaranteed at all times.

For appliances with castors, these need to be positioned in forward direction at all times.

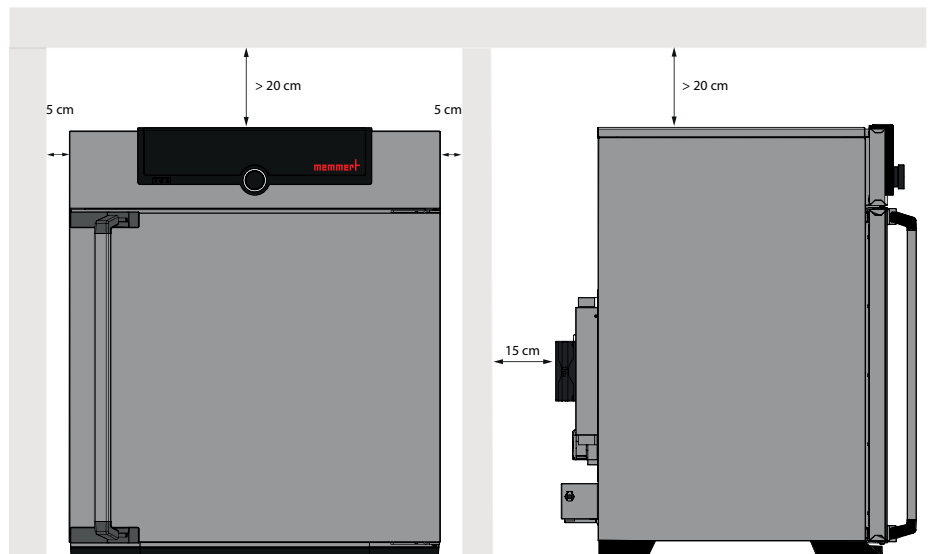

3.8 Installation options

Setting up		Comments	110	260 410	750 1060	1400 2200
Bottom			✓	✓	✓	✓
Table		Check the load capacity first	✓	✗	✗	✗
Stacked		two appliances maximum; mounting material (feet) provided	✓	✗	✗	✗
Sub frame		with/without castors	✓	✓	✗	✗
Castor frame			✓	✓	✗	✗
Height adjustable feet			✓	✓	✓	✓

3.9 Level and secure the device against rolling away (Sizes 1400 and 2200)

The height of the appliance can be adjusted using the heavy-duty castors attached to the bottom of the appliance.
It can also be secured against rolling away or being shifted. To do this, the feet must be extended.

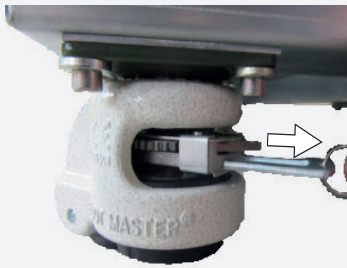

1. To unlock the adjustment mechanism, pull out the ratchet lever on the ring

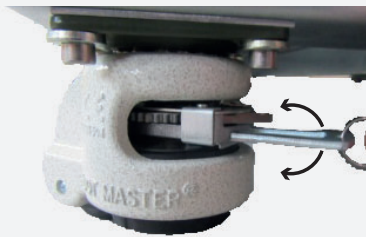

2. To retract and extend the stand, actuate the ratchet lever

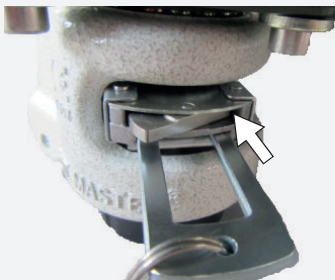

The direction of movement (up/down) can be adjusted using the rocker above the ratchet lever:

- Press in the rocker on the right side to extend the stand with the ratchet lever

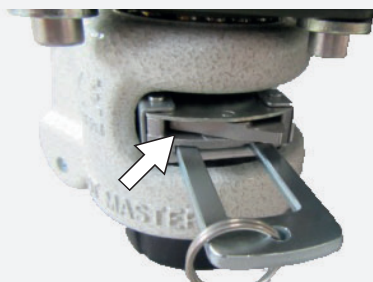

- Press in the rocker on the left side to retract the stand with the ratchet lever

In the end position, push in the ratchet lever again to fix the stand.

Use a spirit level to ensure that all four feet are adjusted to the same height.

To move the cabinet, all four feet must be retracted.



3.10 Tilt protection

Attach the appliance to a wall with the tilt protection. The tilt protection is included in the scope of delivery.

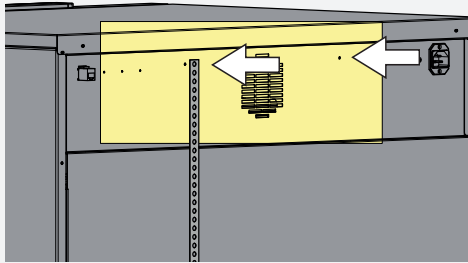

1. Tighten the tilt protection onto the back of the appliance as illustrated.

i Depending on the ambient conditions, the tilt protection can be fastened to either of the two holes in the appliance.

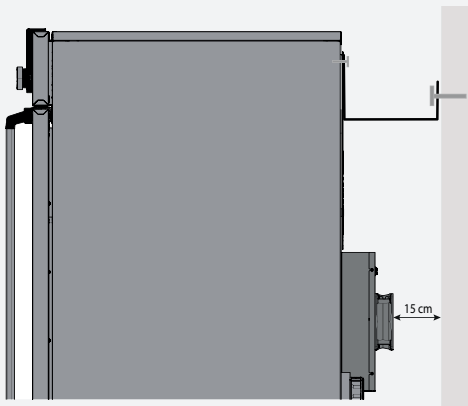

2. Bend the tilt protection upwards by 90° in the desired distance to the wall (observe the minimum distance to the wall).
3. Drill a hole, insert a dowel and screw the tilt protection to a suitable wall.

3.11 Adjusting doors

You can adjust the doors if necessary, for example if they are warped due to uneven flooring. There are two adjusting screws each at the top and the bottom of each door for this purpose. First, adjust the setting at the top of the door and, if this is not sufficient, adjust the screws at the bottom of the door.

i

Door adjustment is also available as a service video:
<https://www.memmert.com/de/downloads/media/service-videos/>

1. Open the door.
2. Loosen the screws.
3. Adjust the position of the door.
4. Tighten the screws again.
5. Check the position of the door.
6. Readjust if required.

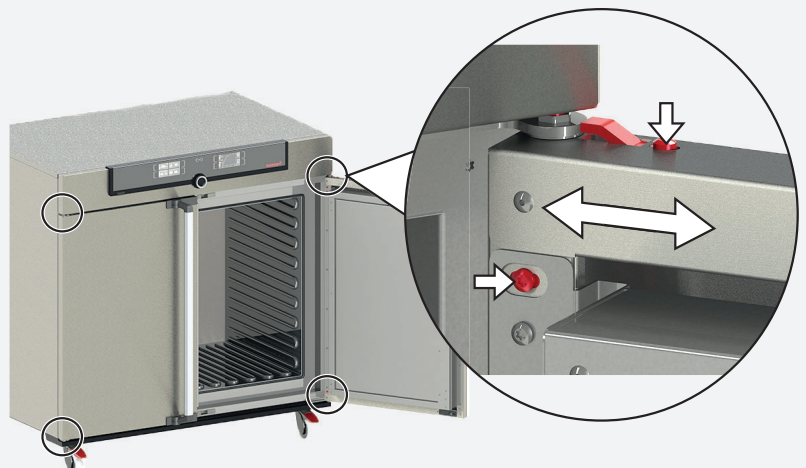

4. Putting into operation

⚠ WARNING



Condensation in the electrical components may cause short circuits. After transporting or storing the device under humid conditions, remove it from its packaging and let it ventilate for at least 24 hours in normal environmental conditions. Do not connect the device to the mains power during this time.

⚠ CAUTION



When putting the appliance into operation for the first time, do not leave it unattended until it has reached a steady state.

4.1 Connecting the appliance

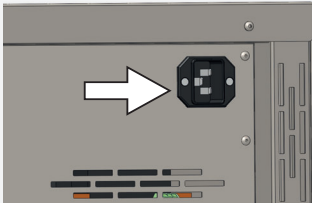

Observe the country-specific regulations when making connections (e.g. DIN VDE 0100 with earth leakage circuit breaker, in Germany). Observe the connection and power ratings (see name plate and the "Technical Data" chapters 2.7 and 2.8). Make sure to establish a safe PE conductor connection. Plug the provided power cable into the rear of the appliance and connect it to the power supply.

Place the power cable so that

- it is easily accessible at all times and can be pulled off quickly, for example in case of interference or an emergency
- it does not represent a trip hazard
- it cannot come into contact with any hot parts

4.1.1 Filling and connecting the water tank (for constant climate chambers HPPeco only)

Water specifications

Only water with the following specifications may be used in Memmert appliances:

- demineralised/deionised
- Conductivity of 5 – 10 $\mu\text{S}/\text{cm}$
- pH value between 5 and 7
- chlorine-free

i

The use of ultrapure water or DI water with an electrical conductance level below 5 $\mu\text{S}/\text{cm}$ can damage silicone tubing and cause pitting on the stainless steel components installed. Unsuitable water also creates favourable conditions for limescale in the steam generators and steam pipes.

Connection

Fill the supplied water tank with water and use the enclosed tube to connect it to the "H₂O" connection on the rear of the chamber.

For appliances of size 410 or greater, the tank can be attached to the appliance with the included tank holder. To do this, fasten the tank holder to the rear panel using four screws. Then connect the water tank to the steam generator.

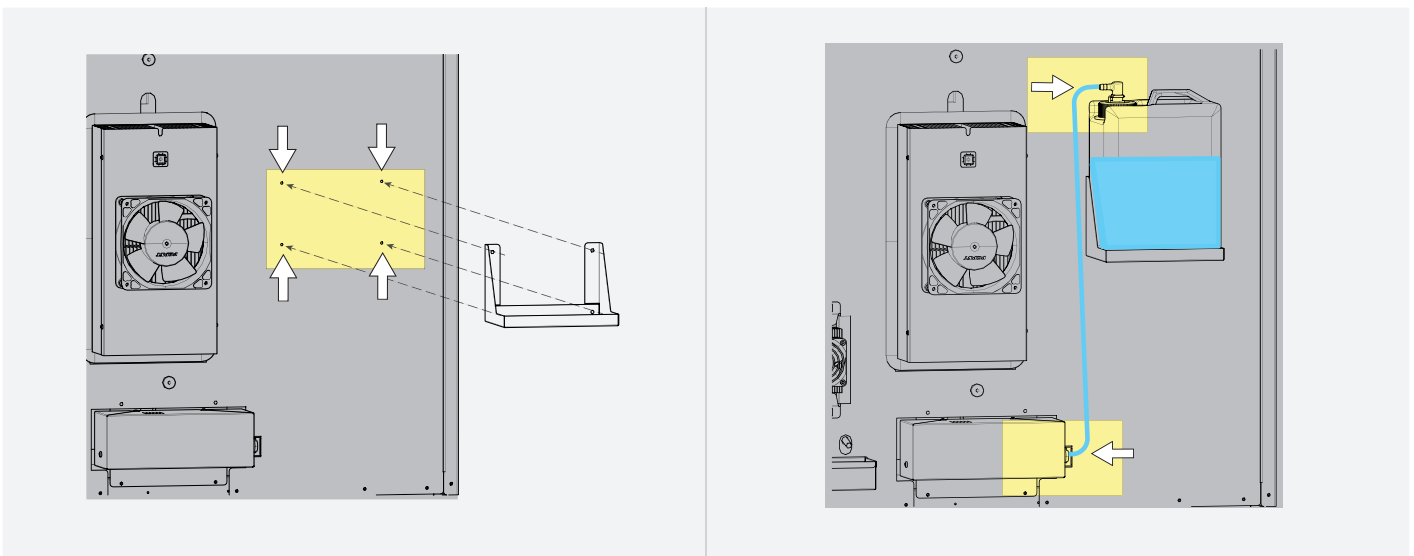

4.1.2 Hook drip pan

Holders for the drip pan are next to each Peltier dehumidifier. The drip pan is hooked into the holders from above

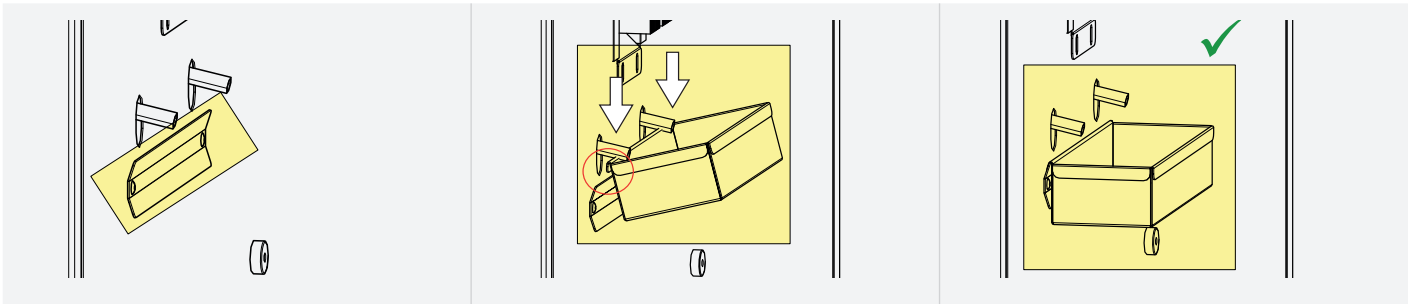

4.2 Switching on

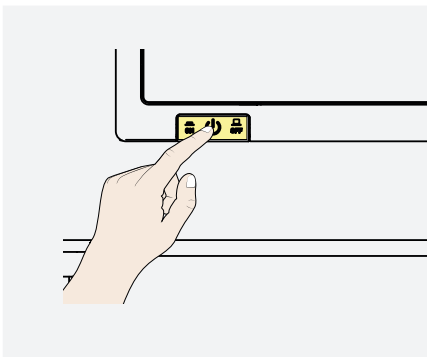

Press the main switch on the front of the appliance.

The start-up process is shown by three animated white dots . If the dots have another colour, an error has occurred (error messages see chapter 6). The appliance displays are in English by default when the appliance is switched on for the first time. How you can change the languages is described in chapter 7.2.

However, to get a basic overview of operating the appliance, you should read the following chapter first.

5. Operation and control

5.1 Operating personnel

The appliance may only be operated by persons who are of legal age and have been instructed accordingly. Personnel who are to be trained, instructed or who are undergoing general training may only work with the appliance under the continuous supervision of an experienced person.

Opening the door

⚠ WARNING

With appliances above a specific size, you could become accidentally locked inside, which could put you at risk of death. Do not climb into the appliance!

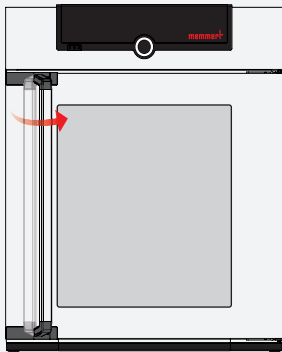

To open the door, pull the door handle sideways (to the left or to the right, depending on the door version, and open the door wide.

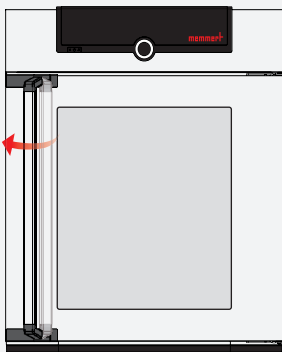

To close the appliance, push the door closed and push the door handle sideways.

Loading the appliance

⚠ WARNING



When loading the appliance with an unsuitable load, poisonous or explosive vapours or gases may be produced. This could cause the appliance to explode, and persons could be severely injured or poisoned. The appliance may only be loaded with materials which do not form any toxic or explosive vapours when heated up, and which cannot ignite. If there is any doubt as to the composition of materials, they must not be loaded into the appliance.

Check the chamber load for chemical compatibility with the materials of the appliance.

Insert the sliding steel grids or sliding shelves. The maximum number of grids / shelves and the load capacity are specified in the technical data overview in chapter 7.3.5. To achieve optimal temperature distribution, the type of slide-in unit used – steel grid or shelf – must be set in the menu under SETUP.

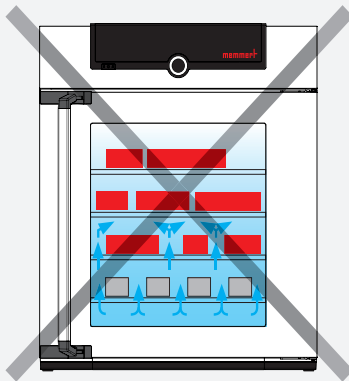

The chamber must not be loaded too tightly, so that proper air circulation in the interior is guaranteed.

Do not place any load on the floor, on the side walls or under the ceiling of the interior

In case of improper loading (not enough space between the items), the set temperature may be exceeded or it may take longer until it is reached.

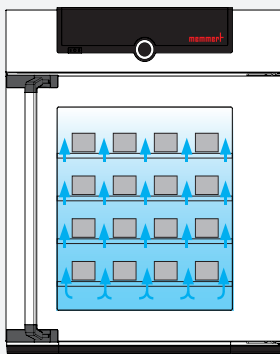

(see also the “correct loading” sticker on the appliance).

5.2 Operating the appliance

5.2.1 ControlCOCKPIT

In manual mode, the desired parameters are entered in the ControlCOCKPIT on the front of the appliance. You can also make basic settings here (menu mode). Additionally, warning messages are displayed, e.g. if the temperature is exceeded. In program mode, the parameters defined, the program description, the program segment currently active and program duration remaining are displayed.

HPPeco and IPPecoplus

<ol style="list-style-type: none"> 1. Activation key for temperature setpoint adjustment 2. Setpoint and actual temperature display 3. Menu key 4. Activation key digital backwards counter with target time setting 5. Main switch 6. Digital backwards counter with target time setting 	<ol style="list-style-type: none"> 7. Humidity control display 8. Humidity control activation key 9. Turn control for setpoint adjustment 10. Confirmation key 11. Interior lighting activation key (only for models with light module) 12. Interior lighting display (only for models with light module) 	<ol style="list-style-type: none"> 13. Appliance state and programme display 14. Activation key for the appliance state 15. Activation key for temperature monitoring 16. Monitoring display 17. Graphical representation 18. Activation key for graphical representation
---	---	---

5.2.2 Basic operation

In general, all settings are made according to the following pattern:

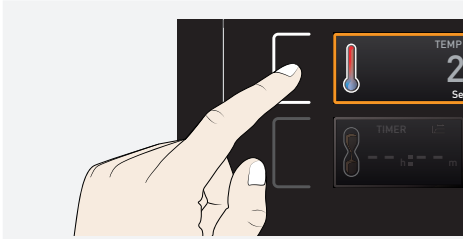

Activate the desired parameter (e.g. temperature). To do so, press the corresponding activation key on the left or right or the respective display. The activated display is lined in colour, the other displays are dimmed. The set value is highlighted in colour.

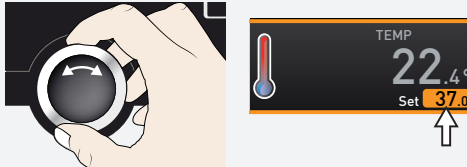

By turning the turn control to the left or right, adjust the set value (e.g. to 37.0 °C).

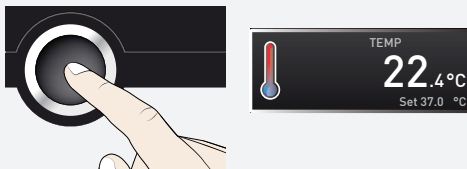

Save the set value by pressing the confirmation key. The display returns to normal and the appliance begins adjusting to the defined set value.

- Additional parameters can be set accordingly
- If no new values are entered or confirmed for approx. 30 seconds, the appliance automatically restores the former values

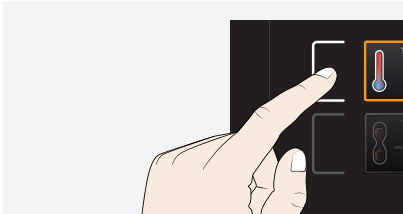

If you want to cancel the setting procedure, press the activation key on the left or right of the display that you want to exit. The appliance restores the former values. Only the settings that you have confirmed by pressing the confirmation key before cancelling the setting procedure are accepted.



5.3 Operating modes

The appliance can be operated in different modes:

Manual mode	The appliance runs in permanent operation at the values set on the ControlCOCKPIT. Operation in this mode is described in chapter 5.3.1.
Timer operation	Operation with digital backwards counter with target time setting, adjustable from 1 minute to 99 days (timer): The appliance will run at the values set until the set time has elapsed. Operation in this mode is described in chapter 5.3.2.
Program mode	The appliance automatically runs program sequences which have been defined using AtmoCONTROL software at a computer / laptop and then transferred to the appliance from a USB stick or via Ethernet. Operation in this mode is described in chapter 5.3.3.
Remote control mode	via remote control (chapter 7.3.8)

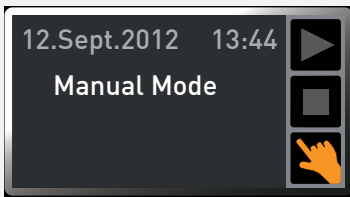
The status display shows which operating mode or operating state the appliance is currently in. The current operating state is highlighted in colour and indicated by the text display:



-  Appliance is in program mode
 -  program is stopped
 -  Appliance is in manual mode
- The example shows the appliance in manual mode, identified by the coloured hand symbol.

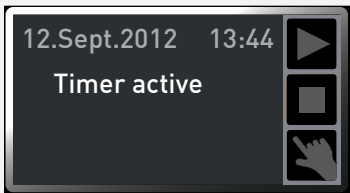

When the appliance is in timer mode, Timer active is displayed:

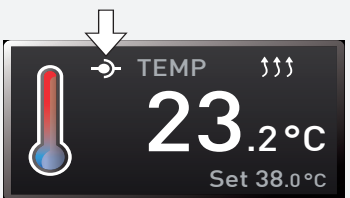

If the appliance is in remote control mode, the  symbol appears in the temperature display:

5.3.1 Manual mode

In this operating mode, the appliance runs in permanent operation at the values set on the ControlCOCKPIT.

Adjustment options

As described in chapter 5.2.2, you can set the following parameters after pressing the corresponding activation key (in any sequence):

Temperature

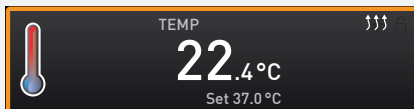

Adjustment range depends on appliance (see name plate chapter 2.7 and technical data chapter 2.8)

Heating operation is indicated by the ↑↑↑ symbol.

Cooling is indicated by the ❄️ symbol.

You can select °C or °F as the temperature unit displayed.



The minimum temperature that can be reached depends on the surrounding conditions. The devices can cool down to 20 °C below room temperature. For this purpose, the Peltier module needs sufficient ventilation

Humidity (for constant climate chambers HPPeco only)

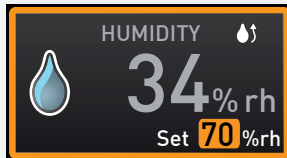

Adjustment range: 10 to 90 % rh

Humidification is indicated by the ⬆️ symbol.

Dehumidification is indicated by the ⬇️ symbol.



A high level of air humidity in the interior can only be achieved without condensation if the interior is thoroughly heated. For this reason, how fast the humidity is dynamically adjusted to approach the setpoint depends on the interior temperature.

Interior lighting (only for models with light module)

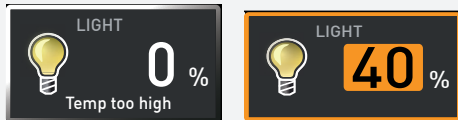

Adjustment range: 0 to 100 % in steps of 1%



The interior light is only active at temperatures of up to 40°. If this temperature is exceeded, the interior light switches off automatically. The light display will then show "Temp too high".

5.3.2 Operation with digital backwards counter with target time setting, adjustable from 1 minute to 99 days

In timer operation, you can adjust the time the appliance runs at the set values. The appliance has to be in manual operating mode for this.



Up to a duration of 23 hours 59 minutes, the time is displayed in hh:mm (hours:minutes) format. For 24 hours and more, the format dd:hh (days:hours) is used. The maximum duration adjustable is 99 days 00 hours.

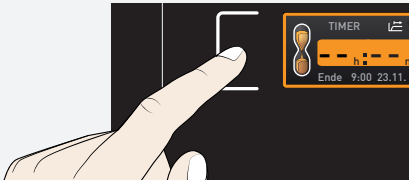

1. Press the activation key to the left of the timer display. The timer display is activated.



2. Turn the turn control until the desired duration is displayed – in this example 4 hours 30 minutes. The approximate end time is shown beneath, in a smaller font.

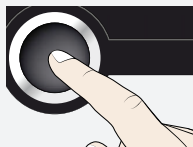

3. Press the confirmation key to confirm.

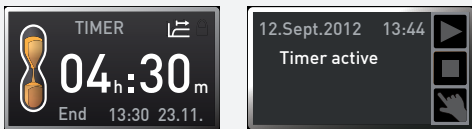

The display now shows the remaining time in a large font and the approximate end time in a smaller font beneath. The status display shows Timer active.

4. Now, as described under 5.2.2, set the individual values which you want the appliance to operate at. The set values can be changed at any time while the timer elapses. The changes are effective immediately.



In **Setup**, you can choose if the timer should run setpoint-dependent or not. This determines whether the timer should not start until a tolerance band around the set temperature is reached or if it should start right after activation. The symbol on the timer display indicates that the timer is set to setpoint-dependent.

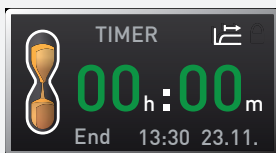

Once the timer has finished, the display shows 00h:00m. All functions (heating etc.) are switched off. In addition, an acoustic alarm sounds, which can be turned off by pressing the confirmation key.

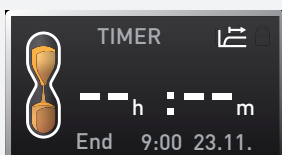

To- the timer, open the timer display by pressing the activation key again and then turning the turn control to reduce the timer setting until --:-- is displayed. Press the confirmation key to confirm.

5.3.3 Program mode

In this operating mode, programmes saved in the appliance can be started with different combinations of individual parameters (temperature, humidity, interior lighting) at staggered intervals, which the appliance then automatically processes in sequence. These programs are not created directly at the appliance but externally at a computer / laptop and using AtmoCONTROL software. Transfer to the appliance is possible using the provided USB storage medium or via Ethernet.



- A description of how to create and save programs can be found in the separate AtmoCONTROL software manual

Starting a programme

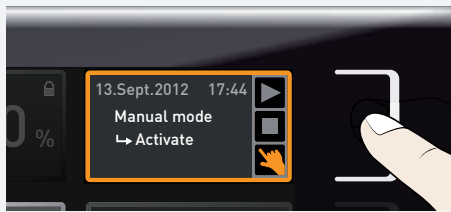

1. Press the activation key on the right of the status display. The current operating mode is highlighted automatically, in this example Manual Mode (👉).

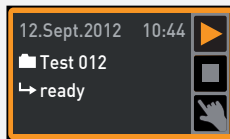

2. Turn the turn control until the ▶ start symbol is highlighted. The current program is displayed, in this example Test 012.



Only the program currently- in menu mode and shown in the display can be used. If you want to process another program, you need to activate it in menu mode first (description in chapter 7).

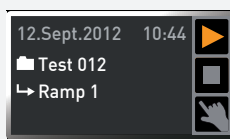
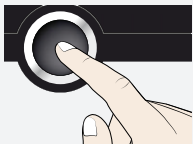

3. To start the program, press the confirmation key. The program is executed. The display shows:
 - the program description (in this example Test 012)
 - the programme segment description, in this example Ramp 1
 - the current run (in case of loops)



You cannot change any parameters (e.g. the temperature) at the appliance while a program is running. However, the displays ALARM and GRAPH can still be used.

Cancel program

You can cancel an active program at any time.



1. Press the activation key to the right of the status display. The status display is automatically highlighted.

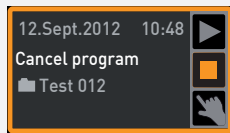

2. Turn the turn control until the ■ stop symbol is highlighted.

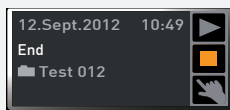
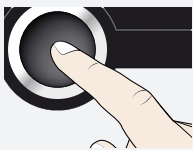

3. Press the confirmation key to confirm. The program is cancelled.



A cancelled program cannot be resumed at the point it was cancelled. It must be restarted from the beginning.

End of program

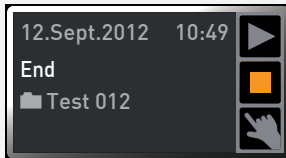

End is shown on the display to indicate that the program has finished normally.

You can now...

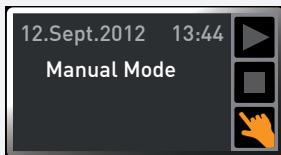

- restart the program as described
- select another program to run in menu mode and run it as described
- return to manual mode. To do so, reactivate it by pressing the activation key next to the status display, then turn the turn control until the hand symbol is highlighted in colour and press the confirmation key

5.4 Monitoring function

5.4.1 Temperature monitoring

The appliance is equipped with a multiple overtemperature protection in accordance with DIN 12 880. This serves to avoid damage to the chamber load and/or appliance in case of a malfunction:

- electronic temperature monitoring (TWW)
- automatic temperature monitor (ASF)

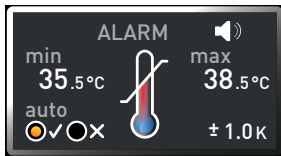

The monitoring temperature of the electronic temperature monitoring is measured via a separate PT100 temperature sensor in the chamber. Temperature monitoring settings are made via the ALARM display. The settings made apply to all operating modes.



If temperature monitoring has been triggered, this is indicated on the temperature display: the actual temperature is highlighted in red and a warning symbol is shown. The type of temperature monitoring triggered (TWW in this example) is shown beneath the temperature.

If the alarm sound has been activated in the menu mode (sounds, chapter 7.7, indicated by the speaker symbol in the alarm display), the alarm is additionally signalled by an intermittent acoustic signal, which can be turned off by pressing the confirmation key. Information on what to do in this case is provided in chapter 6.

Before reading how to adjust temperature monitoring (from chapter 5.4.4), please read the description of the individual monitoring functions here.

5.4.2 Electronic temperature monitoring (TWW)

The manually set monitoring temperature min and max of the overtemperature control is monitored by an adjustable over/undertemperature controller (TWW) of protection class 3.3 according to DIN 12 880. If the manually set monitoring temperature max is exceeded, the TWW takes over temperature control and begins to regulate the monitoring temperature

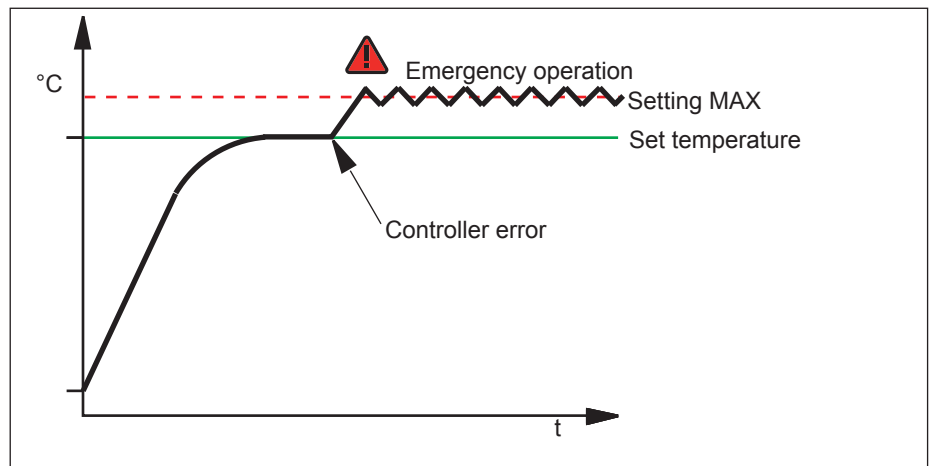

5.4.3 Automatic temperature monitor (ASF)

ASF is a monitoring device that automatically follows the set temperature setpoint with an adjustable tolerance band.

The ASF – if switched on – is automatically activated as soon as the actual temperature value reaches 50 % of the set tolerance band of the setpoint (in the example: 50 °C ± 1 K) for the first time (section A).

If the set tolerance band around the setpoint (50 °C ± 2 K) is left – e.g. if the door is opened during operation (section B of illustration) – the alarm will be set off. The ASF alarm is automatically terminated as soon as 50 % of the set tolerance band of the setpoint (in the example: 50 °C ± 1 K) are reached again (section C).

If the temperature setpoint is altered, the ASF is automatically disabled temporarily (in this example: The setpoint is changed from 50 °C to 25 °C, section D), until it reaches the tolerance range of the new temperature setpoint (section E).

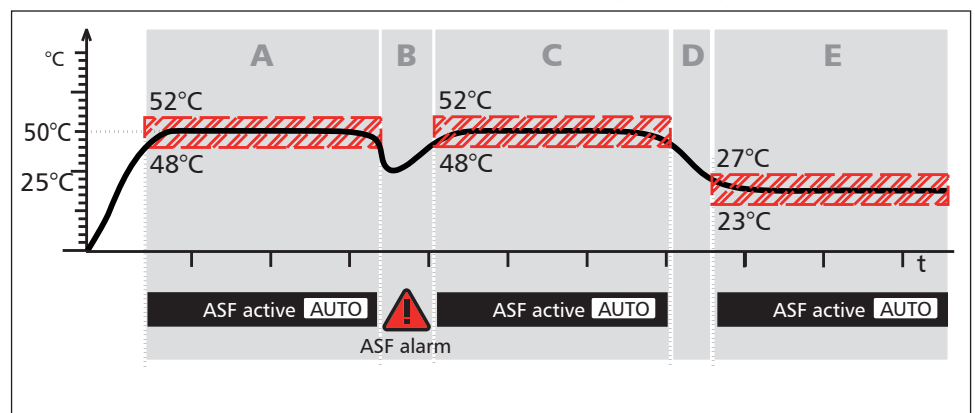

5.4.4 Adjusting temperature monitoring

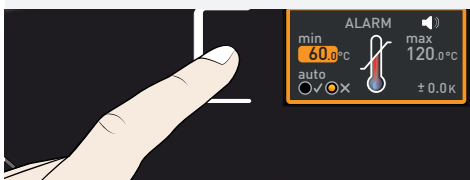

For IPPEcoplus cooled incubators:

- Press the activation key to the left of the ALARM display. The min setting (undertemperature protection) is automatically activated. Continue with item 1

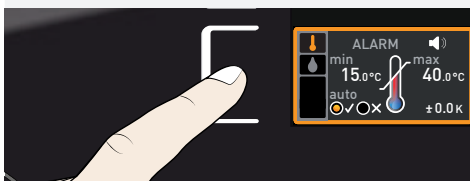

For constant climate chambers HPPeco:

- Press the activation key to the left of the ALARM display. The temperature monitoring setting is automatically activated (🔊).

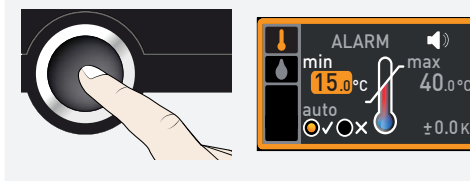

Save the selection by pressing the confirmation key. The min setting (undertemperature protection) is automatically activated.

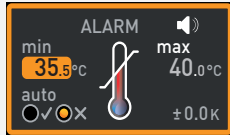

1. By turning the turn control, adjust the desired lower alarm limit value, in the example on the right 35.5 °C.



The lower alarm limit value cannot be set higher than the top one. If no undertemperature protection limit is required, set the lowest temperature.

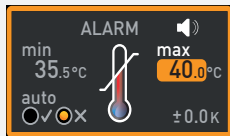
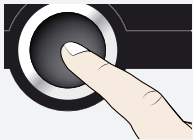

2. Press the confirmation key to confirm. The max display (overtemperature protection) is activated.

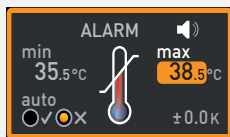

3. By turning the turn control, adjust the desired upper alarm limit value, in the example on the left 38.5 °C.



The monitoring temperature must be set sufficiently high above the maximum set temperature. We recommend 1 to 3 K.

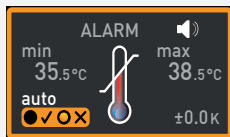
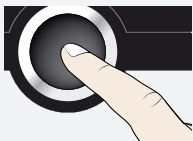

4. Accept the upper alarm limit value by pressing the confirmation key. The setting of the automatic temperature monitor (ASF) is automatically activated (auto).

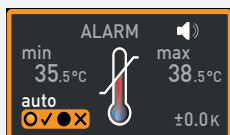

5. With the turn control, select ON (✓) or OFF (✗).

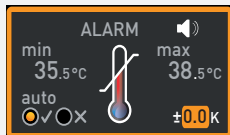
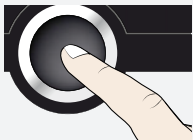

6. Press the confirmation key to confirm. The ASF tolerance band setting is activated.

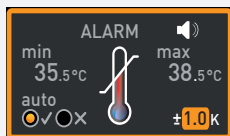

7. With the turn control, adjust the desired tolerance band, e.g. 2.0 K.



We recommend a tolerance band of 1 to 3 K.

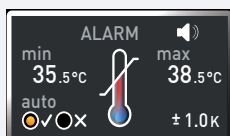
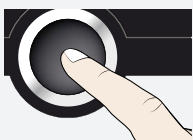

8. Press the confirmation key to confirm. Temperature monitoring is now active.

5.4.5 Humidity monitoring (for constant climate chambers HPPeco only)



If humidity monitoring was triggered, this is indicated by the humidity display: the actual humidity is highlighted in red and a warning symbol is shown (). If the alarm sound has been activated in the Menu mode (sounds, chapter 7.7, indicated by the speaker symbol), the alarm is additionally signalled by an intermittent acoustic signal. Information on what to do in this case is provided in chapter 6.

Adjusting humidity monitoring

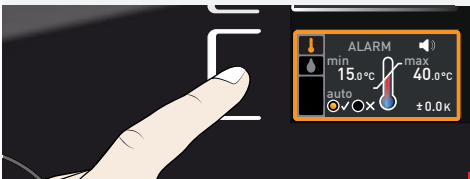

1. Press the activation key to the left of the ALARM display. The temperature monitoring setting is automatically activated.

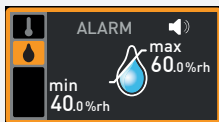
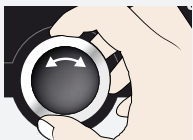

2. Turn the turn control until the humidity monitoring entry is highlighted.

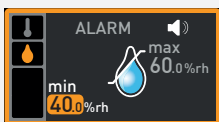
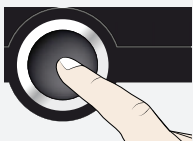

3. Accept the selection by pressing the confirmation key. The lower humidity alarm limit is automatically highlighted.

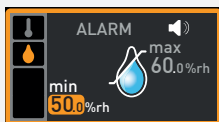
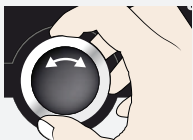

4. By turning the turn control, adjust the desired lower alarm limit, in the example on the left 50 % rh.

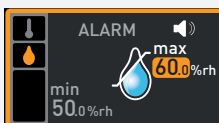
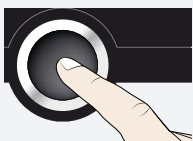

5. Accept the selection by pressing the confirmation key. The upper humidity alarm limit is automatically highlighted.

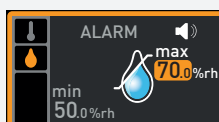

6. By turning the turn control, adjust the desired lower alarm limit, in the example on the left 70 % rh.

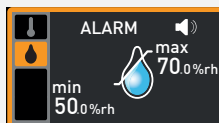
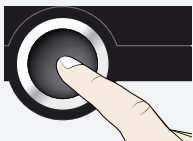

7. Accept the selection by pressing the confirmation key and exit the Alarm display by pressing the activation key on the side. Humidity monitoring is now active.

Graph

The GRAPH display provides an overview of the chronological sequence of the set values and the actual values as a curve.



To close the graphical representation, press the activation key you used to activate it again.

5.4.6 Temperature profile

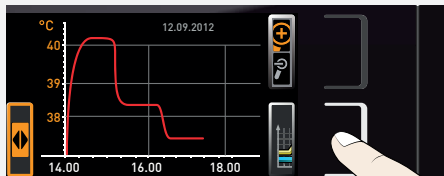

1. Press the activation key to the right of the GRAPH display. The display is enlarged and the temperature profile shown.

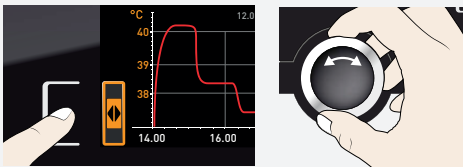

2. To change the time frame to be displayed: Press the activation key near the arrow symbols ◀▶. The time frame to be displayed can now be changed by turning the turn control.

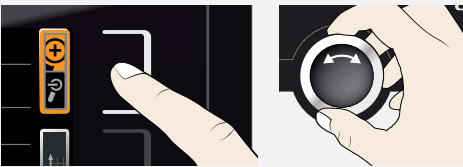

3. To zoom the graph in or out: Press the activation key next to the magnifying glass symbol. Select whether you want to zoom in or out (+/-) with the turn control and confirm your selection by pressing the confirmation key.

5.4.7 Humidity Humidity profile (for constant climate chambers HPPeco only)

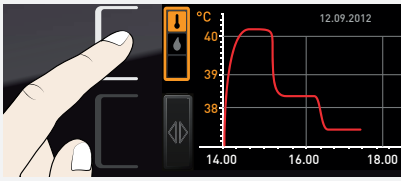

1. Activate graphic representation as described above and then press the activation key next to the parameter selection.

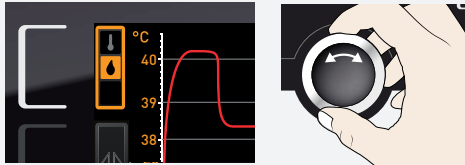

2. Set the humidity with the turn control.

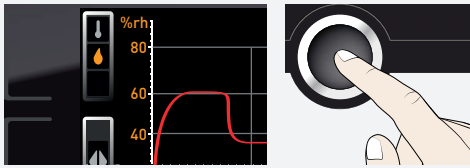

3. Press the confirmation key to confirm. The humidity profile is displayed. You can change the display range as described above, as well as extend or reduce it.

5.5 Ending operation

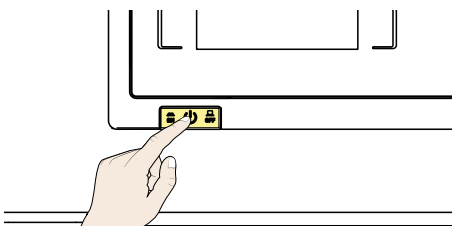

- Switch off active appliance functions (turn back the set values).
- Remove the chamber load
- For constant climate chambers HPPeco: Check the water tank and fill up if necessary (chapter 4.1.1)
- Switch off the appliance with the main switch

6. Malfunctions, warning and error messages

⚠ WARNING



Live components may be exposed once the covers have been removed. Touching these can lead to an electric shock. Malfunctions requiring work inside the appliance may only be rectified by electricians. Observe the separate service manual for this.

Do not try to rectify appliance errors yourself but contact the MEMMERT customer service department or an authorised service point.

In case of enquiries, please always specify the model and appliance number on the nameplate (see chapter 2.7).



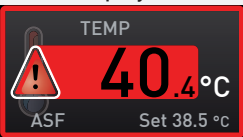
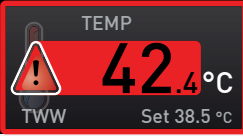

6.1 Warning message of the monitoring function

If the alarm sound has been activated in the menu mode (sound, chapter 7.7, indicated by the speaker symbol ), the alarm is additionally signalled by an intermittent acoustic signal. If the confirmation key is pressed, the acoustic alarm can be temporarily switched off until the next alarm event occurs.

6.1.1 Temperature monitoring



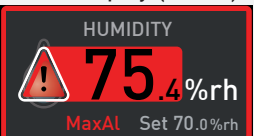

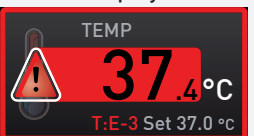

Description	Cause	Action
Temperature alarm and "ASF" are displayed 	Automatic temperature monitor (ASF) was triggered.	<ul style="list-style-type: none"> ■ Check if the door is closed. Closing the door ■ Extend the ASF tolerance band ■ If the alarm continues: Contact customer service
Temperature alarm and "TWW" are displayed 	The adjustable temperature controller (TWW) has assumed heating control.	<ul style="list-style-type: none"> ■ Increase the difference between the monitoring and setpoint temperature – by either increasing the max value of the temperature monitoring or decreasing the setpoint temperature. ■ If the alarm continues: Contact customer service

6.1.2 Humidity monitoring (for constant climate chambers HPPeco only)

Error description	Cause of error	Troubleshooting
Error display symbol  	Water tank empty	<ul style="list-style-type: none"> ■ Fill the water tank with water and press the confirmation key
Alarm display (MaxAl) 	Upper humidity limit exceeded	<ul style="list-style-type: none"> ■ Open the door for 30 sec. and wait to see if the appliance reliably adjusts to the setpoint ■ If the error occurs again, contact customer service.
Alarm display (MinAl) 	Humidity below lower limit	<ul style="list-style-type: none"> ■ Check if the door is closed ■ Check the water supply and the filling level of the water tank. If required, refill water ■ If the error occurs again, contact customer service.

6.1.3 Malfunctions, operating problems and appliance errors

Error description	Cause of error	Troubleshooting
Displays are dark	External power supply was interrupted	<ul style="list-style-type: none"> ■ Check the power supply
	Miniature fuse, appliance fuse or power module faulty	<ul style="list-style-type: none"> ■ Contact customer service
Displays cannot be activated	Appliance locked by USER ID	<ul style="list-style-type: none"> ■ Unlock with USER ID
	The appliance is in program, timer or remote control mode (mode "Write" or "Write + Alarm")	<ul style="list-style-type: none"> ■ Wait until the end of the program or timer mode or switch off the remote control
Displays suddenly look different	Appliance is in "wrong" mode	<ul style="list-style-type: none"> ■ Change to operating or menu mode by pressing the MENU key
Error message T:E-3 in the temperature display 	Temperature operating sensor is defective. The monitoring sensor takes over the measurement function.	<ul style="list-style-type: none"> ■ The appliance can temporarily be kept in service ■ Contact customer service as soon as possible

Error description	Cause of error	Troubleshooting
<p>Error message AI E-3 in the temperature display</p> 	<p>Temperature monitoring sensor is defective. The operating sensor takes over the measurement function.</p>	<ul style="list-style-type: none"> ■ The appliance can temporarily be kept in service ■ Contact customer service as soon as possible
<p>Error message E-3 in the temperature display</p> 	<p>Operating and monitoring sensor defective</p>	<ul style="list-style-type: none"> ■ Switch off appliance ■ Remove the chamber load ■ Contact customer service
<p>Error message E-6 in the humidity display</p> 	<p>Humidity sensor defective</p>	<ul style="list-style-type: none"> ■ No humidity control possible ■ Contact customer service
<p>When switching on the appliance, the start animation is displayed in another colour than white </p>	<p>Cyan : Not enough storage space on the SD card</p> <p>Red : The system files could not be loaded</p> <p>Orange : The fonts and images could not be loaded</p>	<ul style="list-style-type: none"> ■ Contact customer service

6.2 Power failure

In case of a power failure, the appliance operates as follows:

In manual mode

After power supply has been restored, operation is continued with the parameters set. The time and the duration of the power failure is documented in the log memory.

In timer or program mode

In case of an interruption of the power supply of less than 60 minutes, the current programme is continued from the point at which it was interrupted. For longer interruptions of the power supply, all appliance functions (heating, fan etc.) are switched off.

In remote control mode

The previous values are restored. If a program has been initiated via remote control, it is continued.

7. Menu mode

In menu mode, you can make basic settings, load programs and export protocols, as well as adjust appliance parameters.



Before changing menu settings, read the description of the respective functions on the following pages to avoid possible damage to the appliance and/or chamber load.

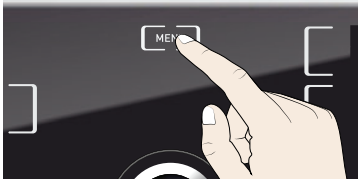

To enter menu mode, press the MENU key.



To exit the menu mode at any time, press the MENU key again. The appliance then returns to operating mode. Only changes accepted by pressing the confirmation key are saved.

7.1 Overview

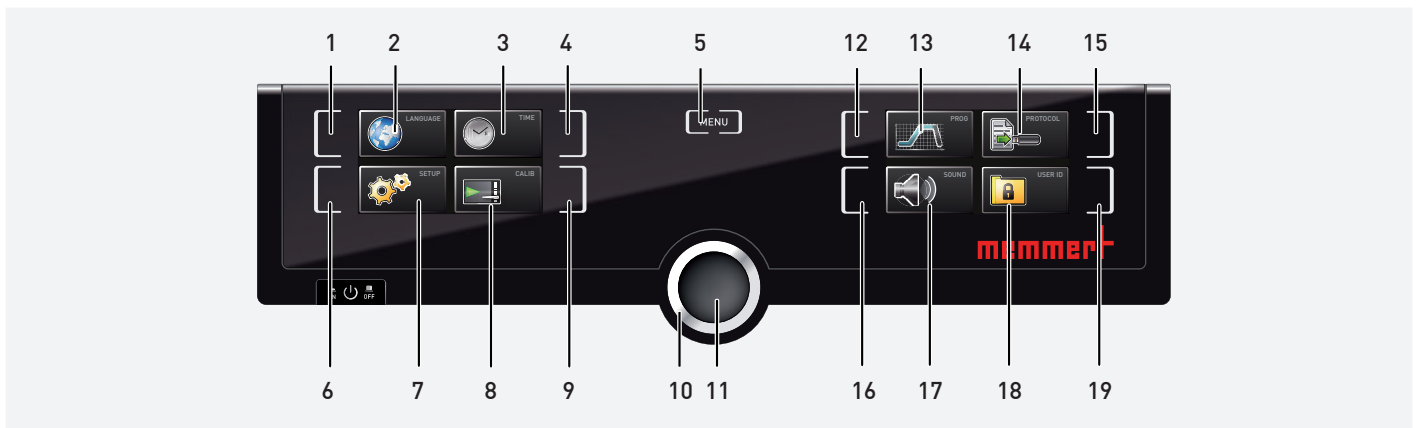

- | | | |
|--|---|---|
| 1. Language selection activation key | 7. Setup display (appliance settings) | 13. program selection display |
| 2. Language selection display | 8. Adjustment display | 14. Protocol display |
| 3. Date and time display | 9. Adjustment activation key | 15. Protocol activation key |
| 4. Date and time setting activation key | 10. Turn control for adjustment | 16. Acoustic signal adjustment activation key |
| 5. Exit menu mode and return to operating mode | 11. Confirmation key (accepts setting made with the turn control) | 17. Acoustic signal adjustment display |
| 6. Setup activation key (basic appliance settings) | 12. program selection activation key | 18. USER ID display |
| | | 19. USER ID display activation key |

7.2 Basic operation in menu mode using the example of language selection

In general, all settings in menu mode are done just like in operating mode: Activate the respective display, use the turn control for setting and press the confirmation key to accept the change. A more detailed description is provided in the following, using the example of language selection.

All other settings can be made accordingly. The settings possible are described in the following sections.



If no new values are entered or confirmed for approx. 30 seconds, the appliance automatically restores the former values

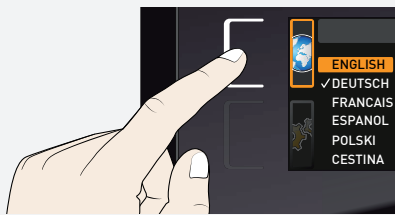

1. Activate the desired parameter (in this example the language). To do so, press the corresponding activation key on the left or right or the respective display. The activated display is enlarged.



- If you want to exit or cancel the settings, again press the activation key which you have used to activate the display. The appliance returns to the menu overview. Only the settings that you have confirmed by pressing the confirmation key before cancelling the setting procedure are accepted.

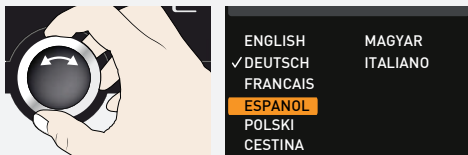

2. With the turn control, select the desired new setting, e.g. Español (Spanish).

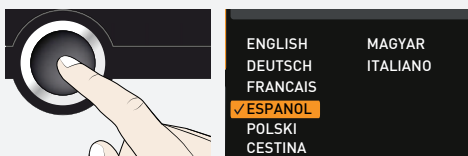

3. Save the setting by pressing the confirmation key.

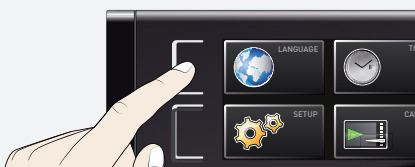

4. To return to the menu overview, press the activation key again.



You can now

- activate another menu function by pressing the corresponding activation key or
- return to operating mode by pressing the MENU key.

7.3 Setup

7.3.1 Overview

In the SETUP display, you can set the following parameters:

- the IP address and subnet mask of the appliance's Ethernet interface (for connection to a network)
- the unit on the temperature display (°C or °F, chapter 7.3.3)
- how the digital backwards counter with target time setting works (Timer Mode, chapter 5.3.2)
- The type of slide-in unit (grid or shelf, chapter 7.3.5)
- the heat output distribution (Balance, only for appliance sizes , chapter 7.3.6)
- Remote control (chapter 7.3.8)
- Gateway (see page 7.3.9)

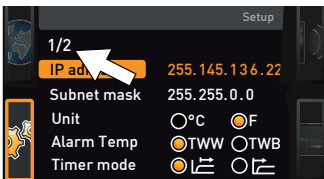

If the SETUP menu contains more entries than can be displayed, this is indicated by the display "1/2". This means that there is a second „page“ of entries.

To display the hidden entries, use the turn control to scroll beyond the lowest entry. The page display changes to "2/2".

7.3.2 IP address and subnet mask

If you want to operate one or more appliances in a network, each appliance must have its own unique IP address for identification. By default, each appliance is delivered with the IP address 192.168.100.100.

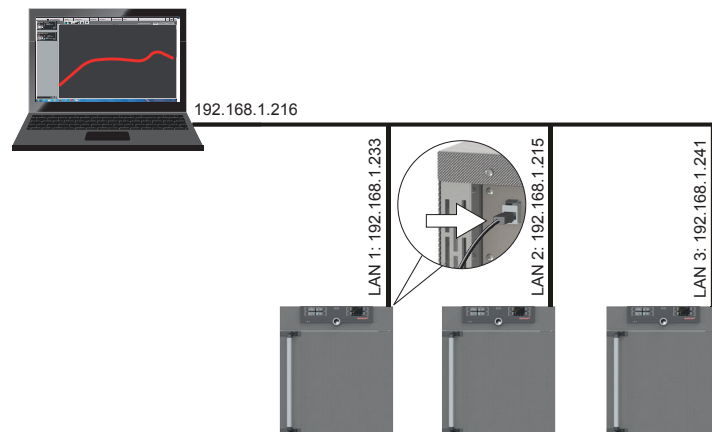

1. Activate the SETUP display. The entry IP address is automatically highlighted.

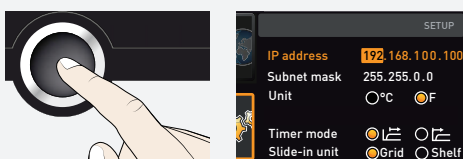

2. Accept the selection by pressing the confirmation key. The first three digits of the IP address are automatically selected.

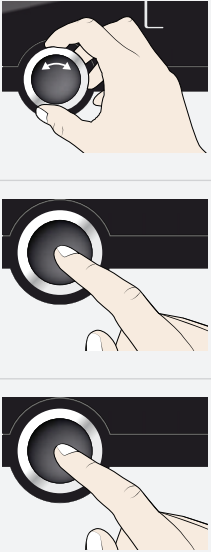

3. With the turn control, set the new number, e.g. 255.

4. Accept the selection by pressing the confirmation key. The next three digits of the IP address are automatically selected. Setting these is done according to the description above.

5. After setting the last three digits, accept the new IP address by pressing the confirmation key. The selection returns to the overview. The subnet mask is set accordingly.

7.3.3 Unit

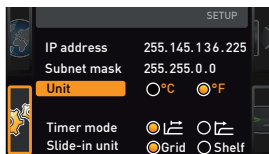

Here, you can choose whether the temperature is displayed in °C or °F.

7.3.4 Timer mode

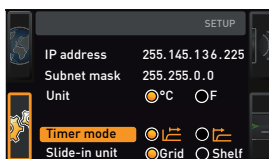

Here, you can choose whether the digital backwards counter with target time setting (timer, chapter 5.3.2) should run setpoint-dependent or not – this determines whether the timer should not start until a tolerance band of ± 3 K around the set temperature is reached (B) or whether it should start right after activation (A).

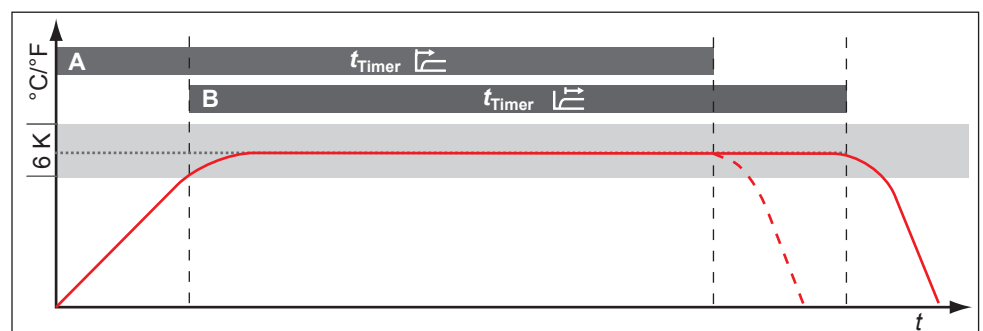

7.3.5 Slide-in unit type steel grid or shelf

Type of slide-in unit (steel grid or shelf)

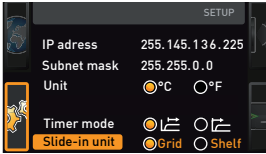

Here, you have to select the type of slide-in unit (steel grid or shelf) used. The selection Shelf enables you to adjust the control function to the different air flow characteristics in the interior when using optional sliding shelves instead of the steel grids that are provided as standard.

7.3.6 Balance

For appliances of the sizes 260, 410 and 750, application-specific correction of the heat output distribution (balance) between the upper and lower heating groups is possible.

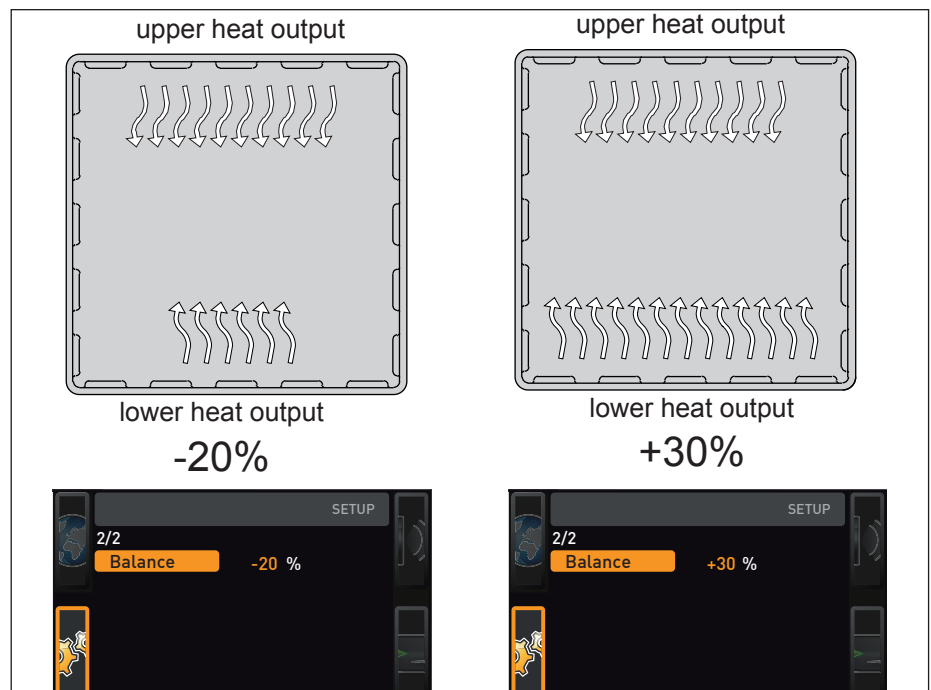

The adjustment range is from -50 % to +50 %.

Distribution of the heating/cooling power (example):

The -20 % (left) setting causes the lower Peltier elements to work at 20 % less power than the upper ones. The +30 % (right) setting causes the lower Peltier elements to work at 30 % more power than the upper ones. The 0 % setting restores the default distribution settings.

7.3.7 Dehumidification interval

The dehumidification peltier modules behind the rear panel precisely generate cold spots inside the chamber in order to remove humidity from the appliance in a controlled way.

If the device is dehumidifying for a long period of time in the lower end of the climate diagram, the water in the air will freeze at the dehumidification peltier modules. If solid ice should form at the rear panel around the dehumidification peltier modules, the dehumidification interval must be adjusted.

The dehumidification interval function allows the time spans at which the dehumidification peltier modules cool at maximum capacity to be adjusted individually. The preset value of 35 minutes is recommended for basic applications.

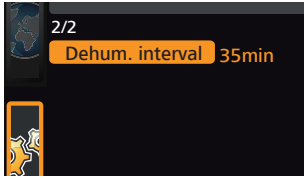

Adjustment range:

- Min. 15 minutes
- Max. 180 minutes

Example

1. Interval begins – dehumidification peltier modules cool at full power and generate coldest point (-12°C), depending on the set time interval.
2. Interval duration expired – dehumidification peltier modules are not operated for a short time, resulting in a local rise in temperature. The ice thaws and the melt water is channelled out.
3. Interval begins again

The ideal setting for the dehumidification interval is when there is hardly any ice formation on the rear panel and the setpoint humidity value is reached.

- The interval should be decreased if there is heavy ice formation on the rear panel
- If the setpoint value (humidity) is not reached, the interval should be increased
- For climate points in the low temperature range with low humidity, the interval should be extended

If you change the dehumidification interval, test whether this has a positive effect on low ice formation in the interior.

7.3.8 Remote control

In the setup entry remote control, you can set whether the appliance should be controlled via remote control and, if so, in which mode. These settings are available:

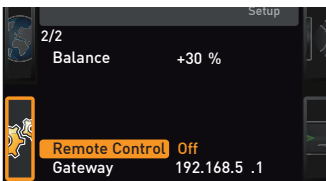

- Off
- Read Only
- Write + Read
- Write + Alarm

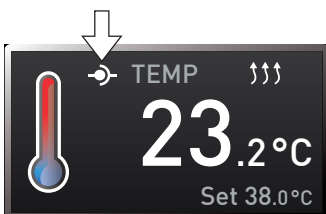

If the appliance is in remote control mode, the  symbol appears in the temperature display. In the settings Write + Read and Write + Alarm, the appliance cannot be controlled at the ControlCOCKPIT until the remote control has been switched off (setting Off) or set to Read.

In order to use the remote control function, programming skills and special libraries are required.

7.3.9 Gateway

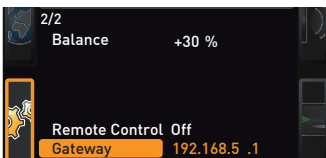

The setup entry gateway is used to connect two networks with different protocols. The gateway is set the same way as the IP address (chapter 7.3.2).

7.4 Date and Time

In the TIME display, you can set the date and time, time zone and daylight saving time. Changes can only be made in manual operating mode.



Always set the time zone (and daylight saving time yes/no) before setting the date and time. Avoid changing the set time after that since this can lead to gaps or overlapping when recording measured values. If you still need to change the time, you should not run a program immediately before or after doing so.

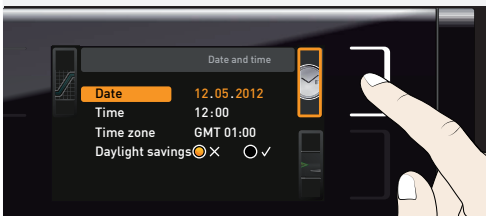

1. Activate the time setting. To do so, press the activation key on the right side of the TIME display. The display is enlarged and the first adjustment option (Date) automatically highlighted.

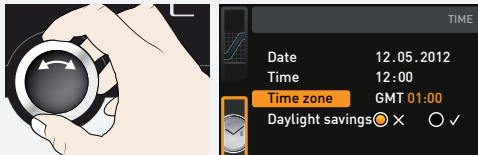

2. Turn the turn control until Time zone is highlighted.

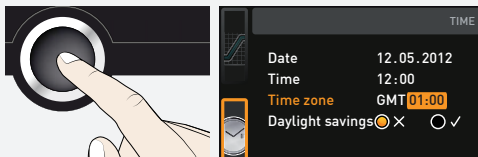

3. Accept the selection by pressing the confirmation key.

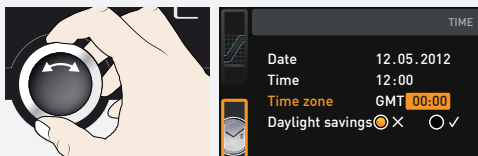

4. Use the turn control to adjust the time zone on the appliance location,
 - e.g. 00:00 for Great Britain
 - 01:00 for France, Spain or Germany

Accept the selection by pressing the confirmation key.

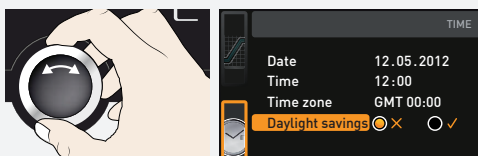

5. With the turn control, select the Daylight Savings entry.

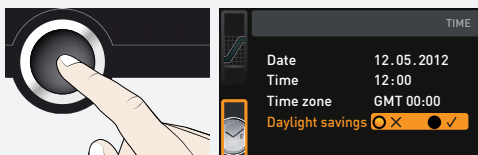

6. Accept the selection by pressing the confirmation key. The adjustment options are highlighted.

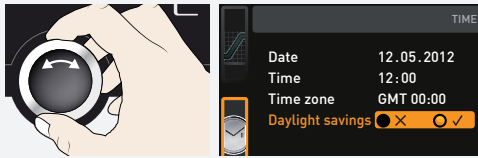

7. Set daylight savings to off (×) or on (✓) with the turn control – in this case on (✓). Save the setting by pressing the confirmation key.



Daylight saving time and standard time are not changed automatically. For this reason, please keep in mind to adjust them at the beginning of each period.

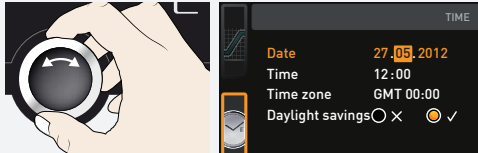

8. Now, set date (day, month year) and time (hours, minutes) in the same way. Accept each selection by pressing the confirmation key.

7.5 Calibration

To guarantee perfect control, we recommend calibrating the appliance once a year.

7.5.1 Temperature adjustment

The appliances are temperature calibrated and adjusted at the factory. In case readjustment should be necessary later on – for example due to influence of the chamber load – the appliance can be calibrated customer-specifically using three calibration temperatures of your choice:

- Cal1 Temperature calibration at low temperature
- Cal2 Temperature calibration at medium temperature
- Cal3 Temperature calibration at high temperature



For temperature adjustment, you will need a calibrated reference measuring device.

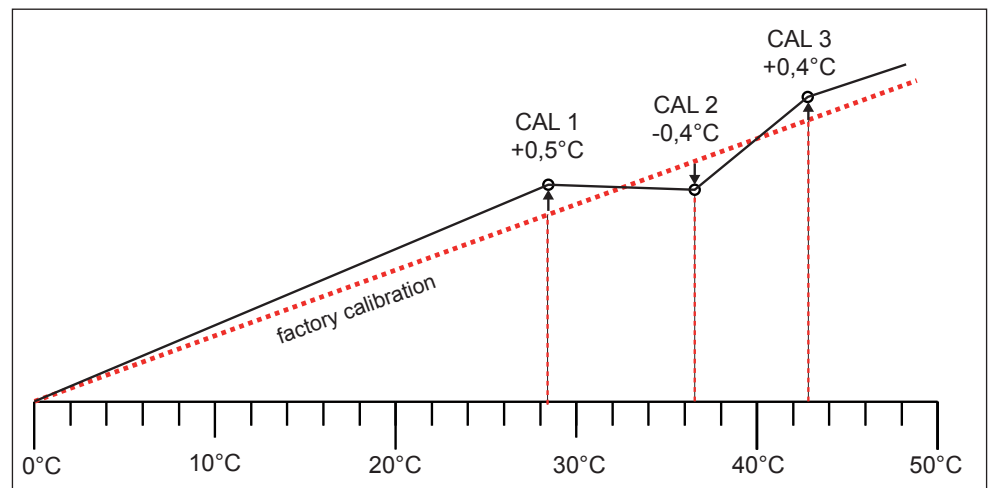

Example: Temperature deviation at 30°C is to be corrected



1. Press the activation key to the right of the CALIB display. The display is enlarged and the temperature adjustment option is automatically selected.

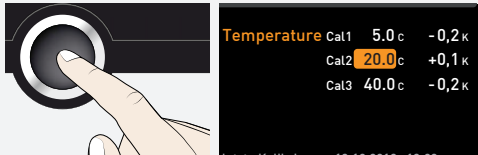

2. Press the confirmation key repeatedly, until the calibration temperature Cal2 is selected.

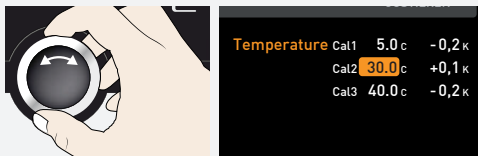

3. With the turn control, set the calibration temperature Cal2 to 30 °C.

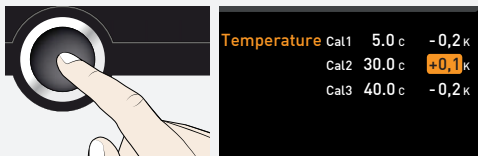

4. Save the setting by pressing the confirmation key. The corresponding calibration value is automatically highlighted.

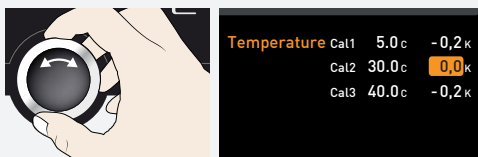

5. Set the calibration value to 0.0 K and accept the setting by pressing the confirmation key.

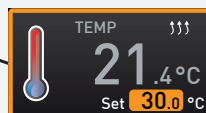
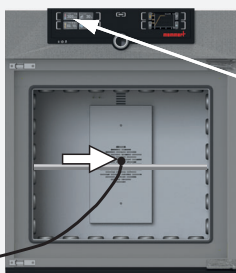

6. Position the sensor of a calibrated reference instrument centrally in the appliance's working chamber.
7. Close the door and, in manual mode, adjust the set temperature to 30 °C.

Example: Temperature deviation at 30°C is to be corrected

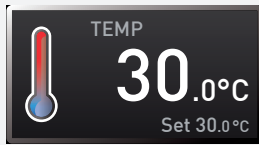
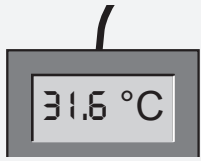

8. Wait until the appliance reaches the set temperature and displays 30 °C. The reference instrument displays for example 31.6 °C.

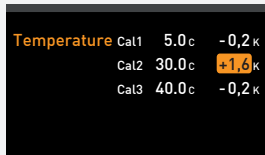

9. In the SETUP, adjust the calibration value Cal2 to +1.6 K (actual value measured minus setpoint temperature) and save the setting by pressing the confirmation key.

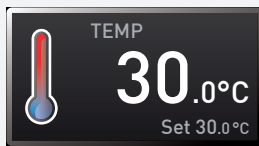
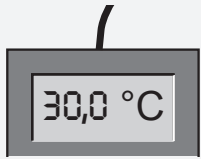

10. After the calibration procedure, the temperature measured by the reference instrument should now also be 30 °C.

With Cal1, a calibration temperature below Cal2 can be programmed accordingly, and with Cal3, a temperature above. The minimum difference between the Cal values is 10 K.

If all calibration values are set to 0.0 K, the factory calibration settings are restored.

7.5.2 Humidity Humidity profile (for constant climate chambers HPPeco only)

Humidity control of the constant climate chamber HPPeco can be adjusted according to customer requirements by means of three freely selectable balance points. For each selected balance point a positive or negative compensation correction value can be set between -10 % and +10 %.

i

For humidity adjustment, you will need a calibrated reference measuring device.

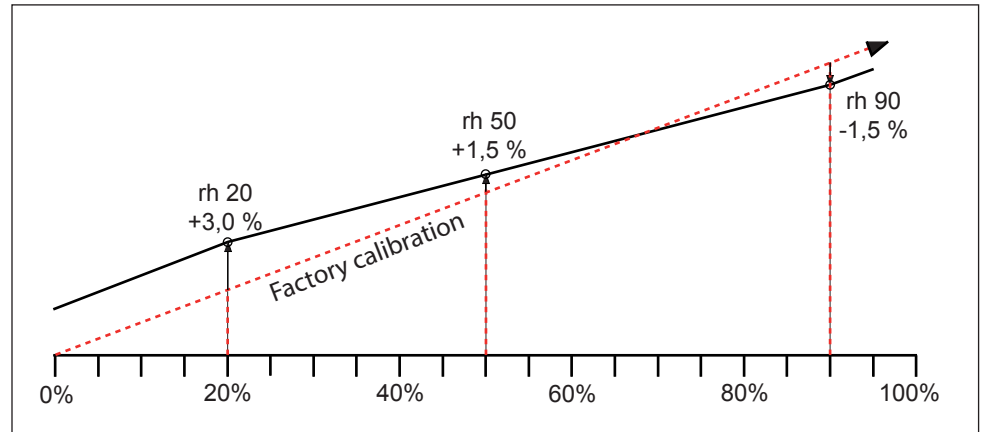

Example: Humidity deviation at 60 % should be corrected



1. Press the activation key to the right of the CALIB display. The display is enlarged and the temperature adjustment option is automatically selected.

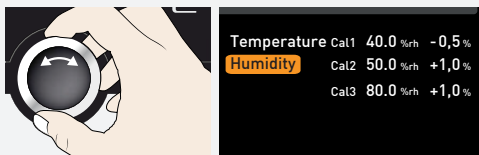

2. Turn the turn control until Humidity is highlighted.

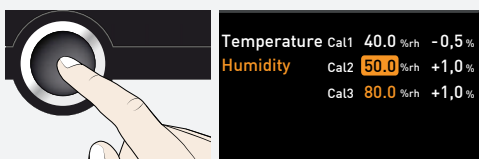

3. Press the confirmation key repeatedly, until the calibration point Cal2 is selected.

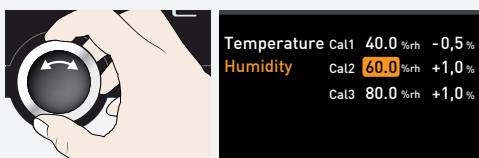

4. With the turn control, set the calibration point Cal2 to 60 % rh.

Example: Humidity deviation at 60 % should be corrected

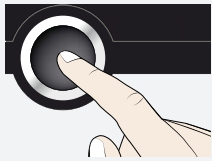

Temperature Cal1 40.0 %rh -0,5%
 Humidity Cal2 60.0 %rh **+1,0%**
 Cal3 80.0 %rh +1,0%

5. Save the setting by pressing the confirmation key. The corresponding calibration value is automatically highlighted.



Temperature Cal1 40.0 %rh -0,5%
 Humidity Cal2 60.0 %rh **0,0%**
 Cal3 80.0 %rh +1,0%

6. Set the calibration value to 0.0 % and accept the setting by pressing the confirmation key.

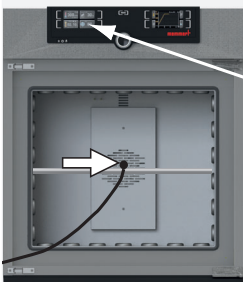

HUMIDITY 
29.5%rh
 Set 60.0%rh

7. Position the sensor of the calibrated reference instrument centrally in the working chamber of the appliance.
 8. Close the door and, in manual mode, adjust the set humidity to 60 % rh.

58.5 %rh

9. Wait until the appliance reaches the set humidity and displays 60 % rh. The reference instrument displays for example 58.5 % rh.



Temperature Cal1 40.0 %rh -0,5%
 Humidity Cal2 60.0 %rh **-1,5%**
 Cal3 80.0 %rh +1,0%

10. In the SETUP, adjust the compensation correction value Cal2 to -1.5% (actual value measured minus setpoint temperature) and save the setting by pressing the confirmation key.

60.0 %rh

HUMIDITY 
60.0%rh
 Set 60.0%rh

11. After the calibration-, the humidity measured by the reference instrument should now also be 60 % rh.

7.6 Program

In the Program display, programmes created using the AtmoCONTROL software can be transferred to the appliance and saved on a USB storage medium. Here, you can also select the programme provided for use (chapter 5.3.3) and delete programmes.

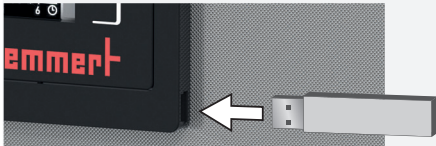

i To load a programme from a USB storage medium: Connect the USB storage medium with the saved programme(s) to the interface on the right side of the ControlCOCKPIT.

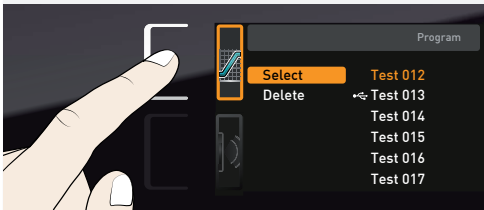

1. Activate the programme display. To do so, press the activation key on the left side of the Prog display. The display is enlarged and the entry Select automatically highlighted. The programs available for activation are shown on the right. The program currently available for use – in this example Test 012 – is highlighted in orange.

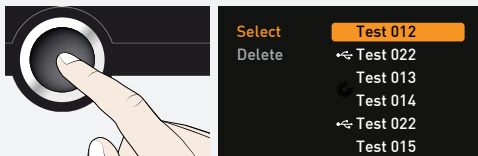

2. Access the Select function by pressing the confirmation key. All programs available are displayed, including the ones saved on the USB storage medium (identified by the USB symbol). The program currently available for use is highlighted in orange.

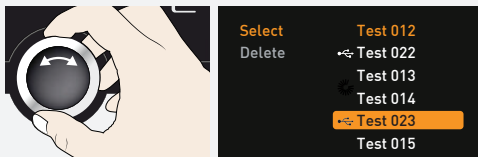

3. With the turn control, select the program you want to make available for use.

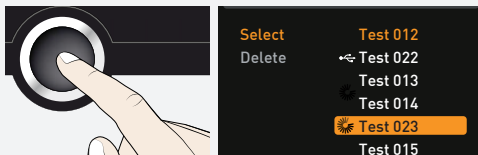

4. Accept the selection by pressing the confirmation key. The program is now loaded, which is indicated by the transfer symbol.

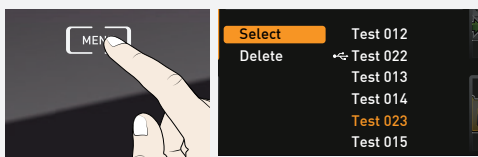

5. As soon as the program is ready, the selection returns to Select. To start the programme: As described in the chapter 5.3.3, return to operating mode by pressing the MENU key.

You can now remove the USB storage medium.

To delete a program, select Delete with the turn control and select the program to be deleted the same way you can select a program for activation.

7.7 Sound

In the Sound display, it can be define whether or not the appliance should emit acoustic signals and, if yes, on which events:

- on the press of a key
- at the end of a program
- On alarm
- if the door is open



1. Activate the acoustic signal adjustment. To do so, press the activation key on the left side of the Sound display. The display is enlarged. The first category (in this case Keysound) is automatically highlighted. On the right, the current settings are shown on.

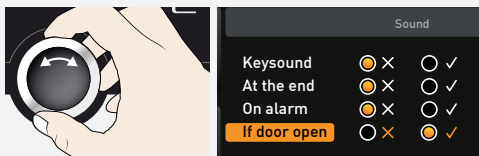

- i** If you want to edit another list entry: Turn the turn control until the respective entry – e.g. if door open (special configuration) – is highlighted in colour.

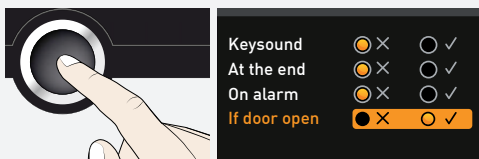

2. Save the selection by pressing the confirmation key. The adjustment options are automatically highlighted.

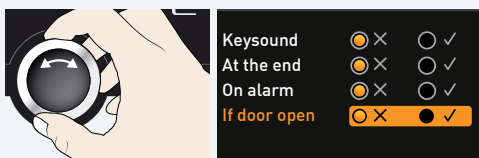

3. With the turn control, select the desired setting – in this example OFF (x).

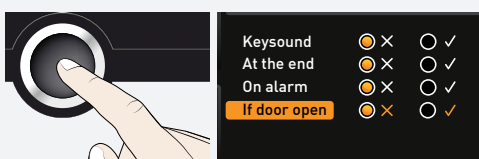

4. Save the setting by pressing the confirmation key.



If an acoustic alarm sounds, it can be turned off by pressing the confirmation key.

7.8 Protocol

The appliance continually logs all relevant measured values, settings and error messages at 1-minute intervals. The internal log memory is of the continuous memory type. The logging function cannot be switched off and is always active. The measured data are stored in the appliance, safe from manipulation. If the power supply is interrupted, the time of the power failure and voltage recovery are stored in the appliance.

You can read out the log data for different periods to a USB storage medium via the USB port or via Ethernet and then import them to the AtmoCONTROL program for graphical representation, printing out or storage.

The log memory of the appliance is not modified or deleted by reading it out.

i

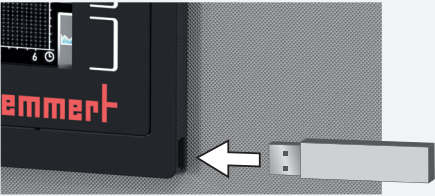

1. Connect the USB storage medium to the USB port on the right of the ControlCOCKPIT.

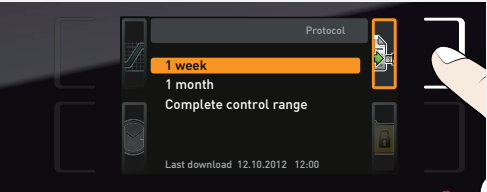

2. Activate the protocol. To do so, press the activation key on the right side of the PROTOCOL display. The display is enlarged and the period This month automatically highlighted. To select another logging period, use the turn control.

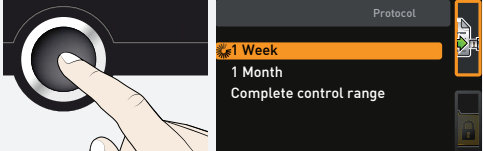

3. Save your selection by pressing the confirmation key. The transfer starts and a status symbol indicates the progress.

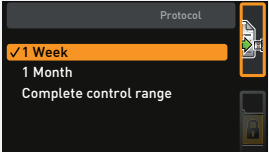

4. As soon as the transfer is complete, a check mark appears in front of the period selected. You can now remove the USB storage medium.



For a description of how to import and process protocol data in AtmoCONTROL or read it out via Ethernet, please refer to the separate AtmoCONTROL manual.

7.9 USER ID

7.9.1 Description

With the USER ID function, you can lock the settings of individual (e.g. temperature) or all parameters, so that they cannot be changed at the appliance by accident or unauthorised persons. You can also lock setting options in menu mode (e.g. adjustment or date and time settings) this way.

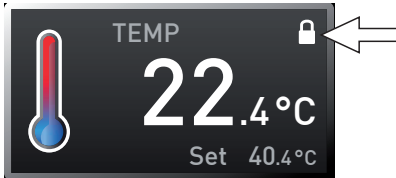

i If adjustment options are locked, this is indicated by the lock symbol in the respective display.

USER ID data is entered in the AtmoCONTROL software and saved on the USB storage medium. The USB storage medium is thus acting as a key: Parameters can only be locked or unlocked if it is connected.

i A description of how to create a USER ID in AtmoCONTROL is provided in the separate AtmoCONTROL manual.

7.9.2 USER ID activation and deactivation

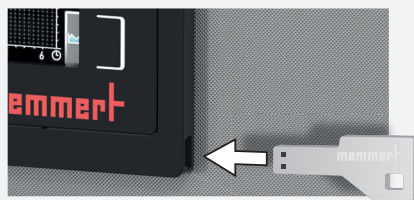

1. Connect the USB storage medium with the USER ID data to the USB port on the right of the ControlCOCKPIT.

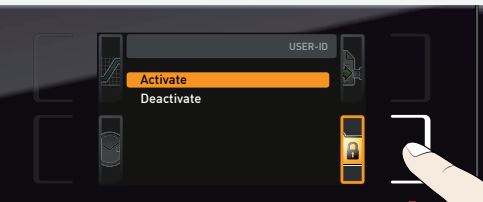

2. Activate the USER ID. To do so, press the activation key on the right side of the USER ID display. The display is enlarged and the entry Activate automatically highlighted.

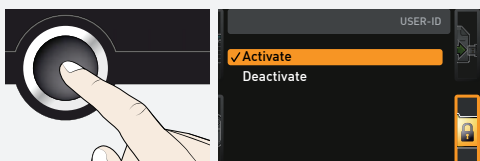

3. Confirm the activation by pressing the confirmation key. The new USER ID data are transferred from the USB storage medium and activated. As soon as activation is complete, a check mark appears in front of the corresponding entry.

4. Remove the USB storage medium. Locked parameters are indicated by the lock symbol on the respective display. To unlock the appliance, connect the USB storage medium, activate the USER ID display and select the entry Deactivate.

8. Maintenance and Servicing

⚠ WARNING



Risk of electric shock.
Disconnect the mains plug before any cleaning or maintenance work.

⚠ WARNING



With appliances above a specific size, you could become accidentally locked inside, which could put you at risk of death. Do not climb into the appliance!

⚠ CAUTION



Danger of cuts due to sharp edges.
Always wear gloves when working in the interior of the chamber.

8.1 Cleaning

8.1.1 Interior and metal surfaces

Regular cleaning of the easy-to-clean interior prevents build up of material remains that could impair the appearance and functionality of the stainless steel chamber over time.

The metal surfaces of the appliance can be cleaned with normal stainless steel cleaning agents. Make sure that no rusty objects come into contact with the interior or with the stainless steel housing. Rust deposits can lead to an infection of the stainless steel. If rust spots should appear on the surface of the interior due to impurities, the affected area must be immediately cleaned and polished.

8.1.2 Plastic parts

Do not clean the ControlCOCKPIT and other plastic parts of the appliance with caustic or solvent-based cleaning agents.

8.1.3 Glass surfaces

Glass surfaces can be cleaned with a commercially available glass cleaner.

8.1.4 Peltier cooling modules

In order to guarantee perfect function and long lifetime of the Peltier cooling modules, it is absolutely essential that you remove dust deposits from the heat sink on the rear of the appliance (with a vacuum cleaner, paintbrush or bottle brush, depending on the amount).

8.2 Regular maintenance

Once a year, grease the moving parts of the doors (hinges and lock) with thin silicone grease and check that the hinge screws are not loose.

To guarantee perfect control, we recommend calibrating (chapter 7.5) the appliance once a year.

8.3 Repairs and service

WARNING



Live components may be exposed once the covers have been removed. Touching these can lead to an electric shock. Disconnect the mains plug before removing any covers. Any work inside the appliance may only be performed by qualified electricians.



Repairs and service work are described in a separate service manual.

9. Storage and disposal

9.1 Storage

The appliance may only be stored under the following conditions:

- in a dry and enclosed, dust-free room
- frost-free
- disconnected from the power supply

Before storage, remove water tube and empty the water tank (chapter 4.1.1).

9.2 Disposal

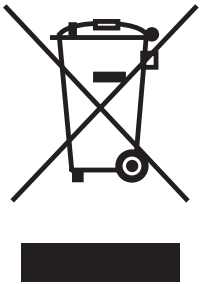

This product is subject to Directive 2012/19/EC on Waste Electrical and Electronic Equipment (WEEE) of the European Parliament and of the Council of Ministers. This appliance was placed on the market after 13 August 2005 in countries which have already integrated this Directive into their national laws. It may not be disposed of in normal household waste. For disposal, please contact your dealer or the manufacturer. Any appliances that are infected, infectious or contaminated with materials hazardous to health are excluded from return. Please also observe all other regulations applicable in this context.

Before disposing of the appliance, please render the door locking mechanism unusable, for example to prevent playing children from being locked inside the appliance.

There is a lithium battery in the ControlCOCKPIT of the appliance. Remove it and dispose of it in accordance with the regulations in your country.

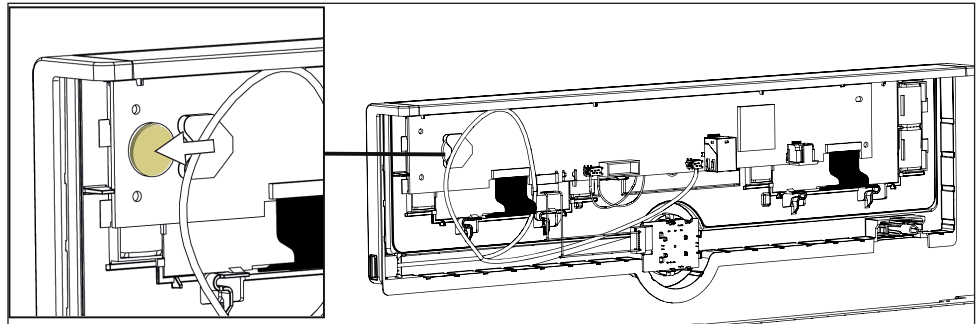

- Note for Germany:
The appliance may not be left at public or communal recycling or collection points

Constant climate chamber HPPeco
Peltier cooled incubator IPPeco plus

Operating manual
D49025
Last updated 03/2021
English