



LABCONCO CORPORATION
8811 Prospect Avenue
Kansas City, MO 64132
(800) 821-5525, (816) 333-8811
(816) 363-0130 fax
labconco@labconco.com

User's Manual

FreeZone[®] Triad[™] Freeze Dryers

Models

7940010** Series

To receive important product updates,
complete your product registration card
online at register.labconco.com

Please read the User's Manual before operating the equipment.

Copyright © 2017 Labconco Corporation. The information contained in this manual and the accompanying products are copyrighted and all rights reserved by Labconco Corporation. Labconco Corporation reserves the right to make periodic design changes without obligation to notify any person or entity of such change.

Warranty

Labconco Corporation provides a warranty to the original buyer for the repair or replacement of parts and reasonable labor as a result of normal and proper use of the equipment with compatible chemicals. Broken glassware and maintenance items, such as filters, gaskets, light bulbs, finishes and lubrication are not warranted. Excluded from warranty are products with improper installation, erratic electrical or utility supply, unauthorized repair and products used with incompatible chemicals.

The warranty for FreeZone® Freeze Dry Systems will expire one year from date of installation or two years from date of shipment from Labconco, whichever is sooner. Warranty is non-transferable and only applies to the owner (organization) of record.

Buyer is exclusively responsible for the set-up, installation, verification, decontamination or calibration of equipment. This limited warranty covers parts and labor, but not transportation and insurance charges. If the failure is determined to be covered under this warranty, the dealer or Labconco Corporation will authorize repair or replacement of all defective parts to restore the unit to operation. Repairs may be completed by 3rd party service agents approved by Labconco Corporation. Labconco Corporation reserves the rights to limit this warranty based on a service agent's travel, working hours, the site's entry restrictions and unobstructed access to serviceable components of the product.

Under no circumstances shall Labconco Corporation be liable for indirect, consequential, or special damages of any kind. This warranty is exclusive and in lieu of all other warranties whether oral, or implied.

Returned or Damaged Goods

Do not return goods without the prior authorization from Labconco. Unauthorized returns will not be accepted. If your shipment was damaged in transit, you must file a claim directly with the freight carrier. Labconco Corporation and its dealers are not responsible for shipping damages.

The United States Interstate Commerce Commission rules require that claims be filed with the delivery carrier within fifteen (15) days of delivery.

Limitation of Liability

The disposal and/or emission of substances used in connection with this equipment may be governed by various federal, state, or local regulations. All users of this equipment are required to become familiar with any regulations that apply in the user's area concerning the dumping of waste materials in or upon water, land, or air and to comply with such regulations. Labconco Corporation is held harmless with respect to user's compliance with such regulations.

Contacting Labconco Corporation

If you have questions that are not addressed in this manual, or if you need technical assistance, contact Labconco's Customer Service Department or Labconco's Product Service Department at 1-800-821-5525 or 1-816-333-8811, between the hours of 7:30 a.m. and 5:30 p.m., Central Standard Time.

TABLE OF CONTENTS

CHAPTER 1: INTRODUCTION	1
Intended Use	1
Typographical Conventions	1
Safety Information	2
Freeze Dry Process	3
Freeze Dry Rates	3
Freeze Dry Capacity	4
Samples Containing Volatile Substances	5
About This Manual	5
CHAPTER 2: PREREQUISITES	6
Electrical Requirements	6
Location Requirements	7
Vacuum Pump Requirements	7
CHAPTER 3: GETTING STARTED	8
Unpacking Your Freeze Dryer	8
Freeze Dryer Components	9
Setting Up Your Freeze Dryer	9
Component Identification	10
Vacuum Pump Connection	11
Electrical Connection	12
Chemical Resistance of Freeze Dryer Components	12
Solvent Safety Precautions	14
CHAPTER 4: LYO-WORKS™ OPERATING SYSTEM	15
Control Panel	16
Initial Power Up	16
Touch Screen Operation	17
Home screen	17
Main Menu Icons	17
Moving between Menu Screens	17
Function Indicator Bar	17
System Parameters Display	18
Operation Buttons (Program, Manual, Vacuum, Defrost)	19
Programs screen	20
Data Logging screen	22

Settings screen	23
Language	23
Time & Date	23
Units	24
Security	24
Alerts	25
Configure Email Settings	26
Maintenance	27
Vacuum Pump Settings	27
Refrigeration System Settings	27
Freeze Dryer Line Voltage Offset	27
Vacuum Pump Protection	27
Calibration	28
Display	29
Network	30
Data Logs	30
Sensors screen	30
End Point Detection screen	31
Help screen	32
About	32
Diagnostics	32
Resources	33
About	33
CHAPTER 5: USING YOUR FREEZE DRYER	34
Operation Checklist	34
Vacuum Pump Ballast Setting	34
Sample Freezing	34
Shelf Loading	35
Setting the Operating Vacuum Level	35
Freeze Drying Inside the Chamber	37
Manual Mode with Pre-Frozen Samples	37
Manual Mode with Unfrozen Samples	38
Program Mode with Pre-Frozen Samples	38
Program Mode with Unfrozen Samples	39
Stopping the Freeze Dry Cycle	39
Freeze Drying Using Sample Valves (In-Flask Mode)	40
Stoppering Vials	41
Vacuum Break/Backfilling	41
Defrosting	42
Alerts	42
Copy (Export) a Data Log File	44
Download a Data Log File via Ethernet	44
Copy a Program	45
CHAPTER 6: MAINTAINING YOUR FREEZE DRYER	46
Service Safety Precautions	46
Routine Maintenance Schedule	46

CHAPTER 7: TROUBLESHOOTING	48
Vacuum Pump	48
Gaskets, Tubing, Connections, Sample Valves	49
System Components & Collector Chamber Isolation	51
Refrigeration Module Operation	53
APPENDIX A: FREEZE DRYER COMPONENTS	54
APPENDIX B: FREEZE DRYER DIMENSIONS	56
APPENDIX C: FREEZE DRYER SPECIFICATIONS	57
Electrical Specifications	57
Environmental Conditions	58
APPENDIX D: FREEZE DRYER ACCESSORIES	59

CHAPTER 1

INTRODUCTION

Congratulations on your purchase of a Labconco FreeZone® Triad™ Freeze Dry System, which is designed for laboratory lyophilization procedures. The refrigerant used in the refrigeration system is HCFC-free so it will not endanger the environment. The unit is easy to install and maintain. Proper care and maintenance of this product will result in many years of dependable service.

Intended Use

The Labconco Freeze Dryers described in this manual are intended for laboratory use to facilitate the lyophilization process.

Typographical Conventions

Recognizing the following typographical conventions will help you understand and use this manual:

- Book, chapter, and section titles are shown in italic type (e.g., *Chapter 3: Getting Started*).
- Steps required to perform a task are presented in a numbered format.
- Comments located in the margins provide suggestions, reminders, and references.
- Critical information is presented in boldface type in paragraphs that are preceded by the exclamation icon. Failure to comply with the information following an exclamation icon may result in injury to the user or permanent damage to your Freeze Dryer.
- Important information is presented in capitalized type in paragraphs that are preceded by the pointer icon. It is imperative that the information contained in these paragraphs be thoroughly read and understood by the user.

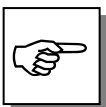

Safety Information



For Hydrocarbon Refrigeration Only See Below:

- **DANGER** – Risk of fire or explosion. Flammable refrigerant used. Do not use mechanical devices to defrost refrigerator. Do not puncture refrigerant tubing.
- **DANGER** – Risk of fire or explosion. Flammable refrigerant used. To be repaired only by trained service personnel.
- **WARNING** – Keep all ventilation openings in the enclosure or, in the structure for building-in, clear of obstruction.
- **CAUTION** – Risk of fire or explosion. Flammable refrigerant used. Consult repair manual/owner's guide before attempting to service this product. All safety precautions must be followed.
- **CAUTION** – Risk of fire or explosion. Dispose of properly in accordance with federal or local regulations. Flammable refrigerant used.
- **CAUTION** – Risk of fire or explosion due to puncture of refrigerant tubing. Follow handling instructions carefully. Flammable refrigerant used.



Replacement components and servicing

- Component parts shall be replaced with like components.
- Servicing shall be performed by authorized service personnel to minimize the risk of possible ignition due to incorrect parts or improper service.

Freeze Dry Process

Freeze drying is an important process in sample preparation and for the preservation and storage of biologicals, pharmaceuticals and foods. Of the various methods of dehydration, freeze drying (lyophilization) is especially suited for substances that are heat sensitive. Other than food processing (e.g., coffee, whole dinners), freeze drying has been extensively used in the development of pharmaceuticals (e.g., antibiotics) and preservation of biologicals (e.g., proteins, plasma, viruses and cell lines). The nondestructive nature of this process has been demonstrated by the retention of viability in freeze dried viruses and microorganisms.

Freeze drying is a process whereby water or other solvent is removed from frozen material by converting the frozen water directly into vapor without the intermediate formation of liquid water. The basis for this sublimation process involves the absorption of heat by the frozen sample in order to vaporize the ice; the use of a vacuum pump to enhance the removal of water vapor from the surface of the sample; the transfer of water vapor to a collector; and the removal of heat by the collector in order to condense the water vapor. In essence, the freeze dry process is a balance between the heat absorbed by the sample to vaporize the ice and the heat removed from the collector to convert the water vapor into ice.

Freeze Dry Rates

The efficiency of the Freeze Drying process is dependent upon the surface area and the thickness of the sample, the collector temperature and vacuum obtained, the eutectic point and solute concentration of the sample. It is important to remember these factors when trying to obtain efficient utilization of your Freeze Dry system. A listing of selected materials and their approximate drying times are shown in Table 1 for your reference.

Table 1

SAFE TEMPERATURE AND DRYING TIMES FOR SELECTED MATERIALS			
Material 10mm Thick	Safe Temperature °C	Collector Temperature °C	Hours (Approx.)
Milk	-5	-40	10
Urea	-7	-40	10
Blood Plasma	-10 to -25	-40	16
Serum	-25	-40	18
Vaccinia	-30 to -40	-50	22
Influenza Vaccine	-30	-50	24
Human Tissue	-30 to -40	-50	48
Vegetable Tissue	-50	-80	60

*Total sample quantities are contingent on various freeze dryer capacities.

Chapter 1: Introduction

Up to the point of overloading the system, the greater the surface area of the sample, the faster the rate of freeze drying. By contrast, for a given surface area, the thicker the sample the slower the rate of freeze drying. This is based on the fact that the heat of sublimation is usually absorbed on one side of the frozen sample and must travel through the frozen layer to vaporize water at the other surface. In addition, as the sample is freeze dried, the water vapor must travel through the layer of dried material. The thicker the sample, the greater the chance that the dried layer may collapse which would cause an additional decrease in the rate of freeze drying.

The surface area and thickness of the sample can usually be ignored when each sample contains only a few milliliters. However, for larger volumes, the samples should be shell frozen to maximize the surface area and minimize the thickness of the sample. The volume of the freeze dry flask should be two to three times the volume of the sample.

In order for lyophilization to occur, ice must be removed from the frozen sample via sublimation. This is accomplished by the collector and the vacuum pump. The collector, which should be at least 15 to 20°C colder than the eutectic temperature (melting temperature) of the sample, traps vapor as ice. Since the vapor pressure at the collector is lower than that of the sample, the flow of water vapor is from the sample to the collector. Since this vapor diffusion process occurs very slowly under normal atmospheric conditions, a good vacuum is essential to maintain an efficient rate. In many applications, the maintenance of a vacuum of 0.133 mbar or less is recommended.

The rate of freeze drying is directly proportional to the vapor pressure and the vapor pressure is dependent upon both eutectic temperature and solute concentration of the sample. For example, a solution of sodium chloride and water would freeze dry at a slower rate than pure water. The eutectic temperature of a sodium chloride solution is about -21°C and at this temperature the vapor pressure is about 1/16 that of water at 0°C. Although the eutectic temperature is not dependent upon the concentration of sodium chloride, the vapor pressure of the water would decrease as the concentration of sodium chloride increased. This is due to the fact that as the solute concentration increases, less of the surface area of the frozen sample is occupied by water. In general, most solutions or biological samples will have a eutectic temperature of -10 to -25°C. However, if the sample contains a simple sugar such as glucose or if the sample is animal or plant tissue, the eutectic temperature may be as low as -30° to -50°C.

Freeze Dry Capacity

The volume of a sample that can be freeze dried at one time is related to factors discussed previously and the size and design of the freeze dry system. With any given instrument, the capacity is based on the surface area of the sample; the eutectic temperature and concentration of the sample; and the rate and amount of heat transferred to the frozen sample. Of these factors, the eutectic temperature is the most important factor in determining the amount of sample that can be freeze dried at one time, particularly when flasks are used. This is because as the eutectic

temperature decreases, the vapor pressure decreases but the rate of heat absorption by the sample does not change. This tends to promote melting of the sample, which leads to a marked increase in vapor pressure and ultimately overloads the collector and vacuum pump. Samples that have eutectic temperatures of -20°C or lower should be placed on the freeze dry system one flask at a time so that the vacuum in the system may recover before adding another sample to the system. If the vacuum does not recover, the capacity of the freeze dry system has been exceeded and the sample should be removed.

If there is a problem with a particular type of sample melting when placed on the freeze dry system, dilution of the sample with more water or providing some insulation around the flask to decrease the rate of heat absorption by the sample may help. If the eutectic temperature of the sample is -40 to -60°C , the freeze dry system selected for use must be equipped with cascade type refrigeration so that the collector temperature can be cooled to below -75°C , or a dry ice/solvent trap may be used between the collector and the vacuum pump.

Samples Containing Volatile Substances

In certain cases the solvent in a sample to be freeze dried may contain volatile components such as acetonitrile, methanol, acetic acid, formic acid or pyridine. In addition to these substances having an effect on the eutectic temperature, they may increase the vapor pressure at the surface of the sample. Also, compared to water, they will require the absorption of less heat for sublimation to occur. Hence, samples that contain volatile substances will have a greater tendency to melt, particularly when placed in flasks or exposed to room temperature. If a sample containing a volatile substance tends to melt when placed on a freeze dry system, dilution of the sample with more water will help keep the sample frozen. For example, a 0.2M solution of acetic acid is much easier to freeze dry than a 0.5M solution.

About This Manual

This manual is designed to help you learn how to install, use, and maintain your Freeze Dryer. Instructions for performing routine maintenance and making minor modifications to your Freeze Dryer are also included.

CHAPTER 2

PREREQUISITES

Before you install your Freeze Dryer, you need to prepare your site for installation. Carefully examine the location where you intend to install your Freeze Dryer. You must be certain that the area is level and of solid construction. An electrical source must be located near the installation site.

Carefully read this chapter to learn:

- Electrical supply requirements.
- Vacuum pump requirements.

Refer to *Appendix C: Freeze Dryer Specifications* for complete Freeze Dryer electrical and environmental conditions, specifications and requirements.

Electrical Requirements

- 230V models
 - 20 Amp dedicated single phase circuit.
 - Properly grounded receptacle that matches the plug supplied with the unit, (230V models are supplied with one of the following plugs):

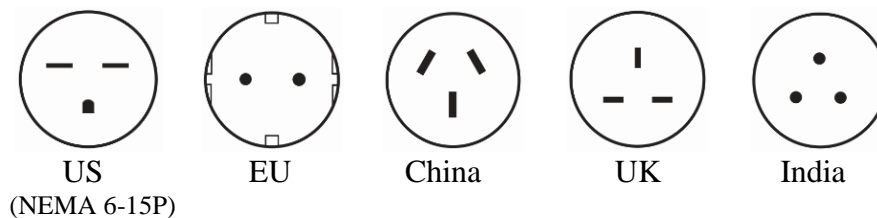

- If the plug does not match the available receptacle, remove the plug and replace it with an approved plug of the suitable style.



Do not use any detachable power cord that is not adequately rated for the unit.



Frequency must agree with the serial tag rating. Improper frequency will damage the compressor.

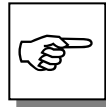

ADDITIONAL APPLIANCES ON THE SAME CIRCUIT MAY CAUSE THE CURRENT TO EXCEED THE RATING OF THE CIRCUIT BREAKER OR FUSE.

Location Requirements

The Freeze Dryer should be located in an area that provides an unobstructed flow of air around the cabinet. This air cools the refrigeration system. The refrigeration system draws air through the rear panel and exhausts it through the sides. A minimum of 3" must be allowed between the back and both sides of the Freeze Dryer and adjacent wall surfaces. Restriction of airflow during operation could adversely affect performance. The Triad Freeze Dryer must be placed on a work surface or table that will support over 400 lbs.

Refer to *Appendix B: Freeze Dryer Dimensions* for dimensional drawings.

Vacuum Pump Requirements

A vacuum pump must be provided by the user. A vacuum pump with a displacement of 98 liters per minute and 0.007 mbar ultimate pressure is adequate for most samples. The inlet fitting on the vacuum pump must be suitable for 3/4" ID vacuum hose, which is provided. It is recommended that the vacuum pump is equipped with an exhaust filter to minimize oil mist exhausting from the vacuum pump. The operating vacuum level may be set on the Freeze Dryer. The higher the vacuum set point, the more likely it is that oil mist will be exhausted.

Vacuum pumps should be equipped with a reverse IEC plug (included with 230V pumps purchased from Labconco). This will allow the vacuum pump to be plugged into the receptacle on the back panel of the freeze dryer.

CHAPTER 3

GETTING STARTED

Now that the site for your Freeze Dryer is properly prepared, you are ready to unpack, inspect, install and test your Freeze Dryer. Read this chapter to learn how to:

- Unpack and move your Freeze Dryer.
- Set up your Freeze Dryer.
- Connect the electrical supply source to your Freeze Dryer.
- Properly exhaust your Freeze Dryer.
- Safely use solvents with your Freeze Dryer.



The Triad Freeze Dryers weigh over 400 lbs (181 Kg). The carton allows for lifting with a mechanical lift truck or hand truck. If you must lift the Freeze Dryer manually, use at least two (4) persons and follow safe lifting guidelines.

Unpacking Your Freeze Dryer

Carefully unpack your Freeze Dryer and inspect it for damage that may have occurred in transit. If your Freeze Dryer is damaged, notify the delivery carrier immediately and retain the entire shipment intact for inspection by the carrier.

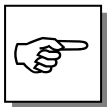

DO NOT RETURN GOODS WITHOUT THE PRIOR AUTHORIZATION OF LABCONCO. UNAUTHORIZED RETURNS WILL NOT BE ACCEPTED.

The United States Interstate Commerce Commission rules require that claims be filed with the delivery carrier within fifteen (15) days of delivery.

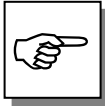

IF YOUR FREEZE DRYER WAS DAMAGED IN TRANSIT, YOU MUST FILE A CLAIM DIRECTLY WITH THE FREIGHT CARRIER. LABCONCO CORPORATION AND ITS DEALERS ARE NOT RESPONSIBLE FOR SHIPPING DAMAGE.

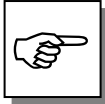

DO NOT DISCARD THE CARTON OR PACKING MATERIAL FOR YOUR FREEZE DRYER UNTIL YOU HAVE CHECKED ALL OF THE COMPONENTS AND INSTALLED AND TESTED THE FREEZE DRYER.

Freeze Dryer Components

Verify that the components listed below are present and undamaged.

Qty.	Part #	Description	Comments
1	1089005	User's Manual	<i>USB Flash Drive</i>
1	Various	Power Cord	<i>See parts list (Appendix A)</i>
1	7373450	Vacuum Hose	
2	1488800	Hose Clamp	

If you did not receive one or more of the components listed for your Freeze Dryer, or if any of the components are damaged, contact Labconco Corporation immediately for further instructions.

Setting Up Your Freeze Dryer

After you verify receipt of the proper components, move your Freeze Dryer to the location where you want to install it. Then, follow the steps listed below.

Component Identification

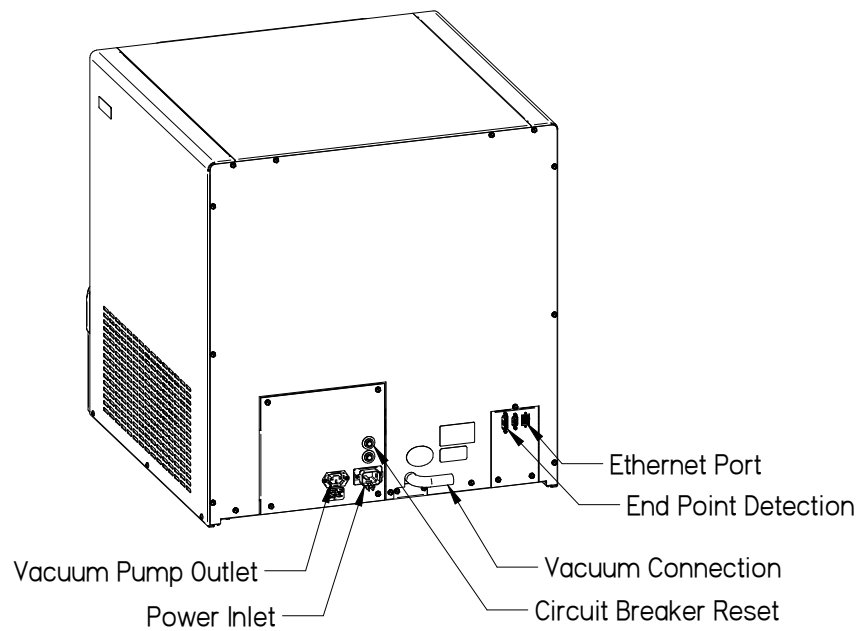
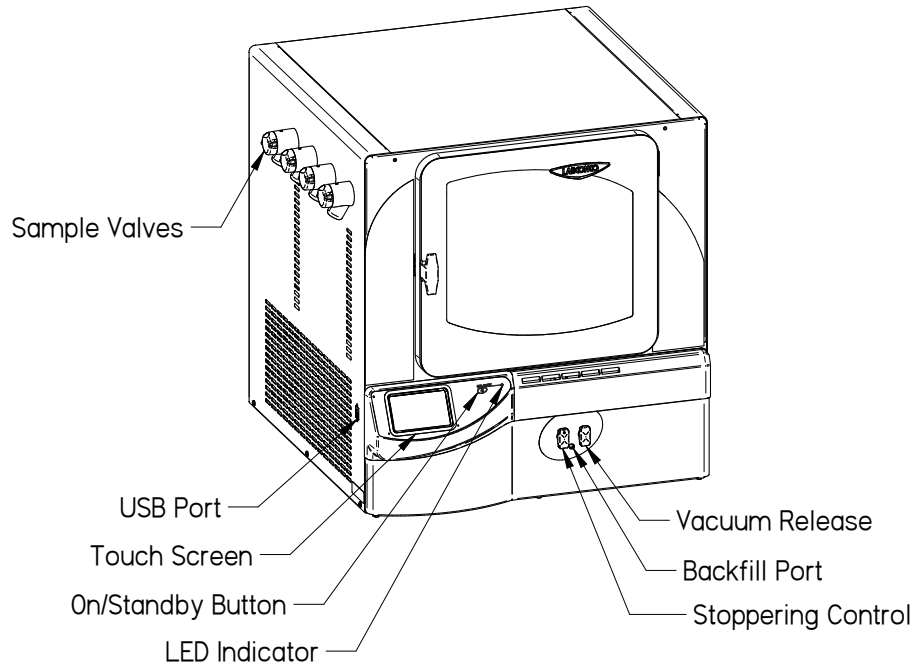

Vacuum Pump Connection

A vacuum pump (as described in *Chapter 2: Prerequisites*) is required to operate your Freeze Dryer properly. The Freeze Dryer is equipped with a 3/4" ID vacuum hose for connecting the collector chamber to the vacuum pump.

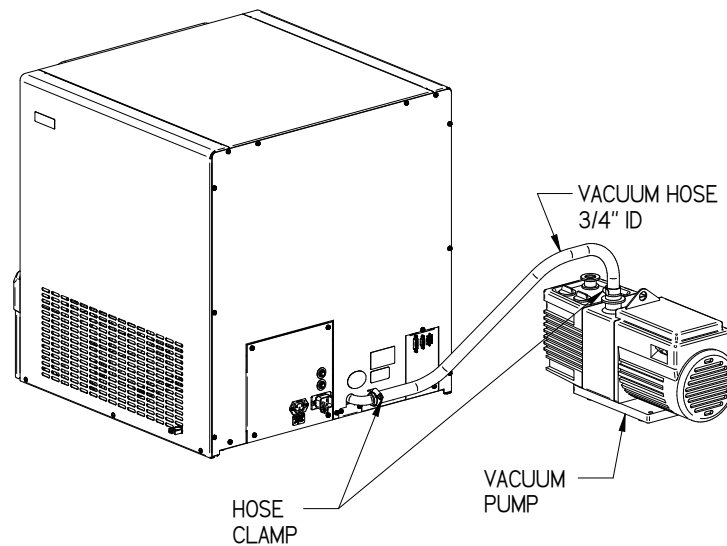

Make certain that the oil in the vacuum pump is at the proper level.

1. Place the vacuum pump near the Triad Freeze Dryer.
2. Remove protective caps from inlet and outlet ports.
3. Some vacuum pumps have inlet fittings that clamp to the pump. Place the centering ring with filter screen on the inlet fitting.
4. Place the hose barb fitting on top of the centering ring and secure with the clamp.
5. **CHECK THE VACUUM PUMP OIL LEVEL.** Fill the pump with oil so the level is between the lines on the sight gauge on the end of the pump housing.
6. Attach one end of the vacuum hose to the port on the back of the Freeze Dryer and the other end to the inlet port of the vacuum pump with the hose clamps provided. If necessary, cut the hose to proper length to allow for gentle bends without kinks.

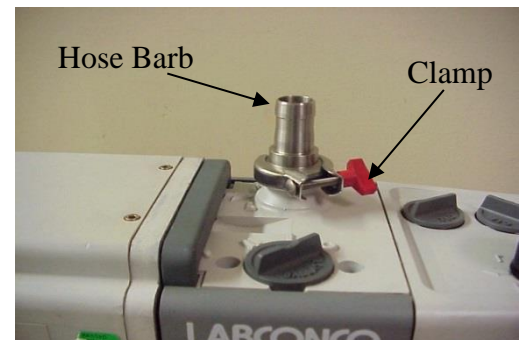
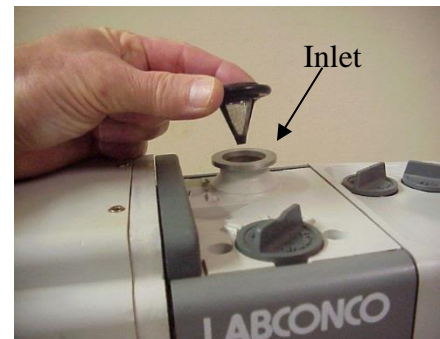

Chapter 3: Getting Started

7. VERIFY THE VACUUM PUMP VOLTAGE SETTING AGREES WITH THE FREEZE DRYER VOLTAGE SHOWN ON THE SERIAL NUMBER LABEL. Reconfigure if necessary (see vacuum pump instructions).
8. Connect the vacuum pump power cord to the receptacle labeled “vacuum pump” on the back of the Freeze Dryer. Models rated for use on 230V have a reverse IEC receptacle for attaching the vacuum pump power cord.
9. If the vacuum pump has an ON/OFF switch, turn the switch ON. The vacuum pump will be controlled by the Freeze Dryer.

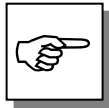

IT IS HIGHLY RECOMMENDED THAT AN OIL MIST EXHAUST FILTER BE INSTALLED ON ROTARY VANE VACUUM PUMPS TO MINIMIZE OIL MIST EXITING THE PUMP. AN OIL RETURN KIT CAN ALSO BE USED IN CONJUNCTION WITH THE EXHAUST FILTER TO RETURN TRAPPED OIL BACK TO THE VACUUM PUMP.

Electrical Connection

Make sure that the outlet that you intend to use meets the voltage and amperage requirements listed on the serial tag of the Freeze Dryer. Plug the power cord into the receptacle on the back of the Freeze Dryer and plug the other end into a suitable power outlet. It will take approximately 90 seconds for the operating system to fully load.

Chemical Resistance of Freeze Dryer Components

The FreeZone Freeze Dry System is designed to be chemically resistant to most compounds that are commonly used in freeze drying processes. However, by necessity, the freeze dryer is comprised of a number of different materials, some of which may be attacked and degraded by certain chemicals. The degree of degradation is dependent on the concentration and exposure duration. Some of the major components of the Freeze Dryer that are susceptible to degradation are as follows:

Component	Material	Acids			Buffers		Solvents							
		Acetic Acid 20%	Formic Acid	Trifluoroacetic Acid (TFA)	Calcium Chloride	Sodium Phosphate	Acetone	Acetonitrile	Carbon Tetrochloride	Cyclohexane	Dioxane	Methyl t-Butyl Ether (BTBE)	Pyridine	
Valve Stem	Acetal	C	D	D	D		D							
Collector Lid	Acrylic			D			D	D	D					
Hoses, Gaskets & Valve Bodies	Neoprene	C	D	D			C	C	D	D	D	C	D	
Flask Top	Silicon Rubber		C	D		D			D	D	D	C	D	
Chamber & Fittings	Stainless Steel					C								

C – Moderate degradation; Limited use

D – Severe degradation; infrequent use recommended; immediate thorough cleaning required.

- Most common compounds used in freeze drying processes, if allowed to enter the vacuum pump, will degrade the oil and cause damage to the vacuum pump.
- Sugars and proteins typically will have minimal negative effect on any of the materials of construction.

When using compounds in the Freeze Dryer that are hostile to the materials of construction, it is imperative the equipment is thoroughly cleaned after use.

- Rubber and plastic components that have been exposed to damaging compounds should be removed and flushed with water.
- The oil in the vacuum pump should be checked often. It must be changed if it is cloudy, shows particles or is discolored. The useful life of vacuum pump oil can be extended if the vacuum pump is operated for an extended period of time after a freeze dry run. This allows contaminants to be purged from the hot oil. This must be done with the inlet to the pump blocked off to prevent air from free flowing through the pump. If the pump is operated at an elevated vacuum level (> 10mbar), oil may be expelled from the pump and damage could occur.

Another way to extend the life of the vacuum pump is to install an optional secondary trap in the line between the Freeze Dryer and the vacuum pump. Contact Labconco for ordering information.

With prudent maintenance the Freeze Dryer will provide years of service. Warranty on the affected parts will be voided if maintenance has been obviously neglected. If you have questions about using specific compounds in the Freeze Dryer, contact Labconco Technical Service at 1-800-821-5525 or 816-333-8811 or e-mail: labconco@labconco.com.



Solvent Safety Precautions

Solvents used in the Freeze Dryer may be flammable or hazardous to your health. Use extreme caution and keep sources of ignition away from the solvents. When using flammable or hazardous solvents, the vacuum pump must be vented to or operated inside a fume hood.

Hazardous materials such as strong acids or bases, radioactive substances and volatile organics must be handled carefully and promptly cleaned up if spilled. If a sample is spilled in the collector chamber it must immediately be cleaned up.

WARNING: The disposal of substances used in connection with this equipment may be governed by various Federal, State or local regulations. All users of this equipment are urged to become familiar with any regulations that apply in the user's area concerning the dumping of waste materials in or upon water, land or air and to comply with such regulations.

CHAPTER 4

LYO-WORKS™ OPERATING SYSTEM

After your Freeze Dryer has been installed as detailed in *Chapter 3: Getting Started*, read this chapter to learn how to:

- Operate the controls.
- Understand the display.



Do not use the Freeze Dryer in a manner not specified by the manufacturer (refer to *Appendix C: Freeze Dryer Specifications*). The electrical protection properties of the Freeze Dryer may be impaired if the Freeze Dryer is used inappropriately.

Control Panel

The control panel for the Freeze Dryer is shown below with a description of its functions.



1. **Touch Screen Display** – Capacitive touch screen displays system operating parameters, set-up parameters and alarm messages. All user interface will take place via the touch screen.
2. **On / Standby Button** – If the display is illuminated pressing this button will put the display into low power mode (display backlight will be turned off). If the display is in low power mode, pressing this button will illuminate the display (Note: the display can also be brought out of low power mode by touching any location on the screen).
3. **On / Standby LED Indicator** – Blue LED indicator light to designate the current status of the system.
 - 1 flash per second = Initial power up (loading operating system)
 - Slow pulse = Touch screen in low power mode (screen timeout)
 - ON = Unit is plugged in and touch screen is in active mode
 - Off = Unit is unplugged

Initial Power Up

When the Freeze Dryer is initially plugged into a power source, the On / Standby LED will begin flashing (1 flash per second). The display will remain OFF for the first 10 to 15 seconds, then the FreeZone animated graphics will appear. It will take approximately 90 seconds for the operating system to fully load.

Touch Screen Operation

Home Screen

After initial power up, the Home screen will be displayed. Most of the general operation and system monitoring can be done from the Home screen.

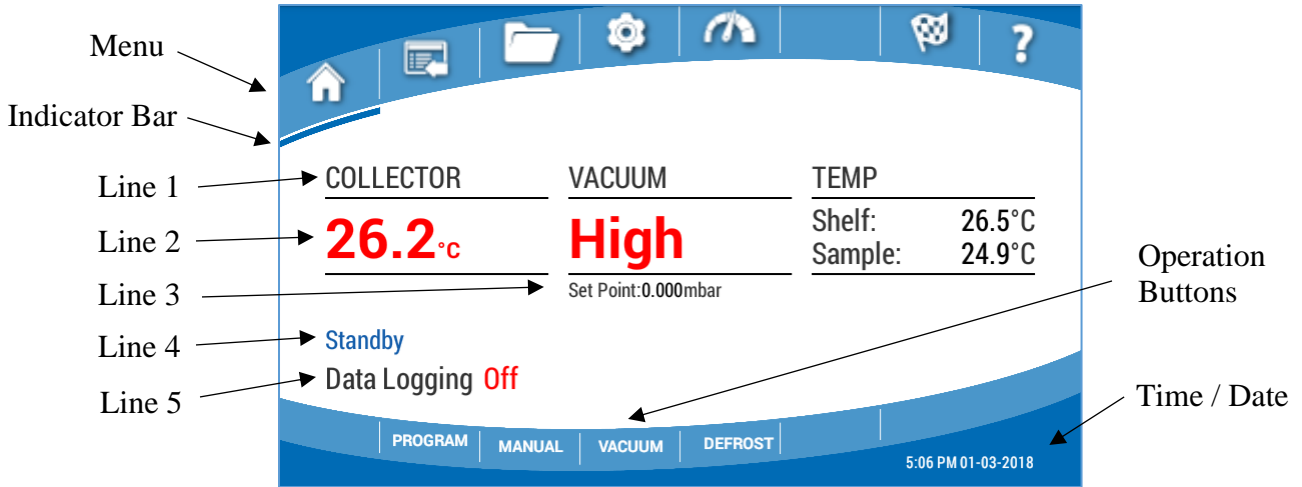

Main Menu Icons

Menu icons are displayed across the top of the screen. Their descriptions from left to right are as follows:

1. Home
2. Programs
3. Data Logging
4. Settings
5. Sensors
6. (Empty)
7. End Point Detection
8. Help

Moving between Menu Screens

You can move between menu screens by either touching the menu icons or swiping across the screen from left to right or right to left.

The Following system parameters are displayed in the center portion of the screen:

Function Indicator Bar

A thin blue indicator bar will appear under the icon of the menu screen that is currently being displayed. The same type of indicator bar will appear above the operation buttons to signify if each function is ON or OFF.

System Parameters Display

Line 1

COLLECTOR, VACUUM & TEMP HEADING – Describes the measurement that is displayed directly below the text.

Line 2

COLLECTOR MEASUREMENT - Displays the temperature of the collector coil in °C or °F (as selected in Settings). The value displayed will be **RED** if the temperature is > -60° C. The value displayed will be **GREEN** if the temperature is ≤ -60° C.

VACUUM MEASUREMENT – Displays the Freeze Dryer vacuum level in mbar, Pa, or Torr (as selected in Settings). The display will read “High” if the vacuum level is > 5 mbar. If the vacuum level is ≤ 5 mbar, a numerical value will be displayed. The value displayed will be **RED** if the vacuum is > 1.500 mbar. The value displayed will be **GREEN** if the vacuum is ≤ 1.500 mbar.

SHELF & SAMPLE TEMPERATURE MEASUREMENT – Displays the shelf & sample temperatures in °C or °F (as selected in Settings).

Line 3

Vacuum Set Point – Displays the current vacuum set point in mbar, Pa, or Torr (as selected in Settings) in the center section Line 3.

Line 4

Operation Mode – Indicates the current status of the Freeze Dryer. One of the following will always be displayed on this line:

1. **Standby** – Collector and Vacuum are both OFF
2. **Manual** – Collector and/or Vacuum are ON, but no Program is currently running.
3. **Program** – If a program is currently running this line will display the actual Program Name, Step #, and Time Remaining (hh:mm) in the current step of the program.
4. **Defrost** – Defrost will be displayed when the hot gas defrost function is turned ON.

Line 5

Data Logging Status – **On** or **Off**

Operation Buttons

Operation buttons are displayed across the bottom of the Home screen.

- **PROGRAM** – This button opens the PROGAMS screen described in the next section.
- **MANUAL** – Use this button to turn the collector & shelf control ON/OFF. There are 3 different modes to choose from within the MANUAL function:
 - **Max Cold** – This setting allows the shelf to be used to freeze samples below -55°C , obtaining “Max Cold” (MC) temperature of approximately -75°C . Max Cold should only be used for pre-freezing samples, not for freeze drying, since the collector coil is not being cooled in this mode.
 - **In-Flask** – This setting is used to freeze dry pre-frozen samples when using ONLY the sample valves on the left side of the unit. There is no shelf temperature control in this mode.
 - **Shelf Temp Set Point** – When using this mode the shelf temperature will maintain the set point selected. The shelf temperature may be set in the range from $+50^{\circ}\text{C}$ to -55°C in 1°C increments.

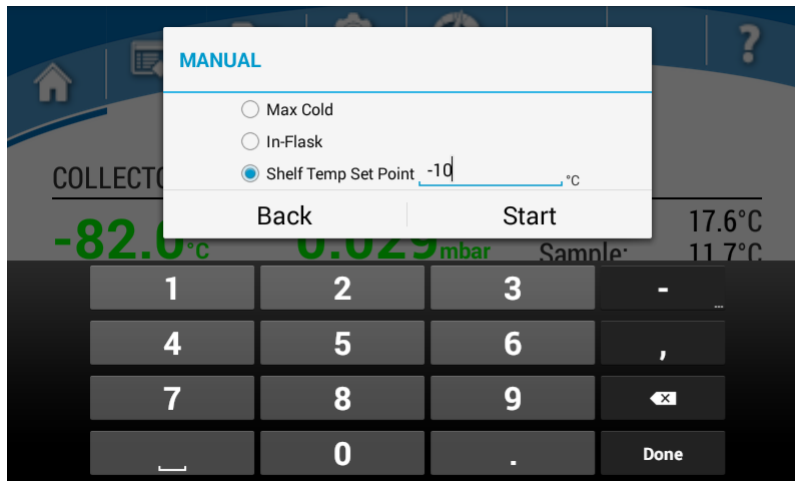

- **VACUUM** – Use this button to turn the vacuum pump ON/OFF or change the vacuum set point value.
- **DEFROST** – Use this button to turn the defrost mode ON/OFF. The defrost function will turn off automatically if the collector temperature reaches $+60^{\circ}\text{C}$ or if defrost has been running for 2 hours.

Programs Screen

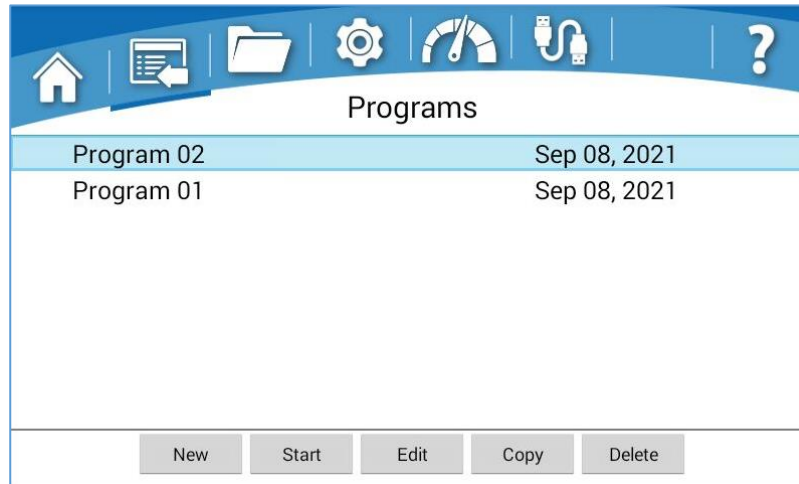

The Programs screen will allow you to create and store programs that are used to control the shelf temperature and vacuum level. When no program has been selected the “New” button will be the only active button along the bottom of the screen. A program can be selected from the program list by pressing the program name. When a program has been selected, the program row will be highlighted (blue). With a program selected, the rest of the buttons along the bottom of the screen will become active (Start, Edit/View, Copy & Delete).

- **New** – Use this button to add a new program to the program list. The new program name will be defaulted to a two-digit sequential number (starting with “Program 01”) that will be incremented as new programs are added to the list (i.e., Program 02, Program 03...). The default name can be edited as desired in the New or Edit screen.
- **Start/Stop** – Use this button to start or stop a program. The wording on this button will change from “Start” to “Stop” depending on whether a program is currently running.
- **Edit/View** – Use this button to Edit or View the parameters of a saved program (the wording on this button will change from “Edit” to “View” depending on whether the program is locked or unlocked for editing).
- **Copy** – Use this button to Copy a selected program. The default name will be “*Program Name_copy*”. The program name can be edited as desired.
- **Delete** – Use this button to delete a saved program from the list.

When a program is currently in progress, a “running man” icon will appear to the left side of the program name. If the running program is selected (highlighted), the “Stop” button will be active, and the “Delete” button will be inactive.

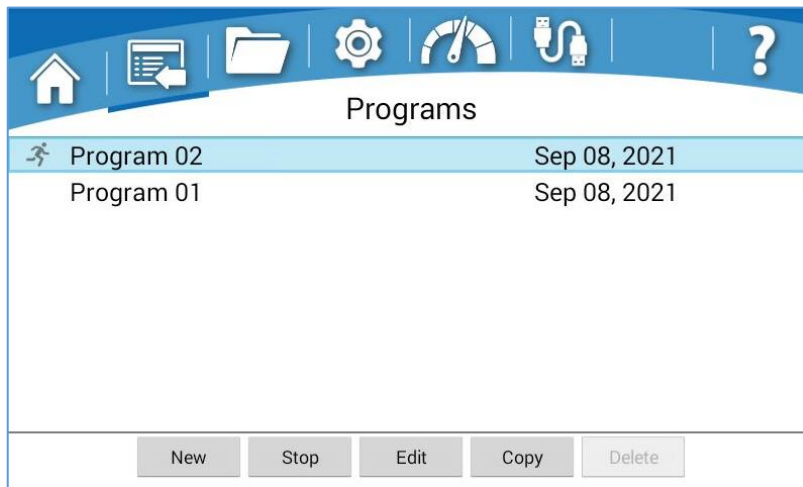

“New” program

When the “New” button is selected, the following screen will be displayed.

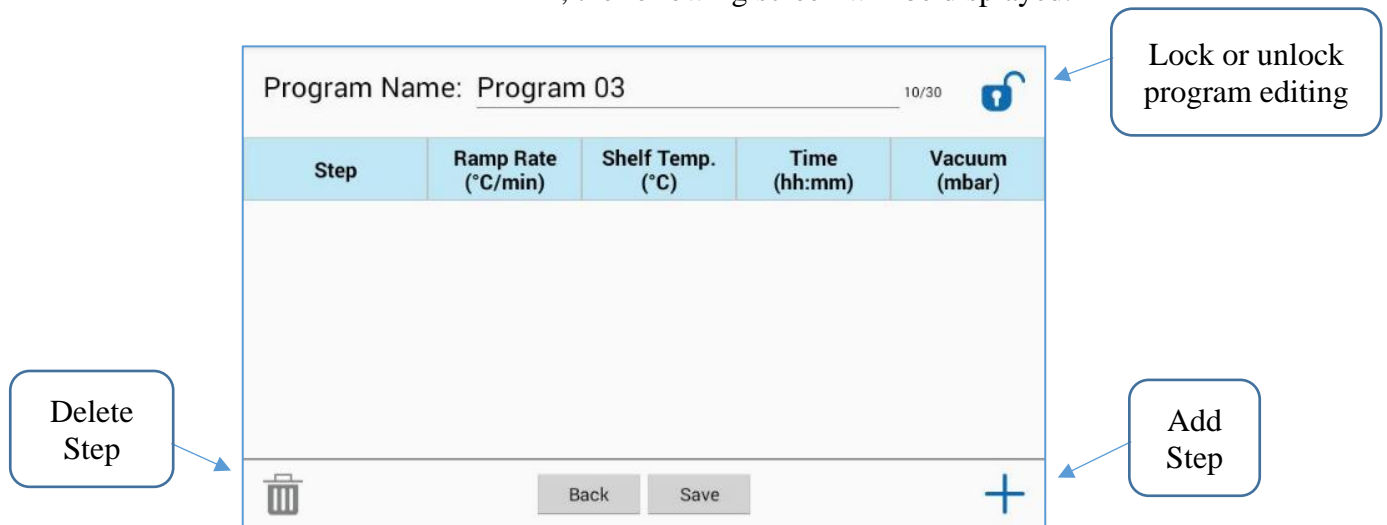

Pressing the program name field will allow you to edit the program name. The “Add” button will add a new Step to the program and take you through a series of screens to set the Ramp Rate, Shelf Temp., Time, and Vacuum. Values can be edited by pressing any of the cells. Pressing the “Delete” button will delete the selected step from the program. Changes will not be saved until the “Save” button is pressed. Pressing the “Back” button will return to the Programs screen without saving changes.

- Ramp Rate** – This allows the temperature of the system to be increased or decreased at any desired rate within the capacity of the heating and cooling systems of the Freeze Dryer. Without samples on the shelf, the system is capable of cooling at a rate of approximately 0.5°C/min from 50°C to 0°C, .25°C/min from 0°C to -55°C, and can heat at approximately 3°C/min. Ramp Rate may be set anywhere from 0.05°C to 3.0°C/min.

Chapter 4: Lyo-Works Operating System

- **Shelf Temp.** - May be set anywhere from +50°C to –55°C in 1°C increments. There is also a Max Cold (MC) setting that allows the system to reach its lowest possible temperature (approximately -75°C). Max Cold should only be used for pre-freezing samples, not for freeze drying, since the collector coil is not being cooled in this mode.
- **Time** – This time represents how long the system will hold at the Shelf Temp. that has been programmed for each Step. The time can be set from 00:01 to 99:59 (1 min to 99 hrs 59 min). It can also be set to an indefinite amount of time, which is represented by the infinity symbol (∞).
- **Vacuum** – Vacuum control can be set from 0.000 to 1.500 mbar.

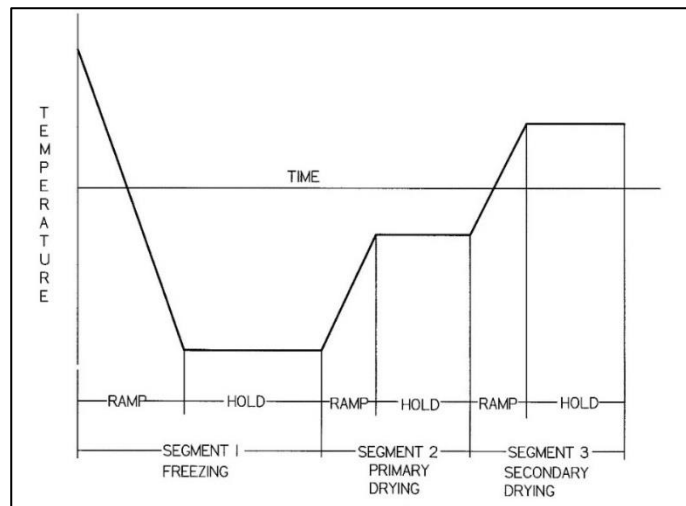
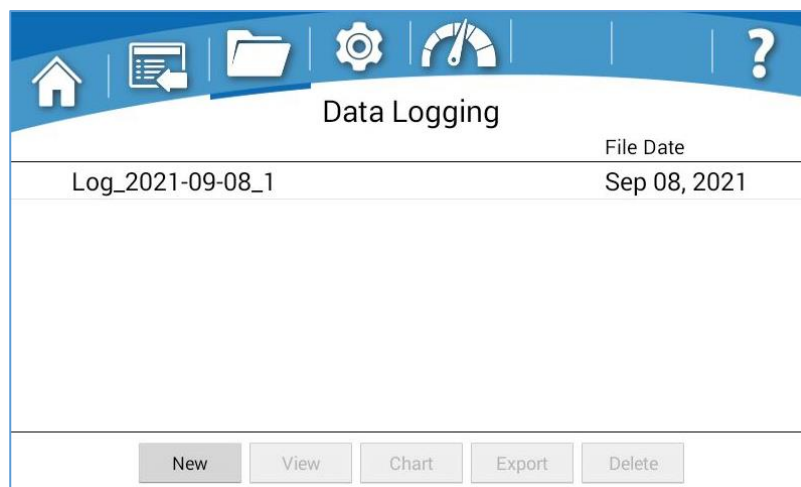

Illustration of a simple 3 Step Program

Data Logging Screen



If no data log file has been selected the “New” button will be the only active button along the bottom of the screen. A data log file can be selected from the list by pressing the data log file name. When a data log file has been selected, the row

will be highlighted (blue). With a data log file selected, the rest of the buttons along the bottom of the screen will become active (View, Chart, Export & Delete). If a data log file is currently running (collecting data), the “running man” icon will appear to the left of data log file name. If the currently running data log file is selected (highlighted), the Delete button will be inactive.

- **New/Stop** – Use this button to start a new data log file or to stop a running data log file. The wording on this button will change from “New” to “Stop” depending on whether a data log file is currently running. The new data log file name will be defaulted to the format shown above that includes the date the file was started and an incremental number to distinguish multiple files with the same date. The default name can be edited as desired in the New or View screen.
- **View** – Use this button to view the data from a saved data log file in table format.
- **Chart** – Use this button to view data from a saved data log file in chart format (1 temperature sensor & 1 vacuum sensor can be graphed at a time). Temperature and vacuum sensors can be selected from pop-up menus.
- **Export** – Use this button to export a selected data log file to a USB flash drive or computer via the USB port on the left side of the Freeze Dryer.
- **Delete** – Use this button to delete a saved data log file from the list.

Settings Screen

Many of the user preferences may be configured from the Settings menu. Before operating the freeze dryer, you may want to configure some of the available preferences.

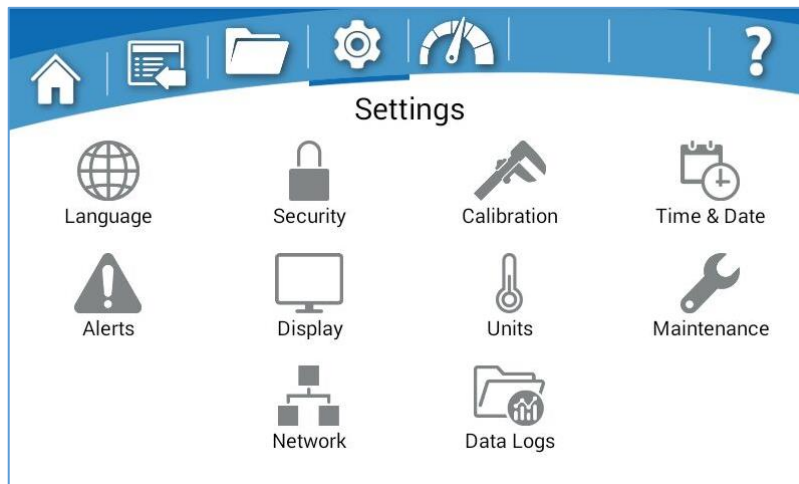

1. **Language** – Chose from 5 languages: English, Spanish, French, German, Italian
2. **Time/Date** – Chose Clock Format (12 or 24 hour), Set Time, Set Date for manually setting the time and date. The Auto Update time & date feature can be used if a valid network connection has been established. With Auto Update the following settings need to be entered:

Chapter 4: Lyo-Works Operating System

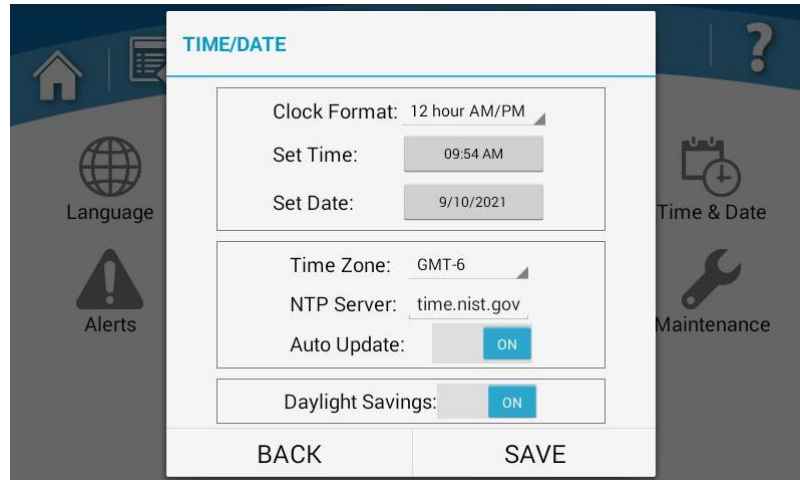

- **Time Zone** – Enter the Greenwich Mean Time (GMT) offset value for your location (integer value between -12 & +12).
 - **NTP server** – Enter the “web address” (URL) of the NTP server (of your choice) that will provide clock synchronization data to the Freeze Dryer via the Ethernet connection.
 - **Daylight Savings (ON/OFF)** – When Auto Update is ON, this feature can be used to adjust the time for areas observing Daylight Savings Time (DST).
3. **Units** – Select your desired unit of measure for Temperature (°C, °F) and Vacuum (mbar, Pa, Torr)
 4. **Security** – A four-digit security code can be set that will require users to enter the code to gain access to selected screens. A security code will always be required to enter the “Security” screen.

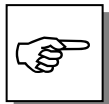

THE FACTORY DEFAULT SECURITY CODE IS “1234”

Security	
Security Code required to access or modify:	
<input type="checkbox"/>	System
<input type="checkbox"/>	Programs
<input type="checkbox"/>	Email Alerts
<input type="checkbox"/>	Calibration
<input type="checkbox"/>	Network
<input type="checkbox"/>	Data Options
Back	Set Code
OFF	

- **System** – If the System security feature is selected (box checked), users will be required to enter the security code to gain access to the touch screen controls when the screen is reactivated from a screen timeout (sleep mode) or power failure (screen timeout described in the Settings/Display section).
 - **Programs, Email Alerts, Calibration, Network, Data Options** – Users will be required to enter the security code to gain access to each individual screen that has been selected (box checked).
5. **Alerts** – If a valid network connection has been established (via the Settings / Network screen) and Email Settings have been properly configured, alerts can be emailed to selected users, by entering the appropriate email address(es) and selecting the type of alerts that will be sent to each email address.

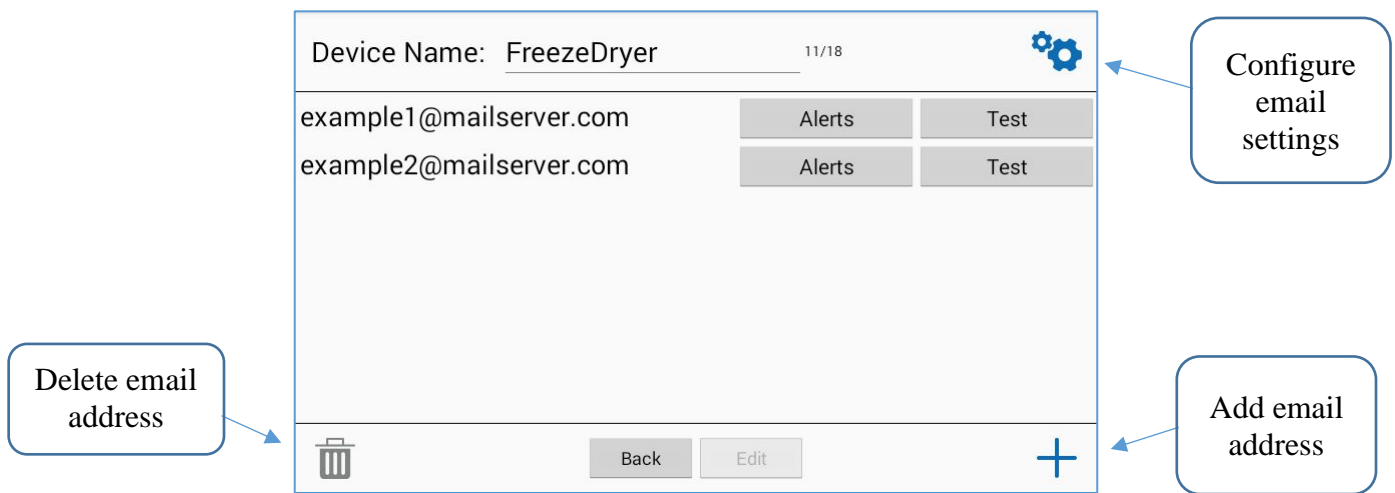

The Edit & Delete buttons will be inactive until an email address is selected from the list. When an email address has been selected, it will be highlighted (blue).

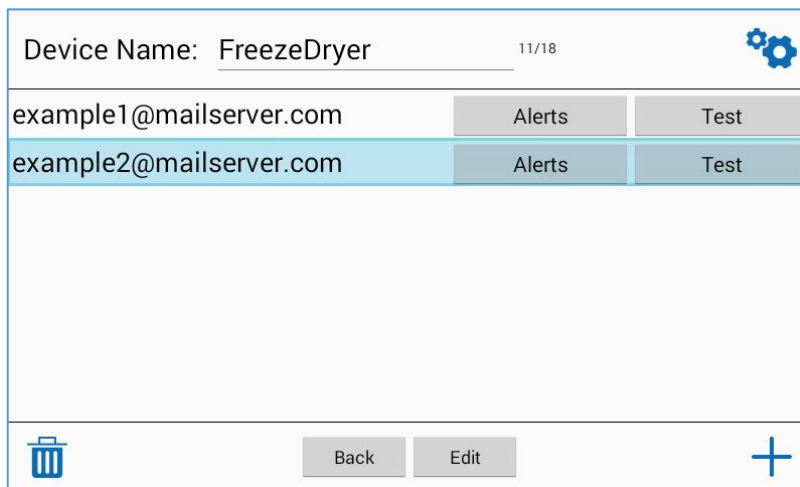

- **Add** – Use this button to add a new email address to the list.
- **Edit** – Use this button to edit an existing email address.

Chapter 4: Lyo-Works Operating System

- **Delete** – Use this button to delete an existing email address.
- **Device Name** – The default name for this field will be “Freeze Dryer”. The name can be edited by pressing the name field.
- **Configure Email Settings** – Pressing this button will bring up the following screen, where the appropriate email settings can be entered.

The screenshot shows a mobile application interface. At the top, there's a header 'Device' and a gear icon. Below it, a list of devices is visible, with 'example' and 'example2' partially shown. A modal window titled 'EMAIL CONFIGURATION' is open in the center. It contains the following fields: 'SMTP Server:' with an empty text input; 'SMTP Username:' with an empty text input; 'SMTP Password:' with an empty text input; 'SMTP Port Number:' with a numeric input containing '0'; and 'Encrypted Connection:' with a toggle switch set to 'ON'. At the bottom of the modal are 'BACK' and 'SAVE' buttons. In the background, a 'Test' button is visible next to the device list.

If you do not know the proper information to enter into each of the SMTP fields, consult your IT personnel or email service provider.

After entering the appropriate information in all of the SMTP fields, press the Save button. The system will check the information entered into each field to make sure each entry is valid. If one or more invalid entries are found the following message will appear: *EMAIL SETTINGS ERROR – Unable to test email: (followed by more description depending on type of entry error)*.

If all the SMTP fields entered are valid, but the network connection is not working (or Ethernet cable is not connected) the following message will appear after pressing the Save button: *EMAIL SETTINGS ERROR – Network connection is not active*

- **Test** – After the Email Settings and Network Settings have been correctly entered, pressing this button will send a test email to the selected email address.
- **Alerts** – The type of alerts that will be sent to each individual email address can be customized. Pressing the Alerts button will bring up the following selection list. Alerts can be selected or deselected by pressing the check box in front of each alert. Scroll list up or down by swiping screen up or down.

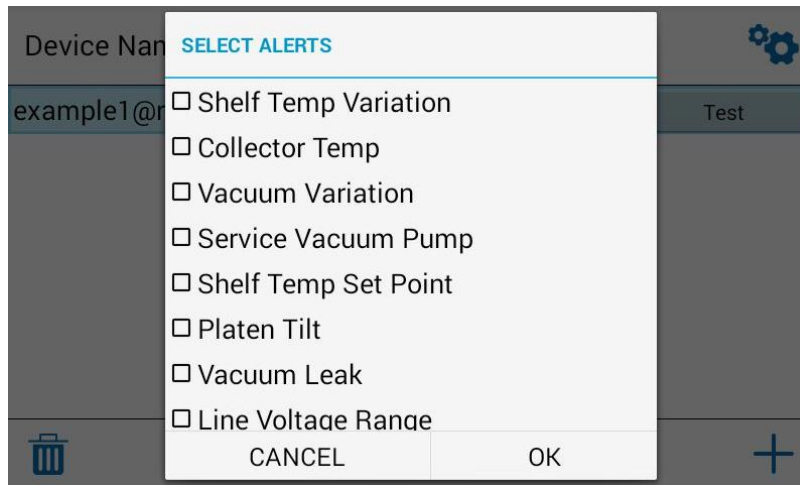

6. **Maintenance** – This screen contains data and settings pertaining to the operation hours and maintenance period for the vacuum pump and refrigeration system. Scroll up and down to view the entire page.

- **Line Voltage Offset** - These offset values determine the acceptable voltage range for electrical power supplied to the Freeze Dryer. If the supply line voltage is outside of the acceptable range, then the Line Voltage Range alert will be displayed. The default range is +/- 12.5% of the nominal rated voltage (115V or 230V depending on model). The LOW Line Voltage Offset can be adjusted from 0 to -10V (115V models) or 0 to -20V (230V models). The HIGH Line Voltage Offset can be adjusted from 0 to +10V (115V models) or 0 to +20V (230V models). Scroll up and down to view the entire page.
- **Vacuum Pump Protection** – If vacuum pump protection is turned ON, the vacuum pump will automatically be turned off if a “Vacuum Leak” alert is presented. This will protect oil filled pumps from losing their oil and potentially damaging the pump in the event of a major vacuum leak. **The factory default setting for vacuum pump protection is ON, and it is highly recommended that it remain in the ON setting.** If vacuum pump protection is turned OFF, the pump will continue to run after a “Vacuum Leak” alert is presented (i.e. there is no protection for the pump in the event of a major vacuum leak).

Maintenance	
Vacuum Pump Settings:	
Operating hours since oil change:	0 Reset
Set hours between oil change:	1000
Date of last oil change:	Unknown
Total operating hrs for this pump:	0 Reset
Refrigeration System Settings:	
Total operation hrs:	0
Back	

Chapter 4: Lyo-Works Operating System

Maintenance			
Total operating hrs for this pump:	0	<input type="button" value="Reset"/>	
Refrigeration System Settings:			
Total operation hrs:	0		
Date of last service/cleaning:	Unknown		
Freeze Dryer Line Voltage Offset:	0	<input type="button" value="Low"/>	<input type="button" value="High"/> 0
Vacuum Pump Protection	<input checked="" type="checkbox"/> ON		
<input type="button" value="Back"/>			

7. **Calibration** – Some sensors in the Freeze Dryer can be calibrated. This process should be done by a qualified technician or metrologist with reference sensors that are known with certainty. An external reference sensor must be placed at the same measurement point (as close as physically possible) as the sensor being calibrated. The Collector and Shelf temperature sensors have their own reference thermocouple (type T) built into each sensor. Each thermocouple is a pair of wires (red & blue) sheath with a brown outer casing. They are located inside the housing of the Freeze Dryer and can be accessed by removing the back panel. A thermocouple meter can be used to read the thermocouple value as a reference value.

Sensor Calibration			
Sensor Name	Current Reading (uncorrected)	Offset	Last Cal. Date
Collector	26.8°C	0.0	09-10-2021
Vacuum	High	0.000	09-10-2021
Shelf	26.7°C	0.0	09-10-2021
<input type="button" value="Back"/>			

- **Current Reading (uncorrected)** – This gives the raw sensor reading with no offset applied to the reading.
- **Offset** – This is the value that will be added to the Current Reading (uncorrected) to give the proper adjusted reading that matches the reference sensor being used for calibration. The adjusted reading (uncorrected + Offset) is the value that will be presented on all screens outside of the Sensor Calibration screen. Pressing the Offset field of the desired sensor will bring up a dialog box for entering the offset value for the selected sensor.



- **Calibrate** - Pressing this button will save the entered offset value. Temperature sensor offset values can range from -5 to +5° C. Vacuum Sensor offset values can range from -0.020 to +0.020 mbar.
8. **Display** – This screen contains settings for controlling various functions of the touch screen display.

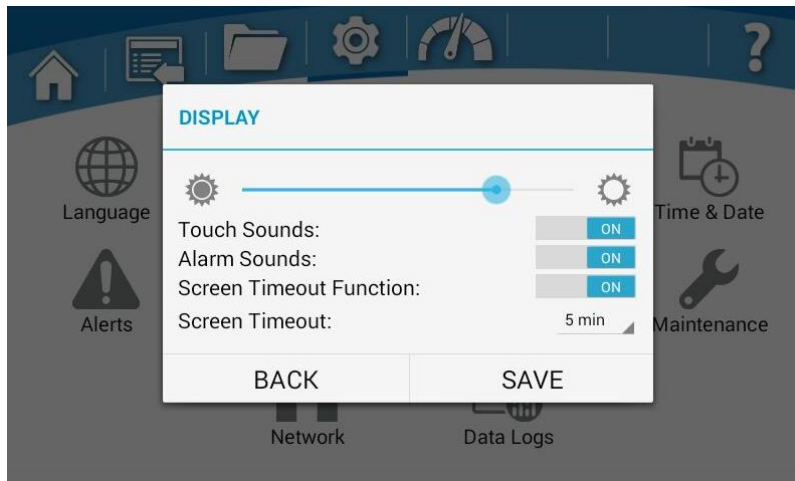

- **Brightness Slider** – Moving the slider to the right will increase the brightness level, moving to the left will decrease the brightness level of the display.
- **Touch Sounds** – With Touch Sounds turned ON, there will be an audible sound each time the display is touched. Pressing the Touch Sounds button will toggle between ON & OFF.
- **Alarm Sounds** – With Alarm Sounds turned ON, there will be an audible sound each time an alert message is displayed.
- **Screen Timeout Function** – If this function is turned ON, the screen will go into low power mode (sleep) when no screen touches have been detected for the allotted set time (Screen Timeout). Pressing the Screen Timeout Function button will toggle between ON & OFF.
- **Screen Timeout** – This value can be set to 5, 10, 15, 30 min, 1, 2, or 3 hours.

Chapter 4: Lyo-Works Operating System

9. **Network** – If the DHCP Enabled button is turned ON, and an Ethernet cable is connecting the Freeze Dryer to an active network, then the IP Address, Subnet Mask, and Default Gateway fields will be populated automatically. If the DHCP Enabled button is turned OFF, the IP Address, Subnet Mask, and Default Gateway fields can then be manually entered to establish a network connection. If you do not know the proper information to enter into each of the Network fields, consult your IT personnel.

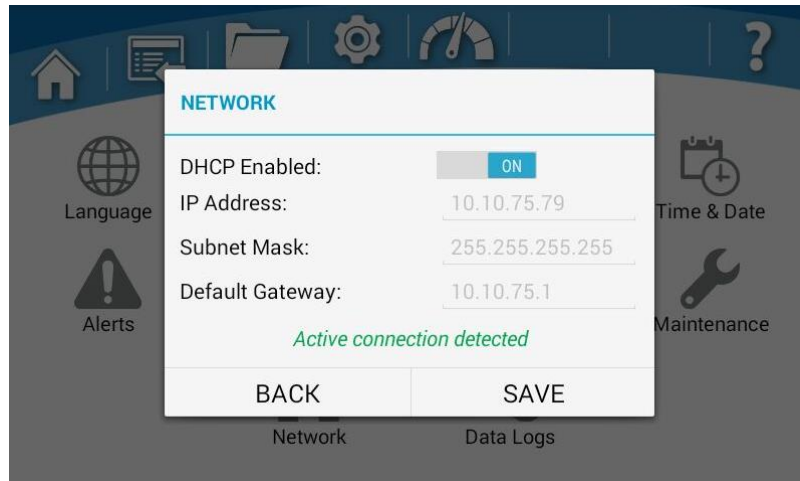

10. **Data Logs** – Allows user to make changes to default settings for Data Acquisition Rate, Log File Deletion and Data Export Options.

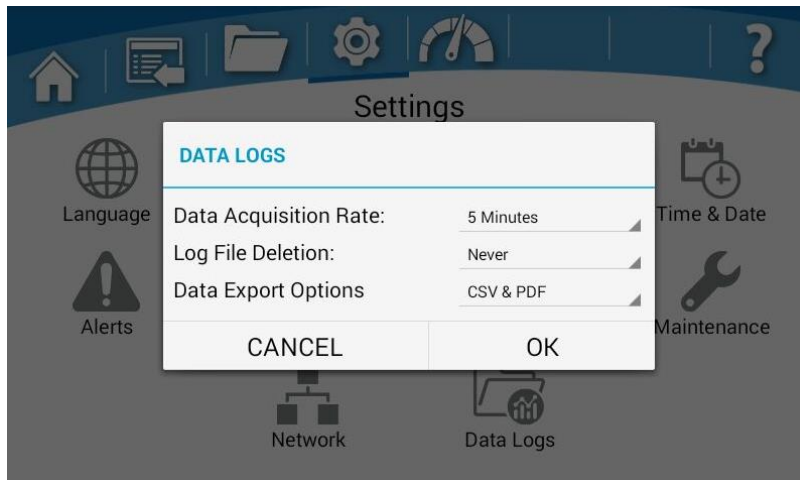

Sensors Screen

This screen contains a list of all sensors currently installed on the Freeze Dryer and any attached accessory. The Sensors screen is for viewing only (there are no selectable fields on this screen).

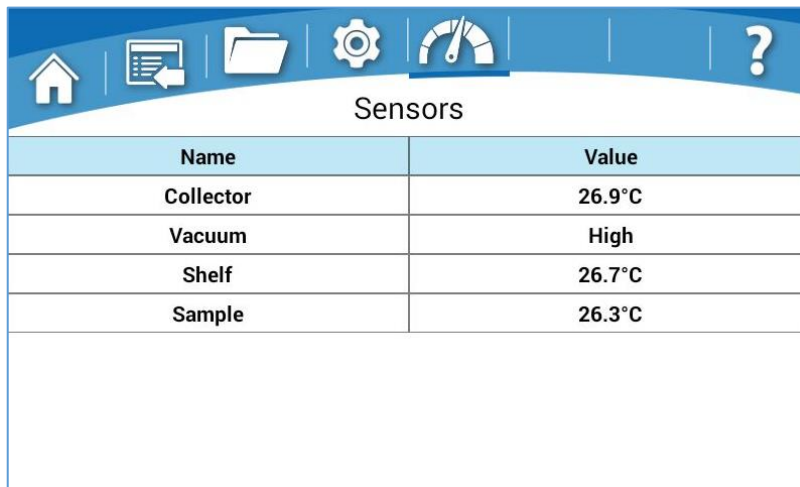

Sensors	
Name	Value
Collector	26.9°C
Vacuum	High
Shelf	26.7°C
Sample	26.3°C

End Point Detection Screen

If the communication cable is NOT connected or if NONE of the vacuum sensors are connected to the End Point Detection Enclosure, the End Point Detection icon (checkered flag) will NOT appear in the menu bar. If the End-Zone end point detection accessory is properly connected to the Freeze Dryer, this screen will be used to control the End Point Detection settings for up to five individual freeze dry flasks.

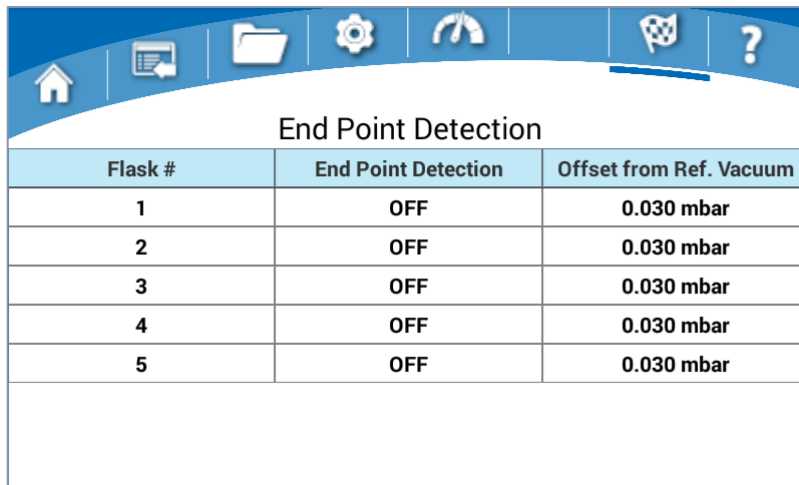

End Point Detection		
Flask #	End Point Detection	Offset from Ref. Vacuum
1	OFF	0.030 mbar
2	OFF	0.030 mbar
3	OFF	0.030 mbar
4	OFF	0.030 mbar
5	OFF	0.030 mbar

- **End Point Detection status** – Shows the current status for each flask. The status will be one of the following: ON, OFF or COMPLETE. Touching the end point detection cell for any given flask will allow you to turn the end point detection ON/OFF. The End Point Detection status will display COMPLETE automatically when an End Point Detection alert is achieved for any given flask.
- **Offset from Ref. Vacuum** – This allows the user to determine the level of dryness at which the system will declare that the primary drying end point has been reached. The offset from Ref. Vacuum represents the difference between the Reference vacuum sensor and the individual

Chapter 4: Lyo-Works Operating System

flask sensor. This value can be set from 0.010 to 0.050 mbar (0.010 being the most dry & 0.050 being the least dry).

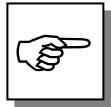

END POINT DETECTION INDICATES THE END OF THE PRIMARY DRYING PHASE. SOME SAMPLES MAY REQUIRE ADDITIONAL FREEZE DRYING TIME (SECONDARY DRYING PHASE) TO ACHIEVE THE DESIRED MOISTURE CONTENT.

Help Screen

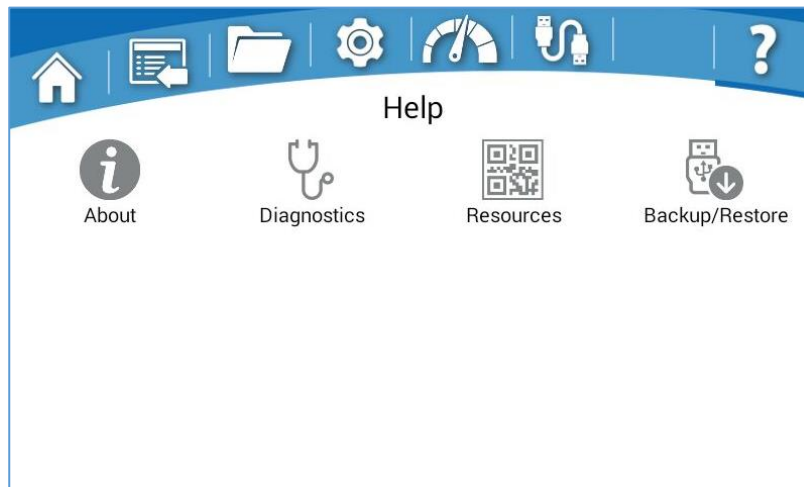

- **About** – Displays the catalog number of the Freeze Dryer and the software versions currently installed.
- **Diagnostics** – This screen will give information about the power supply to the Freeze Dryer (Voltage, Current & Frequency) and allow the user to run Manual or Auto Diagnostics on the unit.

Diagnostics	
Triad 211 V 0.1 A 60 Hz	
COMPONENT	Test Result
▶ Run Auto Diagnostics	
▶ DEFROST VALVE RELAY	
▶ VENT VALVE	
▶ REFRIGERANT VALVE	
▶ VACUUM RELAY	
<input type="button" value="Back"/> <input type="button" value="Export USB"/> <input type="button" value="Export Email"/>	

- **Resources** – Scan QR codes with smart phone to take you to specific pages of the Labconco website (Labconco.com).



- **Backup/Restore** – Log files & User Programs can be exported to a USB flash drive. Only user program can be imported to the Freeze Dryer from a USB flash drive.

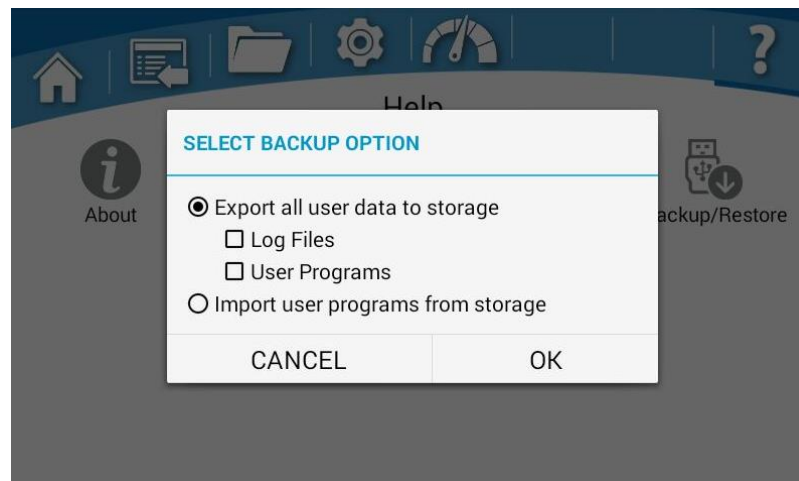

CHAPTER 5

USING YOUR FREEZE DRYER

Operation Checklist

The following checklist should be followed prior to each use of your Freeze Dryer:

1. Wipe out the interior of the chamber with a soft cloth or paper towel to remove any moisture or debris.
2. Check the collector tray drain hose to ensure that the hose is free of moisture and that the drain plug is securely installed.
3. Using a soft, lint-free cloth or paper towel, wipe the door gasket to remove any dirt and contaminants that could cause a vacuum leak. Vacuum grease is not required on the door gasket.
4. Check that each sample valve is closed or in the “vent” position. See Figure 4.

Vacuum Pump Ballast Setting

Most vacuum pumps are equipped with a gas ballast mechanism. The freeze dry process requires high vacuum. Therefore, it is recommended that the gas ballast be closed during the operation of the Freeze Dryer.

Note: If the gas ballast is left open for extended periods of operation, the oil can be pumped out the exhaust, causing the pump to fail.

Sample Freezing

Before the freeze dry process can occur, the products to be dried must be in a frozen state. This can be accomplished in a freezer separate from the freeze dryer or on the shelf inside the Freeze Dryer. If the shelf inside the Freeze Dryer will be used to pre-freeze samples, make sure that the vacuum is turned off until the samples are fully frozen.

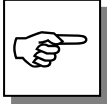

THE VACUUM SHOULD ALWAYS BE TURNED OFF WHILE USING THE SHELVES TO FREEZE SAMPLES

The sample container volume should be at least two to three times greater than the sample volume. The temperature required for pre-freezing is dependent on the characteristics of the sample. Pre-freezing temperature is typically at least 10° to 20°C below the eutectic or collapse temperature of the sample. Pre-freezing on the Triad shelf can be done in Manual or Program modes as long as the shelf set point temperature is adequate to fully freeze the sample.

In **MANUAL** mode, simply set the Shelf temperature to the desired value for freezing the sample, and allow an appropriate amount of time for the sample to be fully frozen before starting the vacuum and the freeze drying process.

In **PROGAM** mode, the vacuum set point can be programmed to **OFF** for the initial pre-freezing step. If multiple steps are desired for more complex pre-freezing/annealing processes, then program the vacuum set point to **OFF** for each of the pre-freezing / annealing steps.

If desired, place the sample probe in a sample vial to monitor the sample temperature throughout the pre-freezing & freeze dry process.

Shelf Loading

The stoppering mechanism is capable of generating a very strong force, which could damage the shelf or mechanism. Therefore, it is important to distribute the serum bottles to be stoppered evenly across the entire surface of the shelf. When stoppering vials, always place a vial on each corner of the shelf.

Setting the Operating Vacuum Level

To change the Vacuum Set Point

1. Go to Home screen
2. Press **VACUUM**,
 - enter new Vacuum Set Point value
 - press **APPLY** (or **START** if vacuum pump is not already running)

The vacuum level may be set by the user to optimize the freeze dry process. Normally, the sublimation rate will increase as the pressure increases in the Freeze Dryer. A good starting place is to set the vacuum so its level is equivalent to about 10°C colder than the eutectic or collapse temperature of the sample. The reference table below shows the relationship between ice temperature and vapor pressure.

Chapter 5: Using Your Freeze Dryer

Vapor pressure above ice

Temp. (°C)	Pressure (mbar)	Temp. (°C)	Pressure (mbar)	Temp. (°C)	Pressure (mbar)	Temp. (°C)	Pressure (mbar)	Temp. (°C)	Pressure (mbar)
0	6.11	-11	2.37	-21	0.94	-31	0.34	-50	0.039
-1	5.63	-12	2.17	-22	0.85	-32	0.31	-60	0.011
-2	5.18	-13	1.98	-23	0.77	-33	0.28	-70	0.003
-3	4.76	-14	1.81	-24	0.70	-34	0.25	-80	0.001
-4	4.37	-15	1.65	-25	0.63	-35	0.22		
-5	4.02	-16	1.50	-26	0.57	-36	0.20		
-6	3.69	-17	1.37	-27	0.52	-37	0.18		
-7	3.38	-18	1.25	-28	0.47	-38	0.16		
-8	3.10	-19	1.13	-29	0.42	-39	0.14		
-9	2.84	-20	1.03	-30	0.38	-40	0.13		

Adjustments to the vacuum level must be made for various freeze drying conditions. Factors that must be considered are whether the sample is freeze dried on heated shelves or in glassware attached to sample valves, the volatility of the sample itself, the size of the sample and the heat energy supplied to the sample. When the vacuum control is set to operate at less vacuum (higher pressure), the ice holding capacity of the collector may be decreased. Some guidelines for setting the vacuum level are shown below. Exact protocols must be determined by the user for the specific samples that are being freeze dried.

Material	Solidification/Eutectic Temperature	Pre-Freeze Temperatures	Vacuum Set Point
Bacteria, Virus	≤ -40°C	≤ -50°C	≤ 0.04 mbar
Milk	-5 to -13	-15 to -23	1.65 to 0.77
Fungi	≤ -40	≤ -50	≤ 0.04
Vegetable Tissue	-25 to -50	-35 to -60	0.22 to 0.01
Human Tissue	-30 to -40	-40 to -50	0.12 to 0.04
Blood Plasma	-10 to -25	-20 to -35	1.03 to 0.22
Vaccine	-30 to -40	-40 to -50	0.12 to 0.04

Freeze Drying Inside the Chamber

The following procedure should be followed when freeze drying using the temperature controlled shelf inside the vacuum chamber.

Manual Mode with Pre-frozen Samples

1. Go to the Home Screen and press MANUAL
2. Enter the desired shelf set point temperature and press Start.
3. The system will begin ramping the shelf temperature until the set point temperature is achieved. After reaching the set point temperature, the system will hold at this temperature indefinitely.
4. When the collector temperature reaches -80°C and the shelf temperature reaches the desired set point, turn the vacuum pump off, release the vacuum, and open the chamber door. Place the frozen samples on the shelf, close the door, and turn the vacuum on.
5. Shelf set point temperature and vacuum set point can be changed at any time during the manual freeze dry process.
6. To stop, press MANUAL, then Stop. This will turn off the refrigeration system and heater.

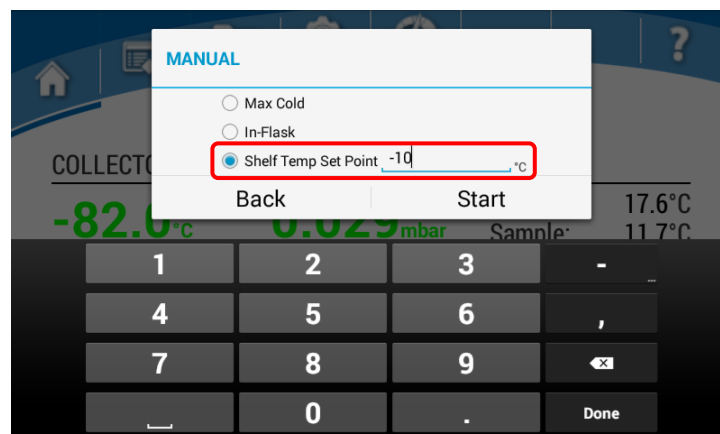
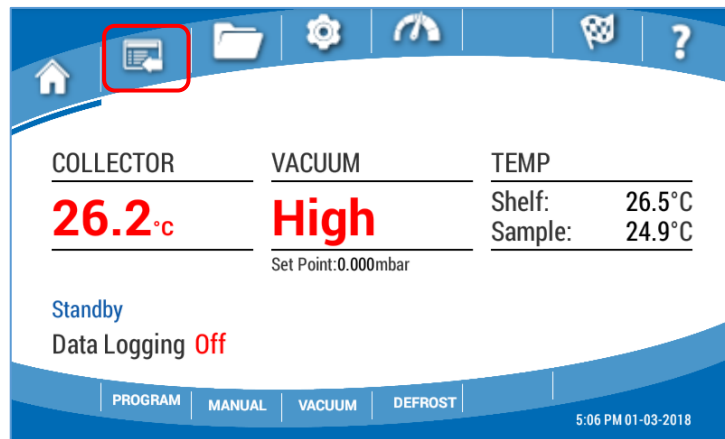

Chapter 5: Using Your Freeze Dryer

Manual Mode with Unfrozen Samples

1. Place unfrozen samples on the shelf and close the door. The sample probe can be placed in the sample if desired.
2. Start the refrigeration system by pressing MANUAL, then select Max Cold or enter a Shelf Temp Set Point (depending on the desired shelf temperature), then press Start.
3. Make sure the vacuum is turned OFF.



THE VACUUM SHOULD ALWAYS BE TURNED OFF WHILE USING THE SHELVES TO FREEZE SAMPLES

4. The shelf will cool to the entered set point value (or approx. -75°C in Max Cold mode).

Note: With the system starting at room temperature, it will take approximately 6 hours to freeze a 2 liter tray of water in Max Cold mode.
5. When the sample is frozen, change the shelf set point to the desired temperature.
6. Turn on vacuum.
7. Shelf set point temperature and vacuum set point can be changed at any time during the manual freeze dry process.

Program Mode with Pre-Frozen Samples

The shelf should be pre-cooled to the desired temperature before placing pre-frozen sample on it for freeze drying. Pre-cooling the shelf can be done with either the Manual or Program mode (Manual mode has been detailed above). You can access the Programs screen from two different buttons, both lead to the same location:

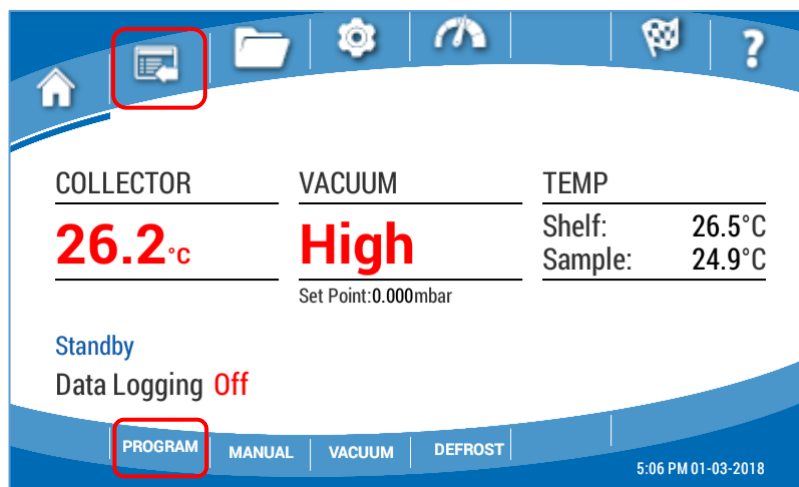

1. Go to the Programs screen.
2. Select a program from the saved programs list, or create a new program.
3. With the desired program selected from the list, press the START button.
4. The refrigeration system will start.
5. When the collector temperature reaches -80°C and the shelf temperature reaches the desired set point of segment 1, turn off the vacuum pump and release the vacuum. Place the frozen samples on the shelf. Close the door and turn the vacuum on.

Program Mode with Unfrozen Samples

1. Place unfrozen samples on the shelf and close the door. The sample probe can be placed in the sample if desired.
2. Go to the Programs screen.
3. Select a program from the saved programs list, or create a new program. The first step of the selected program (or multiple steps if desired) must have the vacuum turned OFF while the sample is pre-freezing.

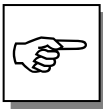

THE VACUUM SHOULD ALWAYS BE TURNED OFF WHILE USING THE SHELVES TO FREEZE SAMPLES

4. With the desired program selected from the list, press the START button.
5. The refrigeration system will start.
6. The program should contain all the necessary steps to take the sample through the pre-freezing, primary drying, and secondary drying processes.

Stopping the Freeze Dry Cycle

Manual Mode

1. Go to the Home screen, press MANUAL, then Stop.
2. Turn OFF the vacuum pump.
3. Position the “Vac Release” valve to OPEN (or open one of the sample valves on the left side of the unit).
4. Allow the vacuum to bleed to atmospheric pressure, then open the door and remove the samples.
5. Defrost the ice, drain the collector pan, and dry.

Program Mode

1. If operating in program mode, the “Program Complete” alert will be displayed on the touch screen at the end of the last programmed step. After the “Program Complete” alert has been presented, the unit will continue to run in Manual mode until turned off by the user (shelf set point temperature and vacuum set point will hold the settings from the last program step).

Chapter 5: Using Your Freeze Dryer

2. To stop a program (at any time) go to the Programs screen, select (highlight) the program that is currently running, press Stop. This will turn OFF the refrigeration system & vacuum pump.
3. Position the “Vac Release” valve to OPEN (or open one of the sample valves on the left side of the unit).
4. Allow the vacuum to bleed to atmospheric pressure, then open the door and remove the samples.
5. Defrost the ice, drain the collector pan and dry.

Freeze Drying Using Sample Valves (In-Flask Mode)

The In-Flask mode is used to freeze dry pre-frozen samples when using ONLY the sample valves on the left side of the unit. There is no shelf temperature control in this mode. The refrigeration system will only cool the collector. The following procedure should be followed when using the sample valves to freeze dry:

1. Go to the Home screen and press MANUAL, then select In-Flask.
2. Once the collector temperature is less than -80°C and vacuum is less than 0.133 mbar, connect a pre-frozen sample to a sample valve on the left side of the cabinet using an adapter. Turn the plastic valve knob to the “VACUUM” position to open the valve. The bevel on the knob should be positioned toward the sample port to apply vacuum to the sample.
3. Before adding another sample, allow system vacuum to return to the vacuum set point. Any combination of valves and sample sizes may be utilized at one time provided that the system vacuum and collector temperature remain sufficiently low to prevent melting of the frozen sample.
4. When all the frost has disappeared from the outer surface of the sample container and no cold spots can be detected by handling the container, primary drying is nearly complete. To be certain of low final moisture content, dry the sample for several hours past this point.

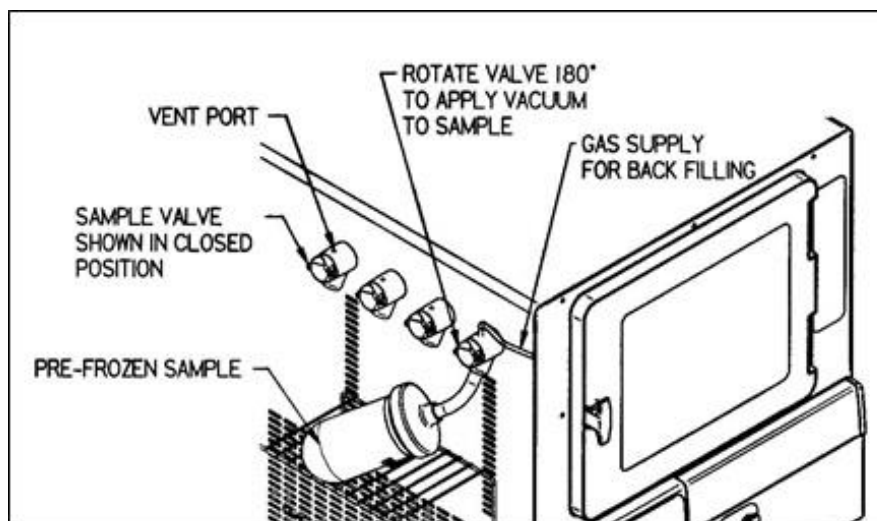

5. To remove a container after freeze drying is complete, turn the plastic knob on the valve to the “VENT” position, which closes the valve and vents the container. Should backfilling with an inert gas be required, connect the gas supply line to the vent port on the valve before turning the plastic knob on the valve to vent position. The sample container may now be removed. In the vent position the bevel on the valve knob should point away from the sample port.
6. Ampules may be flame sealed while connected to a valve by using a sealing torch. Care must be taken not to burn the valve. An insulation material placed between the valve and the torch is recommended.

Stoppering Vials

The stoppering operation (when desired) is performed after the freeze dry process is complete and before breaking vacuum. To seal vials, move the Stoppering control toward the “LOWER” position. This action allows the diaphragm above the stoppering platen to inflate causing the platen to lower. The platen will lower until it contacts the vials on the shelf. The rubber stoppers will be pressed into the vials. Monitor the stoppering process by looking through the chamber door.

When all of the vials appear to be stoppered, move the Stoppering Control to the “RAISE” position. This opens the diaphragm to the vacuum pump, which deflates the diaphragm. Opening the Vacuum Release Control also deflates the stoppering diaphragm. The Stoppering Control should be left in the “RAISE” position when not stoppering. The stoppering mechanism is equipped with anti-tilt switch which will stop the platen from lowering if it tilts more than 4°. If this happens return the stoppering control valve to the “RAISE” position. This will deflate the diaphragm and allow the platen to return to the raised position. Determine the cause of the tilt condition before proceeding.

Vacuum Break/Backfilling

To open the chamber door, the vacuum must be released. To release the vacuum, move the Vacuum Release Control to the “OPEN” position and turn off the vacuum pump by pressing VACUUM, then Stop. The vacuum can also be released more quickly by opening one of the sample valves on the left side of the unit. Air enters the vacuum chamber through the Back Fill Port. When the sound of air through the Back Fill Port is no longer audible, the chamber door is ready to open.

To backfill the chamber with a gas, connect a cylinder of the desired gas to the Back Fill Port. The port will accept 1/8" tubing. The bottle must be equipped with a regulator set to 15 psi maximum. The gas can be metered with the Vacuum Release Control and chamber pressure monitored with the freeze dryer vacuum gauge. Allow the vacuum pump to run for a few minutes while the gas enters to permit the back fill gas to surround the freeze dried sample. When the vacuum pump is turned off, air will enter the system through the vacuum break valve located between the vacuum pump and the collector chamber.

Chapter 5: Using Your Freeze Dryer

Defrosting

After the freeze dry process is complete the ice that has accumulated on the collector coil must be removed. The Triad Freeze Dry System is equipped with a rapid defrost feature.

The following procedure should be followed when defrosting the collector coil:

1. Press the DEFROST button on the Home screen. The defrost indicator above that button will illuminate. Allow unit to operate in this condition until all condensate is defrosted from the collector coil. Turn the system off by pressing DEFROST, then Stop. The defrost function will turn off automatically if the collector temperature reaches +60°C or if defrost has been running for 2 hours.
2. Place the drain hose in a suitable container to collect the condensation. Remove the drain plug from the drain hose.
3. Replace drain plug and remove drain pan to dispose of the ice and wipe dry.
4. Wipe any excess liquid from inside of vacuum chamber, replace drain pan.



Utilization of acid requires immediate cleaning and neutralization after defrost or physical damage to the collector chamber and coil will result.

Do not attempt to chip ice from the collector coil as damage may occur.

Never attempt to start the vacuum pump when there is liquid in the collector chamber. This could result in damage to the vacuum pump.

Alerts

A number of events may occur during a lyophilization procedure that will cause an alert to be displayed on the Freeze Dryer touch screen. An audible alarm (beeper) will also be sounded that will automatically be muted after one minute.

The specific alert type can be identified by observing the message box on the display. The alert message box and audible alarm can be dismissed by pressing the “Back” button on the alert message box. The following conditions will initiate an alert.

Power Fail

If a power failure occurs during a Freeze Dry process, the vacuum control valve will allow air to bleed into the Freeze Dryer System. If the failure is of a short duration and the collector does not warm up above -30°C, when power is restored the Freeze Dryer will restart and resume operation of the refrigeration and vacuum systems. If the power failure lasts for a longer duration and the collector warms above safe limits, when the power is restored, the Freeze Dryer will not

automatically restart. This prevents melted sample from being drawn into the collector and prevents liquid from being drawn into the vacuum pump. When power is restored, the POWER FAIL alert message will be displayed on the touch screen and the audible alarm will sound.

Line Voltage Range

If the voltage supplied to the Freeze Dryer varies beyond allowable limits, the LINE VOLTAGE RANGE alert will be activated. The high and low alarm points are preset at the factory to correspond to the normal allowable voltage variations based on the nominal voltage specified for the freeze dryer. Some models may be operated outside the normal voltage limits (see *Appendix C*). If necessary, the high and low LINE VOLTAGE OFFSETS may be adjusted from the Settings / Maintenance screen.

Collector Temp

After the collector temperature has cooled to below -40°C , an alert will be activated if the collector temperature rises above -40°C for more than 5 minutes.

Service Vacuum Pump

The vacuum pump normally plugs into the vacuum pump electrical receptacle on the back of the Freeze Dryer. When the Freeze Dryer has accumulated a total of 1000 operating hours, an alert will be activated. It may be necessary to service the vacuum pump more frequently than every 1000 hours depending on the operation of the Freeze Dryer. **The pump oil should be regularly monitored to verify that it is clean.** The “Set hours between oil change” can be reprogrammed from the Settings / Maintenance screen for any value from 0 to 9999 hours.

Vacuum Leak

If the vacuum level in the freeze dryer has not reached at least 5 mbar within 30 minutes of starting the vacuum, an alert will be activated and the vacuum pump will be turned off (if it is plugged into the Freeze Dryer vacuum pump outlet).

System Temp Variation

Once the system temperature has stabilized (held set point temperature within $\pm 2^{\circ}\text{C}$ for 20 minutes), if the manual set point temperature or program hold temperature varies more than $\pm 2^{\circ}\text{C}$ from the set point (as measured by the system temperature sensor), the “System Temp Variation” alert will be displayed.

Vacuum Variation

Once the system vacuum has stabilized at a point where it changes less than 0.020 mbar in 5 minutes, if the vacuum changes more than 0.500 mbar, the “Vacuum Variation” alert will be displayed.

Vacuum Set Point

If the system is unable to achieve the vacuum set point (during Manual or Program mode), an alert will be activated. This alert will be activated if the vacuum level is not within 0.500 mbar of the vacuum set point in 20 minutes.

Chapter 5: Using Your Freeze Dryer

Shelf Temp Set Point

If during a Ramp segment the shelf temperature stabilizes without reaching the Shelf Temp Set Point, the control will automatically enter the next Hold segment and the “Shelf Temp Set Point” alert will be displayed.

Platen Tilt

If the stoppering platen tilts more than 4° while stoppering, the platen will stop. If this happens return the stoppering control valve to the “RAISE” position. This will deflate the diaphragm and allow the platen to return to the raised position.

Determine the cause of the tilt condition before proceeding.

Program Complete

This alert will be activated when the last step of a running program has been completed.

Status Email Messages

If this option has been turned on, the selected email addresses will receive STATUS alert messages containing the current operating parameters of the Freeze Dryer. Status alert messages will not be displayed on the touch screen. The Freeze Dryer can be configured to send email status alert messages from the Settings / Alerts / Select Alerts screen.

Export a Data Log File

Data Log Files can be copied (exported) to a USB flash drive via the USB port on the left side of the Freeze Dryer. The file will be exported as a “comma separated values” file (.csv file extension), which can be easily opened with a spreadsheet application program for data analysis and graphing. To export a file:

1. Insert USB flash drive into the Freeze Dryer USB port
2. Go to Data Logging screen
3. Select the file that you want to export by pressing the Data Log File name
4. Press the Export button

Downloading Data Log Files via Ethernet

Data log files that are stored in the Freeze Dryer can be downloaded via an Ethernet connection. In order for this to be possible, a working Ethernet connection must first be established. The following steps must be completed:

1. An Ethernet cable must be connected to the Ethernet port on the back of the Freeze Dryer and to a Local Area Network (LAN) with working internet service.
2. The proper settings must be entered into the Settings>Network screen to establish a valid network connection (see description of Network screen in Chapter 4).
3. Write down the “IP Address” shown on the Settings>Network screen of the Freeze Dryer (this number will be used in Step 5)

4. Open an internet browser of your choice from a computer that is connected to your LAN.
5. Type the following into the address bar at the top of the browser screen: **http://“IP Address”:8080** where “IP Address” represents the number written down from the Settings>Network screen in Step 3 (example = **http://10.10.9.117:8080**).

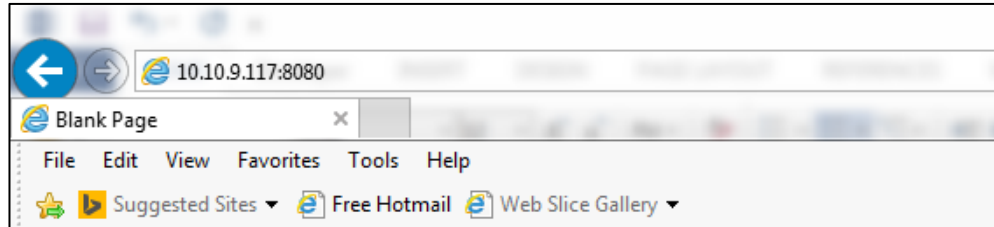

6. The following webpage will appear with a list of all the Data Log files that are stored on the Freeze Dryer.

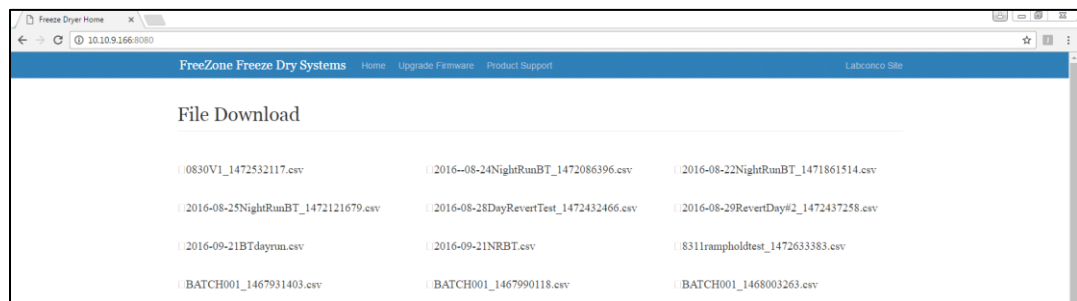

7. Single click on a file name from the list to download the file.
8. Single click on the downloaded file to open the file in Excel.

Copy a Program

If you wish to duplicate a program or quickly create a program that is similar to an existing program, you can use the copy program function. The new program file created by the copy function will be stored on the Freeze Dryer. To copy a program:

1. Go to Programs screen
2. Select a program from the list by pressing the program name
3. Press the COPY button
4. Edit program name if desired (the default program name will be “*program name_copy*”)

CHAPTER 6

MAINTAINING YOUR FREEZE DRYER

Service Safety Precautions



- Always ensure that only authorized technicians service the refrigeration, vacuum and electrical systems.
- If performing any electrical maintenance, always disconnect the power at the main disconnect.
- If the refrigeration system must be operated with access panels removed (for diagnostic purposes only), stay clear of moving fan blade.
- Always practice team lifting when moving heavy equipment.
- After servicing, verify that all access panels or covers are in place before resuming normal operation of the equipment.

Routine Maintenance Schedule

Under normal operation, the Freeze Dryer requires little maintenance. The following maintenance schedule is recommended:

As needed:

1. The user has the responsibility for carrying out appropriate decontamination if hazardous material is spilled on or inside the equipment. This may be done by wiping the contaminated surfaces with a soft cloth dampened with alcohol. Alcohol may craze the acrylic door. Before using any cleaning or decontamination method except those recommended by Labconco, users should check with Labconco to determine that the proposed method will not damage the equipment.
2. Clean up all spills; remove liquids from the chamber.
3. Clean door and gasket using soft cloth, sponge or chamois and a mild, non-abrasive soap or detergent.

4. Check oil level of the vacuum pump. It should be between MIN and MAX. If the oil level is less than an inch (25.4 mm) above MIN, add oil to proper level.
5. If oil shows cloudiness, particles or discoloration, drain the pump and replace with fresh oil.
6. The use of acids requires immediate cleaning and neutralization after a run or physical damage will result.
7. When freeze drying biological substances, it may be necessary to decontaminate the system. A surface decontaminant should be used to clean the accessible surfaces.



The use of ethylene oxide is not recommended because of its hazardous and corrosive nature. Contact Labconco for additional information.

Monthly:

1. The rubber components on the freeze dry system may eventually deteriorate and require replacement. The effective life of rubber parts depends upon both their usage and the surrounding environment. Check all rubber hoses and gaskets and replace any that show signs of hardening, permanent set or deterioration.
2. Using a soft cloth, sponge or chamois and a mild, non-abrasive soap or detergent, clean the acrylic door.
3. Using a soft cloth, sponge, or chamois and a mild, non-abrasive soap or detergent, clean the exterior surfaces of the cabinet. Liquid spray cleaners and polishes may be used on the exterior surfaces. Do not use solvents to remove stains from the exterior surfaces as they may damage the finish.

Annually:

1. Every 12 months, or more often if the freeze dry system is operated in a dusty environment, the refrigeration system condenser should be cleaned. Using a vacuum cleaner with brush attachment, clean the condenser to ensure proper airflow for peak performance.

CHAPTER 7

TROUBLESHOOTING

Refer to the following if your Freeze Dryer fails to operate properly. If the suggested corrective actions do not solve your problem, contact Labconco for additional assistance.

Vacuum System Performance

FreeZone® Triad™ Freeze Dry Systems that are clean and dry and without samples attached should reach a vacuum of 0.133 mbar within 30 minutes and should achieve an ultimate vacuum of 0.040 mbar within 18 hours when the refrigeration is operating. If the freeze dry system does not obtain a satisfactory vacuum, perform the following maintenance tests.

Vacuum Pump

First make sure that the vacuum pump operates. If it fails to operate, check the electrical connections of the Freeze Dryer to the power source and then check the electrical connection of the vacuum pump to the Freeze Dryer. If the vacuum pump has a power switch, make sure that it is turned on. **Note: If the vacuum pump is plugged directly into a wall outlet for troubleshooting purposes, the vacuum START button must be initiated on the display screen. If the vacuum START button is not initiated the vacuum vent valve will remain open and the vacuum reading will remain on HIGH.** If the vacuum is not adequate when the vacuum pump is operating, proceed with the following steps:

1. Check the oil and ensure it is clear and clean. If the oil looks cloudy or has any particulates, replace the pump oil. Sometimes it may be necessary to flush the pump with clean oil several times. To flush the pump, run the pump 5 to 10 minutes to allow the oil to warm up. Drain the oil and refill with clean oil. Repeat as necessary.
2. Check the oil level in the pump. Ensure it is filled to the correct level.
3. Check vacuum hose connections from the pump to the Freeze Dryer and try running the unit.

If vacuum problems continue, consider obtaining a second vacuum gauge capable of reading a vacuum of 0.010 mbar. It is often useful in determining if the vacuum pump is operating properly and the vacuum sensor reading is accurate.

4. Isolate the pump by disconnecting the vacuum hose from the Freeze Dryer. Deadhead the pump by inserting the vacuum sensor from a secondary vacuum gauge into the end of the vacuum hose and observe the vacuum reading obtained. Confirm that the pump is capable of achieving an ultimate vacuum less than 0.010 mbar or approximately 10 microns. If an inadequate vacuum reading is obtained, the pump has most likely failed and may need to be replaced or rebuilt.

Gaskets, Tubing, Connections, Sample Valves

1. Check all sample valves on the side of the cabinet and ensure all valves are closed or in the vent position.
2. Check all vacuum tubing for signs of deterioration or cracking.
3. Check all connections and make sure they are secure and leak tight.
4. Check the freeze dry system door gasket for indentations cracks or tears. Clean gaskets using a soft, lint free cloth or paper towel.
5. The freeze dry system chamber and collector must be dry.
6. When checking the sample valves, pull as much vacuum as possible. If a vacuum indication is displayed, wiggle or rotate the valves and watch the gauge for any fluctuation. Fluctuations can show a potential vacuum leak. If the valve seems to be in good condition, remove the valve and apply a thin coat of vacuum grease to the stem and the outside sealing surface of the valve body, and reinstall the valve. If the valve still seems to be the source of the problem, remove the valve and stopper the hole with a rubber stopper. Continue checking the other valves.

Sample Valve Installation

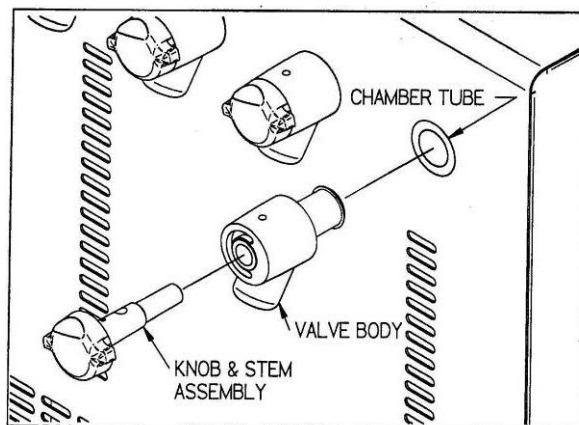

Door Adjustment

The following adjustments can be made if the door is not sealing properly when vacuum is applied.

1. The latch can be adjusted to increase the force between the door gasket and chamber sealing surface.
 - a. Open the door.
 - b. Using two ½" wrenches, loosen the nuts securing the latch pawl.
 - c. Move the latch pawl towards the door to tighten the latch.
 - d. Tighten the nuts.
2. The door hinges can be adjusted to move the door in towards the chamber sealing surface.
 - a. Removing the four screws that attach the back panel to the side panel.
 - b. Close the vacuum release. Remove the knobs from the two valves on the front.
 - c. Remove the lower front panel.
 - d. Remove the one screw on the left side of the control panel.
 - e. Remove the three screws attaching the right panel to the base and remove the panel.
 - f. Turn on the vacuum pump. After the vacuum level reaches approximately 5mbar, loosen the six screws on the door hinges. ***Do not remove the screws.***
 - g. Once the vacuum level reaches approximately 1mbar, tighten the six screws.

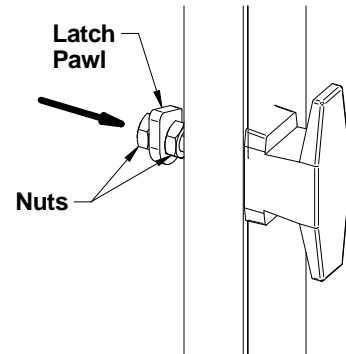

Refrigeration Module Performance

In Max Cold mode under a no-load condition and an ambient temperature of 20°C, the freeze dry system refrigeration system can achieve a shelf temperature of -75°C or lower within 4 hours.

If any repairs are required on the refrigeration module, please call Labconco. Repairs should only be undertaken by a competent refrigeration technician or through an authorized Labconco service agency.

Filling the Fluid System

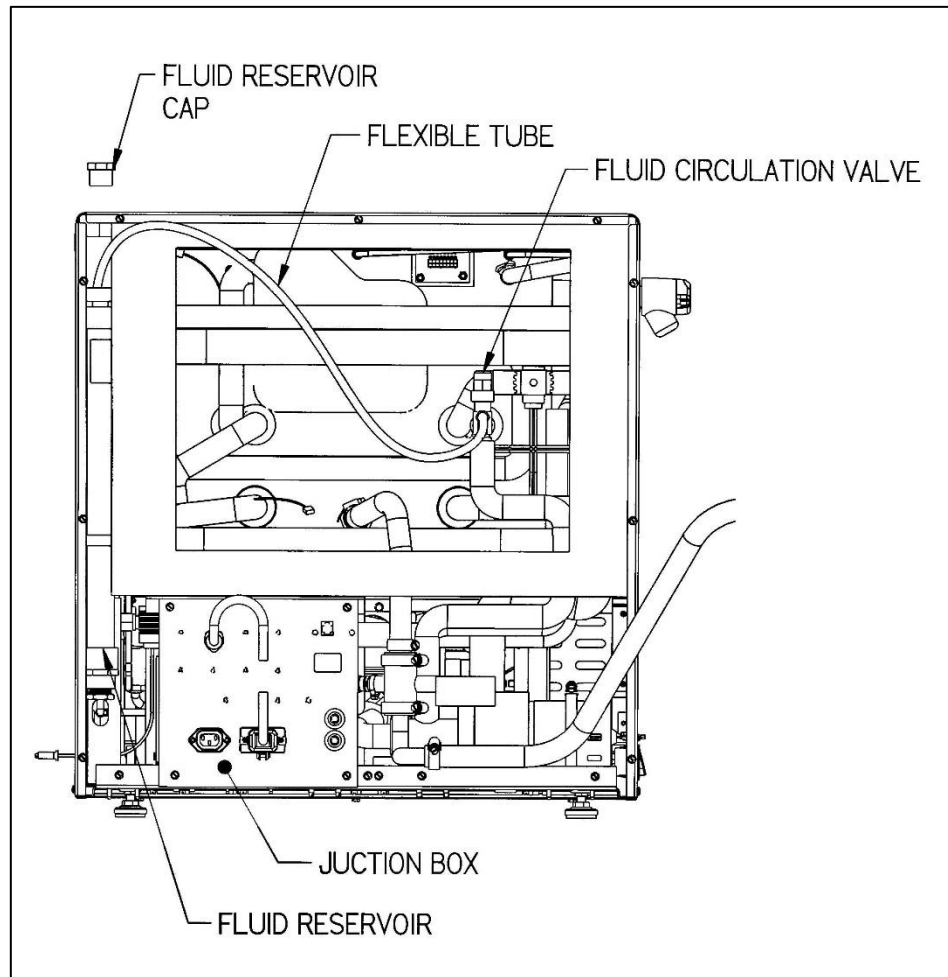

1. Disconnect power cord from supply outlet.
2. Remove the rear cover to expose the marked back foam insulation. Cut through the foam along the marked lines and remove center cutout.
3. Remove the insulation and both caps from the fluid circulation valve.
4. Attach a flexible tube to the exposed port (service port). The port is 3/8" x 45° male flare.
5. Remove the fluid reservoir cap and place the opposite end of the tubing into the fluid reservoir.
6. Fill the reservoir slowly allowing the fluid to drain through the system. When the system appears full, prepare to start the circulation pump.
7. Open the fluid circulation valve by completely “down-seating” (turn top valve stem completely clockwise) to direct fluid to by-pass through tubing to fluid reservoir.

8. Connect the unit to the proper power source. Activate the pump from the display screen (Home screen) by selecting MANUAL, entering 24°C (in Shelf Temp Set Point entry field), and pressing Start. This will start the heat transfer fluid pump and also the refrigeration system. The fluid system will circulate with the fluid going through the add-on tubing, purging itself of air. Add fluid when needed to keep fluid in the reservoir. After the fluid stream is established, tilt the entire freeze dry system up and down. Observe the fluid stream and repeat the tilt procedure if it is not free of bubbles. Fill reservoir to level indicated by the label.
9. Turn the pump and refrigeration system OFF by pressing MANUAL, then Stop. Disconnect power cord from supply outlet.
10. Close “up-seat” fluid circulation valve (turn valve stem completely counter-clockwise, closing the fluid/tubing by-pass).
11. Remove the tubing. Replace the caps on the valve and replace insulation and covers. Replace the cap on the tank.
12. Replace insulation and seal air tight. Replace rear cover.

Heat Transfer Fluid Precautions

The fluid’s name and manufacturer are:

Name: Lexol 542
Manufacturer: Santa Barbara Chemical Co.
927 Indio Muerto
Santa Barbara, CA 93140
805-963-7793



The fluid used for heat transfer in this system is combustible and hazardous. Leaks and spills should be attended to immediately or serious injury could occur.

Handling and Storage Precautions – Dirty Solvent: Store in accordance with all applicable regulations. Tighten caps and store in a cool area.

Precautions if Material is Released or Spilled: Spills should be contained immediately. Spills may be soaked up with absorbent materials, placed in closed containers, labeled, stored and disposed of properly. Persons performing this work should wear adequate personal protective equipment and clothing.

Disposal of Non-Recyclable Solvents: Dispose of in accordance with all federal, state, and local health and pollution regulations. Follow same guidelines as when disposing kerosene.

Heat Transfer Fluid First Aid Procedures

Eye Contact: Immediately flush eyes with fresh water for at least 15 minutes. If irritation persists, get medical attention.

Skin Contact: Wash contaminated areas with soap and water. Remove contaminated clothing and footwear. Wash clothing before reuse. Discard footwear which cannot be decontaminated. Medical attention may be required.

Inhalation: Remove patient to fresh air. If breathing stops, give artificial respiration. Get medical attention immediately, if required.

Ingestion: Get medical attention immediately. Do not induce vomiting.

APPENDIX A

FREEZE DRYER COMPONENTS

The following pages list components that are available for your Freeze Dryer. The parts shown are the most common replacement parts. If other parts are required, contact Product Service.

Appendix A: Freeze Dryer Components

Item	Part No.	Qty.	Description
1	7591806	2	Compressor 230V – 50 Hz (Not Shown)
	7591807		Compressor 230V – 60 Hz (Not Shown)
2	7501902	1	Lexsol Pump 230V
3	7365401	1	Heater 230V
4	7211100	1	Door Gasket
5	7210900	1	Chamber Door Assembly (includes Gasket)
6	7365800	2	Temperature Sensor – Sample
7	7515302	1	Temperature Sensor – Collector (Not Shown)
8	7337600	1	Control Assembly
9	7840000	1 Gal.	Heat Transfer Fluid (Not Shown)
10	1338002	1	Power Cord 230V 60Hz US (Not Shown)
	1332601		Power Cord 230V 60Hz Saudi (Not Shown)
	1336500		Power Cord 230V 50Hz EU (Not Shown)
	1332701		Power Cord 230V 50Hz China (Not Shown)
	1332601		Power Cord 230V 50Hz UK (Not Shown)
	1345701		Power Cord 230V 50Hz India (Not Shown)
	11		7373436
12	1488800	2	Hose Clamp
13	7343900	1	Bladder, Stoppering
14	7508600	4	Valve Knob
15	7505600	4	Valve Body

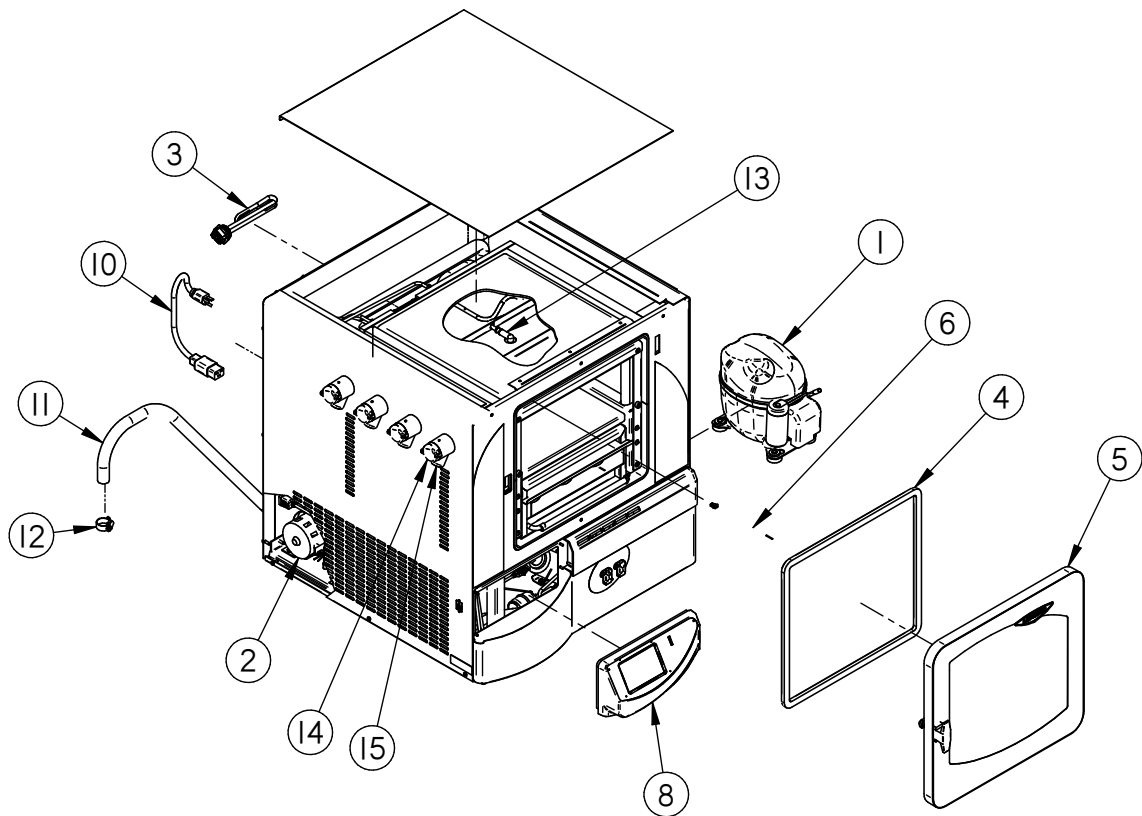

APPENDIX B

FREEZE DRYER DIMENSIONS

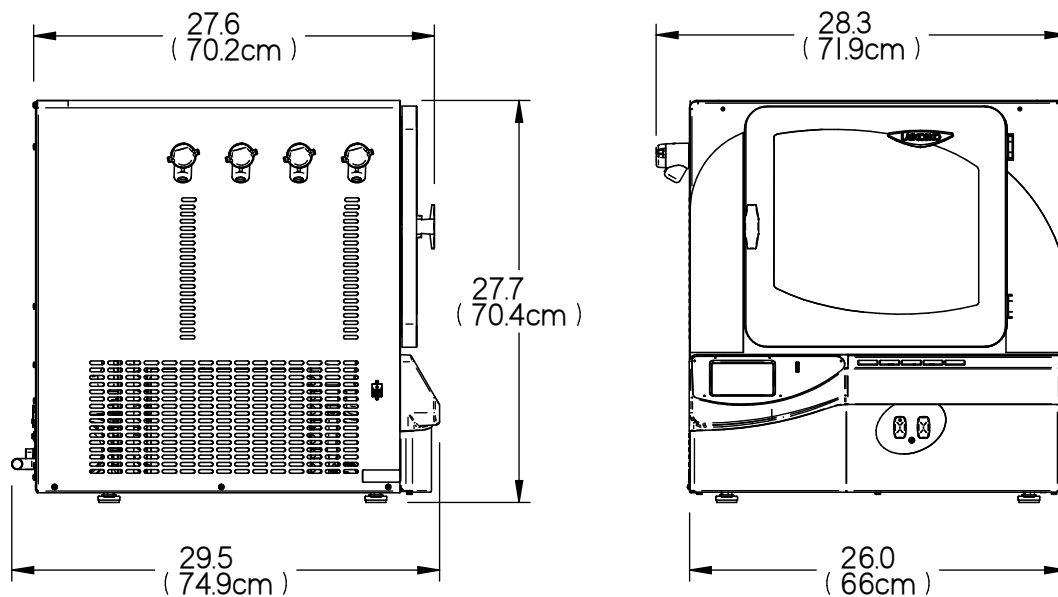

Serum Bottle Capacity of the Triad Freeze Dry System

Size	Labconco No (100 pcs.)	Shelf Capacity
2 ml	7575010	400
3 ml	7575210	441
5 ml	7573010	233
10 ml	7573210	196
20 ml	7573410	121
30 ml	7573610	86
50 ml	7573810	64
100 ml	7574010	42
125 ml	7574210	36

APPENDIX C

FREEZE DRYER

SPECIFICATIONS

This Appendix contains technical information about the Freeze Dryer including electrical specifications and operating conditions.

Electrical Specifications

Catalog #	Description	Voltage		Frequency	Amps
		Nominal	Operating Range	(Hz)	Max. with Vacuum Pump
794001010 794001015	Triad Freeze Dryer	230V	187-253	60	12
794001030 794001040 794001050 794001070	Triad Freeze Dryer	230V	198-253	50	12

Environmental Conditions

- Indoor use only.
- Ambient temperature range: 41° to 104°F (5° to 40°C).
- Maximum relative humidity: 80% for temperatures up to 88°F (31°C), decreasing linearly to 50% relative humidity at 104°F (40°C).
- Main supply voltage fluctuations not to exceed $\pm 10\%$ of the nominal voltage.
- Transient overvoltages according to Installation Categories II (Overvoltage Categories per IEC 1010). Temporary voltage spikes on the AC input line that may be as high as 1500V for 115V models and 2500V for 230V models are allowed.
- Used in an environment of Pollution degrees 2 (i.e., where normally only non-conductive atmospheres are present). Occasionally, however, a temporary conductivity caused by condensation must be expected, in accordance with IEC 664.

APPENDIX D

FREEZE DRYER ACCESSORIES

Labconco offers a full line of accessories to enhance your Freeze Dryer's operation and usability. For a complete list of these accessories, please consult our website at www.labconco.com.