

# DIAPHRAGM VACUUM PUMP LABOPORT® N 840 G



## Technical features

- 100% oil-free transfer – thereby pure transferring, evacuation and compression of gases
- High level of vapor and condensate compatibility
- Ideal for extremely aggressive/corrosive gases and vapors
- ATEX compliant according to  $\text{Ex}$  II 2/-G IIB+H2 T3 internal atmosphere only
- Integrated gas ballast valve
- Expandable: Separators and/or condensers can be purchased individually at any time and easily fitted, enabling users to build their own customized vacuum system
- 3-color status display for in operation / stand-by / error
- Integrated rotational speed control
- Environmentally friendly
- Start against ultimate vacuum of the pump

## Technical data

Flow rate [m <sup>3</sup> /h] at atm. pressure	2.04
Flow rate [l/min] at atm. pressure	34
Ultimate vacuum [mbar abs.]	6.0
Operating pressure [bar]	0.1
Voltage [V]	100 – 240
Frequencies [Hz]	50/60
Protection class	IP30
Power P <sub>1</sub> [W]	100
Operating current [A]	0.6 (100 V AC) 1.0 (240 V AC)
With thermal switch and power fuse	

## MATERIALS

Pump head	TFM™ PTFE
Diaphragm	PTFE-coated
Valves	FFPM

## OTHER DATA

Weight [kg]	11.3
Hose connections	ID 9.5 – 8, PVDF
Dimensions W x H x D [mm]	177 x 240 x 289
Permissible media and ambient temperature [°C]	+5 to +40

## ACCESSORIES AND SPARE PARTS

ACCESSORIES AND SPARE PARTS	ID
Spare parts kit	317436
Hose connector	317278
Key for hose connector*	316279
Silencer*	322528

\*Part of the scope of delivery

## Dimensions

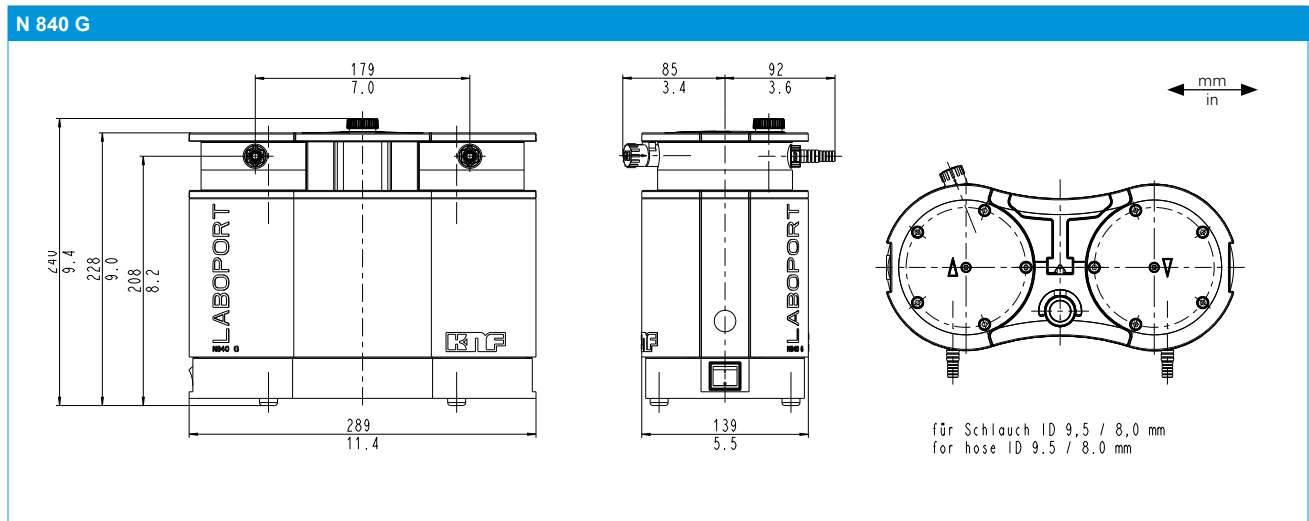

## Performance Characteristics

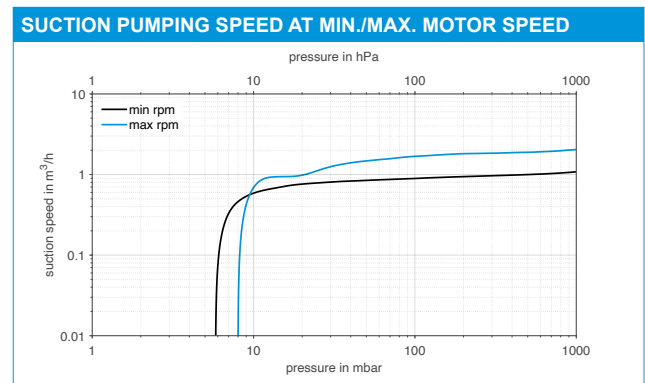
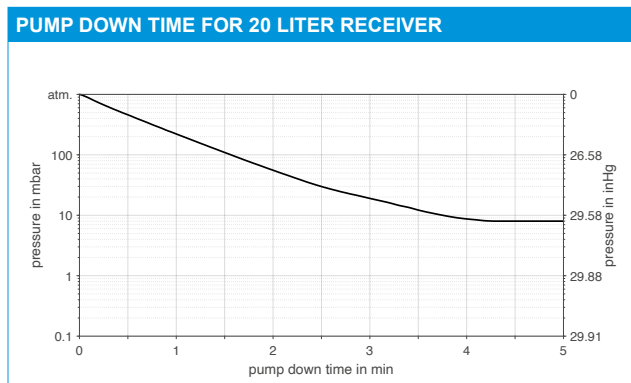

## Modular expandable – from basic pump to system



CONVERSION KITS	ID
Conversion kit N 840 G in SR 840 G	339205/000000
Conversion kit N 840 G in SH 840 G	339201/000000
Conversion kit N 840 G in SC 840 G	337238/000000