

OPERATING MANUAL

Shaking Water Baths

SW22

SW23



JULABO USA, Inc.
884 Marcon Boulevard
Allentown, PA 18109
Phone: +1(610) 231-0250
Fax: +1(610) 231-0260
info@julabo.us
www.julabo.us

Congratulations!

You have made an excellent choice.

JULABO thanks you for the trust you have placed in us.

This operating manual has been designed to help you gain an understanding of the operation and possible applications of our circulators. For optimal utilization of all functions, we recommend that you thoroughly study this manual prior to beginning operation.

Unpacking and inspecting

Unpack the shaking water bath and accessories and inspect them for possible transport damage. Damage should be reported to the responsible carrier, railway, or postal authority, and a damage report should be requested. These instructions must be followed fully for us to guarantee our full support of your claim for protecting against loss from concealed damage. The form required for filing such a claim will be provided by the carrier.

TABLE OF CONTENTS

ABRIDGED MANUAL - SW22 / SW23	5
OPERATING MANUAL.....	7
1. INTENDED USE	7
1.1. Description	7
2. OPERATOR RESPONSIBILITY – SAFETY INSTRUCTIONS.....	7
2.1. Disposal	9
2.2. Technical data.....	10
OPERATING INSTRUCTIONS.....	12
3. OPERATING CONTROLS AND FUNCTIONAL ELEMENTS	12
4. SAFETY NOTES FOR THE USER.....	14
4.1. Explanation of safety notes	14
4.2. Explanation of other notes.....	14
4.3. Safety instructions	14
5. PREPARATIONS.....	16
5.1. Installation	16
5.2. Bath liquid	17
5.3. Filling / Draining.....	18
5.4. Maintaining a constant water level / Counter cooling	19
5.5. Accessories.....	20
6. OPERATING PROCEDURES.....	21
6.1. Power connection.....	21
7. SWITCHING ON.....	21
7.1. Setting the temperature.....	22
7.2. Warning functions or temperature limit.....	22
7.3. Adjustment of the shaking frequency	24
7.4. Electronic timer.....	25
8. MENU FUNCTIONS	26
8.1. Shaking operation On/Off.....	26
8.2. Circulator pump on/off.....	27
8.3. Temperature indication in °C or °F	27
8.4. ATC - Absolute Temperature Calibration	28
8.5. Setup for remote control.....	29
8.6. Adjusting interface parameters.....	30
8.7. Evaluation of the temperature limits	31
9. SAFETY INSTALLATION (WITH SHUTDOWN FUNCTION)	31
10. TROUBLESHOOTING GUIDE / ERROR MESSAGES.....	32

10.1. Acoustical signals and their differentiation	34
11. ELECTRICAL CONNECTION.....	35
12. REMOTE CONTROL.....	36
12.1. Communication with a PC or a superordinated data system.....	36
12.2. List of commands.....	37
12.3. Status messages.....	38
12.4. Error messages.....	38
13. CLEANING / REPAIRING THE UNIT	39
14. WARRANTY CONDITIONS.....	40

Abridged Manual - SW22 / SW23

① Preparations: Installation, filling and power connection see operating manual.



Minimum filling level: 7 cm (level approx. 3 cm above surface (16) for the placement of items/fixtures)

② **Mains switch (on / off)**

③ **MULTI-DISPLAY (LED)**

- | | |
|--------------------------------|--------------|
| - operating temperature value | in °C or °F, |
| - high-/ low temperature value | in °C or °F, |
| - operating time | in h:m |
| - shaking frequency | in rpm |

Each value is available on call: it may be activated, stored and indicated on the LED-display .

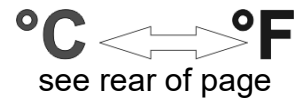
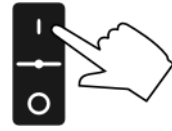





Setting operating temperature values:





④  setpoint temperature

- Press the key. The indicator light **blinks** and the value previously set appears on the MULTI-DISPLAY (LED).

If no further key is pressed the display will return to show the actual bath temperature after approx. 8 seconds.

- Use the cursor keys   to move left or right on MULTI-DISPLAY until the numeral value you wish to change is blinking.
- Use the edit keys   to increase or decrease the numeral value (1, 2, 3, ... 9).
- Press the enter key  to store the value.

Setting the warning functions and electronic timer:

- ⑤ High temperature setpoint  (see ④)
- ⑥ Low temperature setpoint  (see ④)
- ⑦ Operating time  (see ④)
- ⑧ Shaking frequency  (see ④)

Acoustical signals see rear of page.



⑨ Acoustical signals and their differentiation

Three different signals are generated by the sound generator as follows:
an alarm signal, a warning signal and a time signal

The signals can easily be recognized and differentiated, even from a good distance.

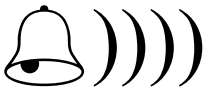

- ① The **Alarm signal** is a continuous sound signal.
Heater and circulator pump (only SW23) are completely and permanently switched off.

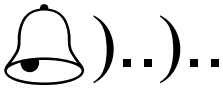

- ① The **warning signal** is issued at regular intervals (signal - pause - signal - pause).
The actual bath temperature is higher than the set overtemperature value or lower than **the set undertemperature value**

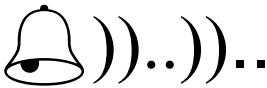

- ① The **time signal** is issued in the intervals (double signal - pause - double signal - pause).
Countdown of the adjusted operating time commences to zero, after which a time signal is issued at intervals



Menufunctions

Selecting/exiting the menu level.

- Simultaneously press the cursor key and enter .
- Use the cursor keys to select the menu option.
- Select the alternative state with the edit keys and confirm the selection with the ENTER key .
- Simultaneously press the cursor key and enter .

Temperature indication in °C or in °F

Further menu options see operating manual.

ATC - „Absolute Temperature Calibration“

Setup for remote control

Adjusting interface parameters

Circulator pump ON/OFF (only SW23)

Shaking operation ON/OFF

Evaluation of the temperature limits

Operating manual

1. Intended use

JULABO shaking water baths have been designed for temperature application to specific fluids in a bath tank. Fastened on the shaking carriage, samples contained in a sealed container can be brought to the desired temperature and simultaneously agitated.



JULABO water baths are not suitable for direct temperature control of foods, semi-luxury foods and tobacco, or pharmaceutical and medical products. Direct temperature control means unprotected contact of the object with the bath medium (bath fluid).

1.1. Description

JULABO shaking water baths of the series SW22 and SW23 are ideally suited for laboratory applications and research in the fields biology, biochemistry, pharmacology, chemistry and general medical technologies. They are likewise suited for routine laboratory tasks and long-term unattended operation. The JULABO shaking water bath SW 23 with constant bath liquid circulation, ensures a constant water temperature with a maximum deviation of ± 0.02 °C . Julabo shaking water baths feature a stainless steel bath containing heater, temperature sensor and the overtemperature protection safety element. The shaking carriage is totally removable.

The units are operated via a water protected foil keypad with integrated mains switch. Microprocessor technology enables selection and storage of different temperature values and operating times, and display of them in the LED-MULTI-DISPLAY. The self-optimizing electronic PID-control circuit automatically adjusts the heat supply to the value required by the bath.

The RS232C port permits modern process engineering without additional interface, directly on-line, from the waterbath to your application equipment.

The overtemperature protection is a safety feature with a fixed safety value of 105 °C. It functions independent of the regulator circuit.

2. Operator responsibility – Safety instructions

The products of JULABO ensure safe operation when installed, operated, and maintained according to common safety regulations. This section explains the potential dangers that may arise when operating the circulator and also specifies the most important safety precautions to preclude these dangers as far as possible.

The operator is responsible for the qualification of the personnel operating the units.

- The personnel operating the units should be regularly instructed about the dangers involved with their job activities as well as measures to avert these dangers.
- Make sure all persons tasked with operating, installing, and maintaining the unit have read and understand the safety information and operating instructions.

Operator responsibility – Safety instructions

- When using hazardous materials or materials that could become hazardous, the unit may be operated only by persons who are absolutely familiar with these materials and the unit. These persons must be fully aware of possible risks.

If you have any questions concerning the operation of your unit or the information in this manual, please contact us!

Contact:	JULABO USA, Inc. 884 Marcon Boulevard Allentown, PA 18109	Phone: +1(610) 231-0250 Fax: +1(610) 231-0260	info@julabo.us www.julabo.us
-----------------	---	--	---------------------------------

Safety recommendations for the operator

- You received a product conceived for industrial use. Nevertheless, avoid strikes to the housing, vibrations, damages to the keypad foil (keys, display) or contamination.
- Make sure the product is regularly checked for proper condition. Regularly check (at least every 2 years) the proper condition of the mandatory, warning, prohibition and safety labels.
- Take care that the mains supply features a low impedance to avoid any negative affects on the instrument being operated in the same mains.
- This unit is designed for operation in a controlled electromagnetic environment. This means that transmitting devices (e.g. cellular phones) should not be used in the immediate vicinity. Magnetic radiation may influence other units with components susceptible to magnetic fields (e.g. a monitor). We recommend to keep a minimum distance of 1 m.
- Permissible ambient temperature: max. 40 °C, min. 5 °C.
- Permissible relative air humidity: 50 % (40 °C).
- Do not store in an aggressive atmosphere. Protect from contaminations.
- Do not expose to sunlight.

Appropriate Operation

Only qualified personnel is authorized to perform configuration, installation, maintenance and repairs of the water bath.

Routine operation can also be carried out by untrained personnel who should however be instructed by trained personnel.

Use:



Insufficient ventilation may result in the formation of explosive mixtures. Only use the unit in well ventilated areas. The unit is not for use in explosive atmosphere.

JULABO water baths have been designed for temperature application to water in a bath tank.

The bath may **not** be filled with flammable materials. Fire hazard!

Only use non-acid and non corroding bath fluids.

When using hazardous materials or materials that could become hazardous, the operator must affix the enclosed safety labels (1 + 2) to the front of the unit so they are highly visible:

1		Danger area. Attention! Observe instructions. (operating manual, safety data sheet)
2		Carefully read the user information prior to beginning operation.

Particular care and attention is necessary because of the wide operating range. There are thermal dangers: Burn, scald, hot steam, hot parts and surfaces that can be touched.

	Warning: Hot surface. (The label is put on by JULABO)
---	---

2.1. Disposal

Do not dispose of the unit with household waste!

However, over the long operating period of the unit, disposal rules may change. Therefore, only qualified personnel should handle the disposal.

Valid in EU countries



See the current official journal of the European Union – WEEE directive. Directive of the European Parliament and of the Council on waste electrical and electronic equipment (WEEE).

This directive requires electrical and electronic equipment marked with a crossed-out trash can to be disposed of separately in an environmentally friendly manner.

Contact an authorized waste management company in your country. Disposal with household waste (unsorted waste) or similar collections of municipal waste is not permitted!

2.2. Technical data

		SW22	SW23
Working temperature range	°C	25 ... 99.9	25 ... 99.9
with water cooling	°C	20 ... 99.9	20 ... 99.9
MULTI-DISPLAY (LED)			
Resolution	°C	0.1	0.1
Temperature stability	K	±0.2	±0.02
Computer interface		RS232	RS232
Electronic timer	h:min	0:01 ... 9:59	0:01 ... 9:59
Heater wattage (at 230 V)	kW	2	2
Heater wattage (at 115 V)	kW	1	1
Adjustable shaking frequency	rpm	20 ... 200	20 ... 200
Shaking stroke	mm	15/25	15/25
Bath opening (W x L)	cm	50 x 30	50 x 30
Usable bath depth	cm	18	18
Filling volume	Liter	8 ... 20	8 ... 20
Dimensions W x L x H	cm	70 x 35 x 26	70 x 35 x 26
(including cover)	cm	70 x 35 x 43	70 x 35 x 43
Weight	kg	21	22
Ambient temperature	°C	5 ... 40	5 ... 40
Mains power connection	V/Hz	230 / 50/60	230 / 50/60
Current draw (at 230 V)	A	9	9
Mains power connection	V/Hz	115/60	115/60
Current draw (at 115 V)	A	9	9

All measurements have been carried out at: (DIN 12876) rated voltage and frequency, ambient temperature 20 °C; operating temperature 70 °C; bath liquid water

Safety installations according to IEC 61010-2-010:

Excess temperature protection	105 °C - fixed value
Classification according to DIN 12876-1	class I
Alarm indication	optical + audible (continuous tone)

Supplementary safety installations

High temperature warning function	optical + audible (in intervals)
Low temperature warning function	optical + audible (in intervals)
Timer	audible (in intervals)

Environmental conditions according to EN 61 010, part 1:

Use only indoor.

Altitude up to 2000 m - normal zero.

Ambient temperature: +5 ... +40 °C (for storage and transportation)

Air humidity:

Max. rel. humidity 80 % for temperatures up to +31 °C,

linear decrease down to 50 % relative humidity at a temperature of +40 °C

Max. mains fluctuation of ± 10 % are permissible.

Protection class according to EN 60 529	IP 21
The unit corresponds to Class	I
Overvoltage category	II
Pollution degree	2



Caution:

The unit is not for use in explosive environment

Standards for interference resistance according to EN 61326-1









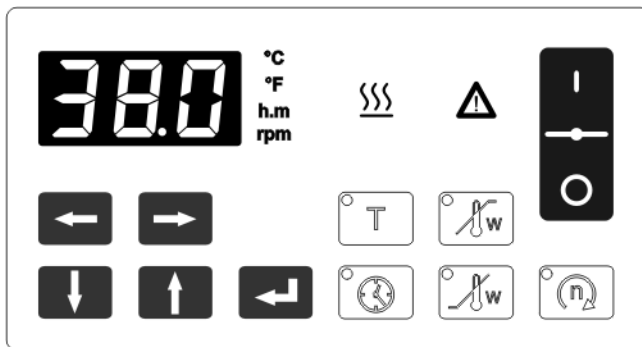



This unit is an ISM device classified in Group 1 (using high frequency for internal purposes)

Class A (industrial and commercial range).

Operating instructions

3. Operating controls and functional elements



- 1  Mains power switch, illuminated
 on
off
- 2  Working temperature
- 3  High temperature warning limit
- 4  Low temperature warning limit
- 5  Operating hours indicator key
- 6  Nominal value shaking frequency display key
- 7  Indication:
MULTI-DISPLAY (LED)
Temperature display optionally in °C or °F;
time display in h:m and shaking frequency.
The corresponding symbol will illuminate on selection.
 - Indicator light - Alarm red illuminated
 - Indicator light - Heating yellow illuminated
- 8  Cursors left/right
- 9  Edit keys (increase/decrease setting)
- 10  Enter key (store/quitting the audible signal)

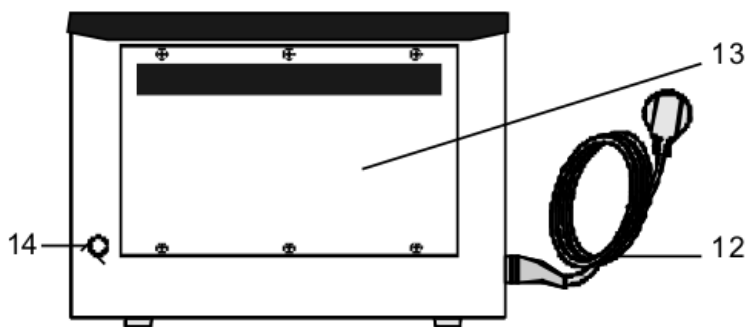

- 11 Drainage screw
- Connector for liquid level/cooling set (accessory)
- 12 Mains power cable with plug
- 13 T 10 A power supply fuses behind side cover
- 14 RS232C interface
- 15 Shaking carriage - totally removable
- 8 kg load-carrying capability
- 16 Surface for placement of items (fixtures)
- 17 Stroke bar with fastening screw
- 18 Washers

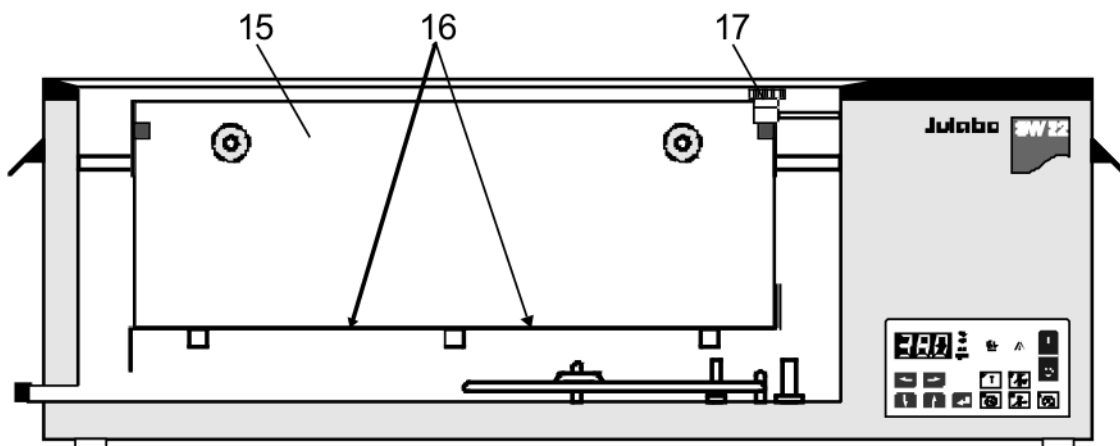
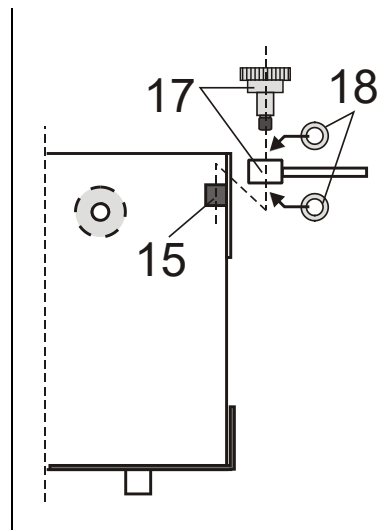

4. Safety notes for the user

4.1. Explanation of safety notes



In addition to the safety warnings listed, warnings are posted throughout the operating manual. These warnings are designated by an exclamation mark inside an equilateral triangle. “Warning of a dangerous situation (Attention! Please follow the documentation).”

The danger is classified using a signal word.

Read and follow these important instructions for averting dangers.



Warning:

Describes a **possibly** highly dangerous situation. If these instructions are not followed, serious injury and danger to life could result.



Caution:

Describes a **possibly** dangerous situation. If this is not avoided, slight or minor injuries could result. A warning of possible property damage may also be contained in the text.



Notice:

Describes a **possibly** harmful situation. If this is not avoided, the product or anything in its surroundings can be damaged.

4.2. Explanation of other notes



Note!

Draws attention to something special.



Important!

Indicates usage tips and other useful information.

4.3. Safety instructions

Follow the safety recommendations to prevent damage to persons or property. Further, the valid safety instructions for working places must be followed.



- Only connect the unit to a power socket with earthing contact (PE – protective earth)!
- The power supply plug serves as a safe disconnecting device from the line and must always be easily accessible.
- Operation is permitted with **non-flammable** liquids only.
- Place the instrument on an even surface on a pad made of **non-flammable** material.
- Do not stay in the area below the unit.
- Make sure you read and understand all instructions and safety precautions listed in this manual before installing or operating your unit.
- Check the filling level of the bath fluid from time to time. The heater must always be fully covered with the bath fluid!

- Never operate the unit without bath fluid in the bath.
- Do not drain the bath fluid while it is hot!
Check the temperature of the bath fluid prior to draining (by switching the unit on for a short moment for example).
- Never operate damaged or leaking equipment.
- Always turn off the unit and disconnect the mains cable from the power source before performing any service or maintenance procedures, or before moving the unit.
- Transport the unit with care.
- Sudden jolts or drops may cause damage in the interior of the unit.
- Always empty the bath before moving the unit.
- Never operate equipment with damaged mains power cables.
- Observe all warning labels.
- Never remove warning labels.
- Condensation that could appear in and on other units near the water bath may result in reduced operating safety.
Be careful when setting up and operating the water bath!
- Always turn off the unit and disconnect the mains cable from the power source before cleaning the unit.
- Repairs are to be carried out only by qualified service personnel.



- Some parts of the bath cover may become extremely warm during continuous operation.
When lifting the bath cover, pay attention to hot steam!
- Be careful when touching these parts!
- Use safety glasses!

5. Preparations

5.1. Installation



Caution:

The unit is not for use in explosive environment.

The installation site should meet the following conditions:

1. The base of the installation site should be level to ensure proper functioning of the safety features.
2. The laboratory table, for example, should be sturdy enough, to where the shaking frequency cannot cause vibration of the table. Consider that the masses moved may be in the order of several kg.
 - Keep a wall distance of minimum 80 mm.
 - Do not cover the ventilation openings on the floor and rear side of the bath.

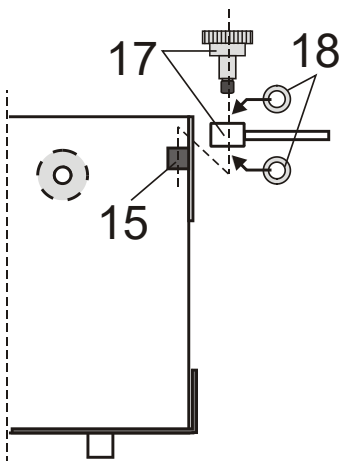
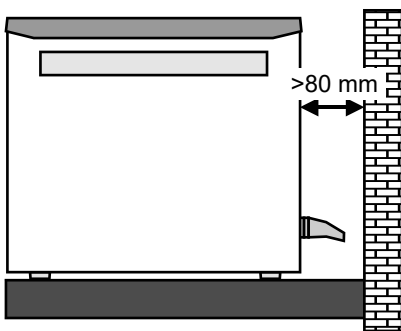

Installing and removing the shaking carriage:

- Holding screw (17) can be removed without the use of tools. **Retain** plastic **washers** (18) on both sides of the push rod.
- The shaking carriage can be completely removed. Samples can be added to the carrier trays while outside of the bath.
- Then put the shaking carriage back into place. Use the holding screw and plastic washers (18) to screw the push rod onto the shaking carriage (15). Tighten the holding screw securely.



Caution:

The shaking frequency may cause a laboratory table to oscillate. At operation, the vibration may cause items on the table top to fall off under extreme unfavourable circumstances.

- Carefully choose the setup location.
- Shaking frequency is adjustable. After readjusting shaking frequency, always observe other objects near the shaking water bath and remove them to a different location if necessary.

**Caution:****Potential hazards from the samples**

Proper use of shaking water baths includes immersion of samples contained in test tubes, Erlenmeyer flasks, or other containers for the purpose of controlling their temperature.

We do not know which substances are contained within these vessels.

Many substances are:

- **inflammable, easily ignited or explosive**
- **hazardous to health**
- **environmentally unsafe**

i.e.: **dangerous**

The user alone is responsible for the handling of these substances!

- Always properly seal all sample containers.

**Notice:**

There is a danger of electrochemical oxidation or corrosion when using test-tube racks or samples made of non-ferrous metal.

- Avoid using these types of racks or samples.
- Use only original JULABO test-tube racks.

5.2. Bath liquid

Recommended bath fluids: soft/decalcified water.

**Caution:****Poor water quality may result in corrosion in the bath.**

The quality of water (tap water) depends on local conditions.

- Due to the high concentration of lime, hard water is not suitable for temperature control because it leads to calcification in the bath.
- Ferrous water can cause corrosion - even on stainless steel.
- Chloric water can cause pitting corrosion.
- Distilled and deionized water is unsuitable. Their special properties cause corrosion in the bath, even in stainless steel.

JULABO takes no responsibility for damages caused by the selection of an unsuitable bath fluid.

Please contact JULABO before using other than recommended bath fluids.

Do not use flammable bath fluids!

5.3. Filling / Draining

Filling:

- Maximum filling level: 6 cm below the bath rim
- Minimum filling level: 7 cm (level approx. 3 cm above surface (16) for the placement of items/fixtures)



Note:

The working filling level depends on size and number of the items (fixtures) to be placed inside.

Fill to minimum level only. Insert the complemented shaking carriage and correct the filling level (adding or removing liquid) as required

Use the water bath cover to keep temperature losses to a minimum:

Lift-up Makrolon[®] cover see page 20

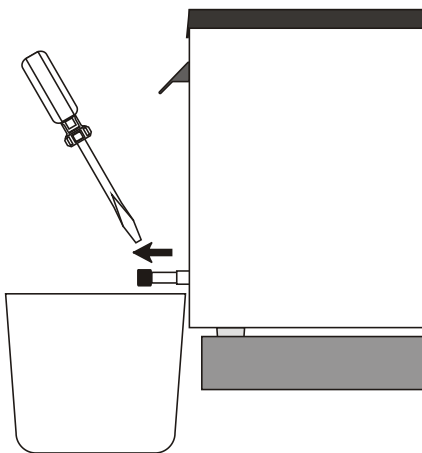

Draining:

- Switch off the shaking water bath with the mains switch and move the equipment to the table edge.
- Place a suitable collecting bucket or tub underneath the equipment for draining the used liquid.
- To drain the liquid open the drain screw (11) on the side of the water bath.
- After the liquid has been fully drained, securely tighten the drain screw (11) again.



Warning:

There are thermal dangers when opening the bath cover:
Burn, scald, hot steam, hot parts and surfaces that can be touched.

- Do not drain the bath fluid while it is hot!
- Check the temperature of the bath fluid prior to draining (by switching the unit on for a short moment, for example).

5.4. Maintaining a constant water level / Counter cooling

For cooling tasks near the ambient air temperature the liquid level/cooling set can be used for counter cooling.

By special pipe routing, cool faucet water is continuously supplied to the water bath, while at the same time, the heated water is drained via the overflow connection of the Level/Cooling set.

- ① A specific water flow rate of 100 ml/minute is sufficient to compensate for the characteristic temperature.



Caution:

Securely attach all tubing to prevent slipping.
Observe the laws and regulations of the water distribution company valid in the location where the unit is operated.

Use of the liquid level/cooling set for a continuous supply of faucet water:

1. to keep the water level constant, especially for applications up to the boiling point (supply of faucet water only in the amount of evaporation losses).
2. for countercooling of cooling tasks near the ambient surrounding temperature (cool faucet water is continuously supplied to the water bath, while at the same time, the heated water is drained via the overflow connection of the liquid level/cooling set).

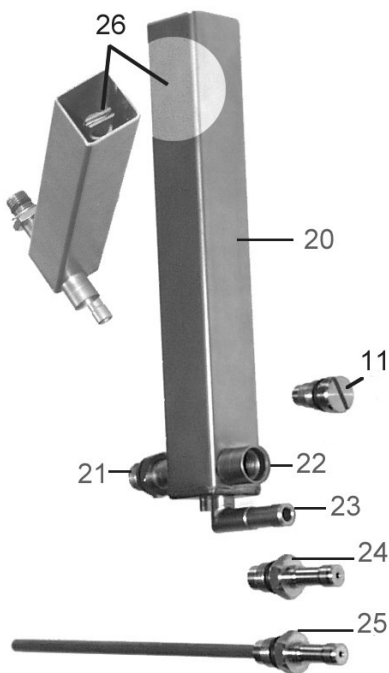

- 11 drainage screw on water bath
- 20 compensation reservoir
- 21 connecting sleeve
- 22 supply/drainage sleeve
- 23 overflow sleeve
- 24 adaptor screw for constant liquid level function
- 25 adaptor screw assy. for countercooling function and simultaneous constant liquid level control
- 26 adjuster screw for filling level adjustment



5.5. Accessories

Bath covers

Recommendation:

Use the water bath cover to keep temperature losses to a minimum. This is especially important for working temperatures above 60 °C.

Order No.	Description
8 970 288	Lift-up Makrolon® cover (to +80 °C)
8 970 268	Lift-up stainless steel cover (to +100 °C)

Cooling installation / continuous water supply

Recommendation:

For continuous water supply and counter-cooling

Order No.	Description
8 970 415	Liquid level/cooling set
8 970 416	Cooling coil

6. Operating procedures

6.1. Power connection





Caution:

- Only connect the unit to a power socket with earthing contact (PE – protective earth)!
- The power supply plug serves as safe disconnecting device from the line and must be always easily accessible.
- Never operate equipment with damaged mains power cables.
- Regularly check the mains power cables for material defects (e.g. for cracks).
- We disclaim all liability for damage caused by incorrect line voltages!

Check to make sure that the line voltage matches the supply voltage specified on the identification plate.

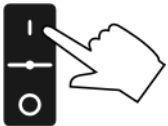
7. Switching on



- Switching on:
Turn on the mains power switch.
- ① The unit performs a self-test. All segments of the 4-digit MULTI-DISPLAY (LED) and all indicator lights will illuminate. Then the software version (example: n 1.3) appears. Together with the display of the water bath temperature the operating state is also displayed.
(Example: 18.6 °C)
The monitor lamp  illuminates when the heater is in operation (on).

Notes:

- ① Adjustable parameters and temperature values are retained and the electronic timer is reset to zero when the equipment is switched off.
- ① When the shaking water bath is operating under remote control at the time of switchoff (connected to PC via RS-232 interface connection), the MULTI-DISPLAY (LED) will display the message „OFF“.
(see chapter 8.5. Setup for remote control)
- ① If shaking operation is not desired it can be switched off at menu level. Select the menu level and activate the option SA (see page 26).

7.1. Setting the temperature



Display and adjustment of the working temperature:

- ① Press the setpoint key . The indicator light **blinks** and the value previously set appears on the MULTI-DISPLAY (LED). (example: 25.0 °C).
- ② If no further key is pressed the display will return to show the actual bath temperature after approx. 8 seconds.
- ② Use the cursor keys to move left or right on the display until the numeral you wish to change is blinking.
- ③ Use the increase/decrease arrows to change the selected numeral (0, 1, 2, 3, ... 9).
- ④ Press enter to store the selected value (example: 38.0 °C).

The working temperature is maintained constant after a short heat-up time (e. g. 38.0 °C).



Notice:

When the working temperature is higher than 50 °C, it might happen that due to strong production of steam there is considerable dripping on the inside of the lift-up Makrolon[®] cover. Some drops may fall directly into the material to be tempered.

- Always properly seal all sample containers.

7.2. Warning functions or temperature limit



More protection for your samples in the bath!

As soon as the actual temperature leaves one of the pre-adjusted limits, this status is evaluated.

The high- and low-temperature limit can be evaluated in two ways (see page 31).



1. As pure warning function with an acoustic signal in regular intervals. (Signal - Pause)
2. As temperature limit by switching-off the heating and alarm.

Display and adjustment of over-/undertemperature:

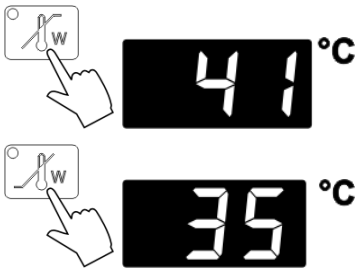

① Press the key

(example: 41 °C)

or

(example: 35 °C).

The indicator light **blinks** and the value previously set appears on the MULTI-DISPLAY (LED).

① If no further key is pressed the display will return to show the actual bath temperature after approx. 8 seconds.

② Use the cursor keys to move left or right on the display until the numeral you wish to change is blinking.

③ Use the increase/decrease arrows to change the selected numeral (0, 1, 2, 3, ... 9).

④ Press enter to store the selected value

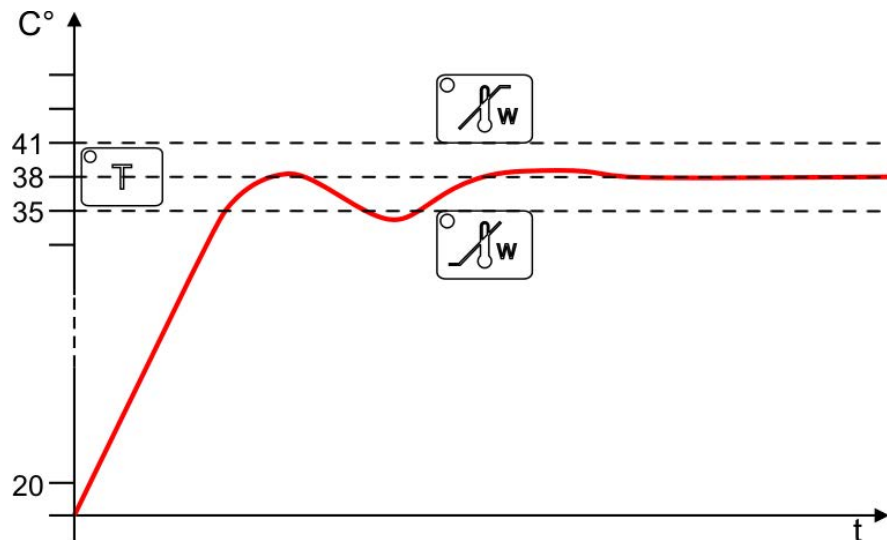

Note:

The warning functions will be activated only after the bath temperature has remained for at least 3 seconds within the adjusted threshold values after the equipment is switched on.

7.3. Adjustment of the shaking frequency





The shaking frequency is adjustable between 20...200 rpm. If shaking operation is not desired it can be switched off at menu level. Select the menu level and activate the option SA (see page 26)



Display and adjustment of the shaking frequency

- ① Press the key .
The indicator light **blinks** and the value previously set appears on the MULTI-DISPLAY (LED).
(example: 120 rpm).

① If no further key is pressed the display will return to show the actual bath temperature after approx. 8 seconds.

- ② Use the cursor keys   to move left or right on the display until the numeral you wish to change is blinking.
- ③ Use the increase/decrease arrows   to change the selected numeral (0, 1, 2, 3, ... 9).
- ④ Press enter  to store the selected value



Caution:

Danger of injury. Samples may fall over.

- Do NOT reach in the shaking carriage during shaking operation. Danger of injury!
- Always use carrier trays in order to prevent sample containers from falling over.

7.4. Electronic timer

The electronic timer enables adjustment of the operating time up to a maximum of 9 hours and 59 minutes. Countdown then commences to zero, at which time an acoustical time signal will be issued in intervals (double signal - pause).

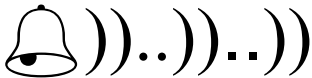

- the equipment will not be switched off -

Display and adjustment of the operating time:







- ① Press the key .

The indicator light **blinks** and the MULTI-DISPLAY (LED) will display the remaining operating time (example: 4.28 h:m).



- ① If no further key is pressed the display will return to show the actual bath temperature after approx. 8 seconds.

- ② Use the cursor keys   to move left or right on the MULTI-DISPLAY (LED) until the numeral you wish to change is blinking.

- ③ Use the edit keys   to increase or decrease the numeral value (0, 1, 2, 3, ... 9).

- ④ Press enter  to store the value when the countdown will commence. During that time the monitor lamp (control lamp) will remain permanently illuminated.



When the operating time is expired an acoustical time signal is issued in intervals.

Cancellation of the time signal:



Press enter  to silence the time signal.

Notes:

1. Following switch-on of the equipment and after a power failure, the timer will show 0:00 h:m.
2. When the equipment is operating remotely controlled the timer is rendered inoperative.



8. Menu functions

Adjustment of parameters which, in most instances, need only be adjusted once, are performed on the water bath at menu level.







1. Shaking operation On/Off
2. Circulator pump On/Off
(Only shaking water bath SW23).
3. MULTI-DISPLAY temperature display in °C or °F
4. ATC (absolute temperature calibration)
5. Switchover to remote controlled operation
6. Adjustment of interface parameters
7. Adjustment of the high and low temperature limit. Choice between pure warning function or a temperature limit by switching off the heating.

Selecting/exiting the menu level.

- Simultaneously press the cursor key  and enter .

8.1. Shaking operation On/Off



1. Press the cursor key  and enter  **at the same time.**
2. Use the cursor keys   to select the menu option „shaking operation“
example: „SA1“ = shaking frequency ON.
3. Select the alternative state with the edit keys   and confirm the selection with the ENTER key .
The display now shows „SA0“ = shaking frequency OFF.

8.2. Circulator pump on/off

Only shaking water bath SW23 feature a circulator pump. The pump can be set to **on** and **off** at the menu level. At working temperatures > 80° C the pump will switch off automatically

The image shows a black rectangular LED display with the white characters 'Pu1'.

The image shows a black rectangular LED display with the white characters 'Pu0'.

1. Press and at the same time.
2. Use the cursor keys to select the menu option PUMP
(example: „Pu1“ = Pump ON)
3. Select the alternative state with the edit keys and confirm the selection with the ENTER key (example: „Pu0“ = Pump OFF).
4. Press and at the same time.

8.3. Temperature indication in °C or °F

The working temperature can be displayed in the MULTI-DISPLAY (LED) in °C or °F as desired.

The image shows a black rectangular LED display with the white characters 't C'.

The image shows a black rectangular LED display with the white characters 't F'.

1. Press and **at the same time**.
2. Use the cursor keys to select the menu option „temperature display“
(example: „t C“ = temperature display in °C).
3. Select the alternative state with the edit keys and confirm the selection with the ENTER key . The display now shows „t F“ = temperature display in °F.
4. Press and **at the same time**.

Switchover to the selected display mode takes place automatically upon leaving the menu level.

8.4. ATC - Absolute Temperature Calibration

 37.0 °C

Internal sensor (T_F)

ATC serves to compensate a temperature difference that might occur between circulator and a defined measuring point in the bath tank because of physical properties.







 36.8 °C

Measuring point (T_M)

The difference temperature is determined ($\Delta T = T_M - T_T$) and stored as correcting factor (example $\Delta T = -0.2$ °C).





 At0

 At1

1. Press the cursor key  and enter  at the same time.
2. Use the cursor keys   to select the menu option „At0“.
3. With the edit keys   select "At1" and then press enter .

Enter the corrective value.

 -0.2 °C

4. Using the cursor keys   and the edit keys   set the correcting factor (example -0.20 °C) and then press enter .

5. Press  and  at the same time.

 37.0 °C

Measuring point

The temperature on the measuring point rises to a temperature of 37.0 °C and is indicated on the MULTI-DISPLAY (LED).



The ATC function stays activated until resetting to 00.0 °C.



Recommendation:







Use a calibrated temperature measuring instrument.

8.5. Setup for remote control

If the shaking water bath is to be remotely controlled or monitored, the parameter of the menu option REMOTE must be changed and set from **0** to **1**.

REMOTE 0 = Keypad control
1 = Remote control via RS232 interface











1. Press  and  **at the same time.**
2. Use the cursor keys   to select the menu option REMOTE (display „r 0“).
3. Select the alternative state with the edit keys   and confirm the selection with the ENTER key  (display „r 1“).

The shaking water bath will switch to the REMOTE „STOP“ condition and the MULTI-DISPLAY will show the message „OFF“.

4. Press  and  **at the same time.**

8.6. Adjusting interface parameters

Correct data transmission takes place only when the interface parameters of PC and water bath are identical.

1. Press  and  at the same time.
2. Use the cursor keys   to select the desired menu option (BAUDRATE, PARITY, HANDSHAKE).
3. Select the alternative state with the edit keys   and confirm the selection with the ENTER key .
4. Press  and  at the same time.

Adjustable interface parameters



BAUDRATE 48 = 4800 bauds *
 96 = 9600 bauds

PARITY 0 = no parity
 1 = odd parity
 2 = even parity *

HANDSHAKE
 0 = Protocol Xon/Xoff (software handshake)
 1 = without handshake *
 Data bits = 7
 Stop bit = 1 *

(*Factory setting)



Like all parameters which can be entered through the keypad, interface parameters are stored in memory even after the circulator is turned off.

8.7. Evaluation of the temperature limits

The high- and low-temperature limit can be adjusted in two ways (see page 22)



3. As pure warning function with an acoustic warning signal in regular intervals.

Adjustment „Li 0“ – factory adjustment



4. As temperature limit by switching-off the heating. Adjustment „Li 1“

The alarm is indicated by optical and audible signals (continuous tone) and on the MULTI-DISPLAY (LED) appears the error message "Error 01".

1. Press and at the same time.
2. Use the cursor keys to select the menu option Limit. (example: „Li 0“).
3. Select the alternative state with the edit keys and confirm the selection with the ENTER key (display „Li 1“).
4. Press and at the same time.

9. Safety installation (with shutdown function)

(excess temperature protection)



These safety installations is independent of the control circuit. When the temperature of the bath liquid has reached the safety temperature, a complete shutdown of the heater and pump (only CW-models) is effected.

The alarm is indicated by optical and audible signals (continuous tone) and on the MULTI-DISPLAY (LED) appears the error message "Error 01".

10. Troubleshooting guide / Error messages



Whenever the microprocessor electronics registers a failure, a complete shutdown of the heater and circulation pump is performed.

The alarm light "▲" illuminates and a continuous signal tone sounds.



- Cause:
The waterbath is operated without bath liquid, or the liquid level is insufficient
or
The adjusted temperature limit was exceeded or the temperature fell below the limit.
- Remedy: Replenish the bath tank with the bath liquid.
Control the adjustment of the temperature limit.
Get to safety the samples.



- ① The wires of the working temperature sensor are interrupted or short-circuited.



}
} other errors
}

- Heating circuit interrupted.
- Short-circuit of triac.
- Short-circuit in alarm relay.

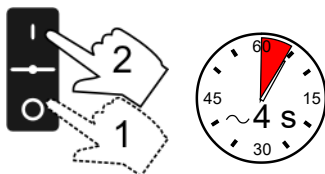

After eliminating the malfunction, press the mains power switch off and on again to cancel the alarm state.

If the unit cannot be returned to operation, contact an authorized JULABO service station.

Disturbances that are not indicated.



Warning:

Danger of electric shock!

- The exchanging of the fuses are to be carried out only by qualified service personnel.
- Before exchanging the fuses, turn off the mains power switch and disconnect the power plug from the mains socket!
- Only use fine fuses with a nominal value as specified.

Mains fuses

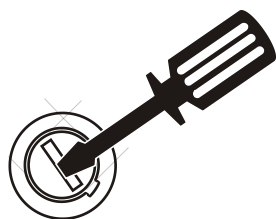

- Pull the mains plug from the power outlet before opening the equipment!
- The mains fuses are located behind side plate (13). The side plate is fastened to the casing with 6 screws. (Fine fuse T 10.0 A, dia. 5 x 20 mm)

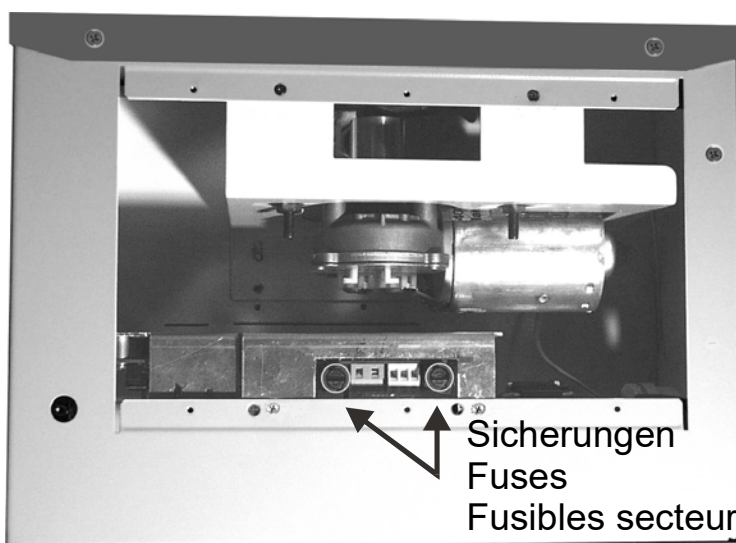

Pump motor overload protection

The pump motor is protected against overloading. After a short cooling interval, the motor will automatically start running.

10.1. Acoustical signals and their differentiation

Three different signals are generated by the sound generator as follows:

- an alarm signal
- a warning signal
- a time signal

The signals can easily be recognized and differentiated, even from a good distance. Required actions can be initiated immediately.

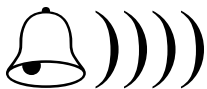

- The **Alarm signal** is a continuous sound signal.

Heater and circulator pump (SW23 only) are completely and permanently switched off.
(see page 31)

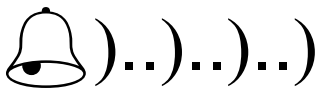

- The **warning signal** is issued at regular intervals (signal - pause - signal - pause).

The actual bath temperature is higher than the set overtemperature value or lower than the set undertemperature value
(see page 22)

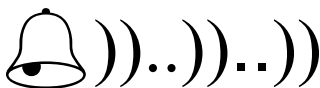

- The **time signal** is issued in the intervals (double signal - pause - double signal - pause).

Countdown of the adjusted operating time commences to zero, after which a time signal is issued at intervals
(see page 25)



11. Electrical connection

RS232C serial interface

This port can be used to connect a computer with an RS232C cable for remote control of the waterbath.

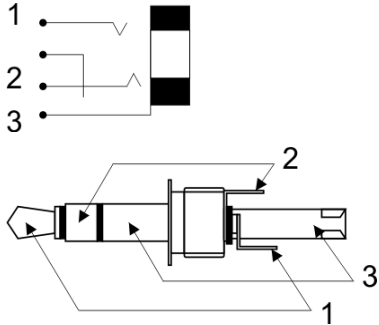

Pin assignment:

Pin 1	RxD	Receive Data
Pin 2	TxD	Transmit Data
Pin 3	0 VD	Signal GND

Use shielded cables only.

Accessories:

RS-232 interface connecting cable, terminated with 3-pin Cinch plug and 9 hole subD socket. Length: 3.0 m.

Order No.: 8 980 075

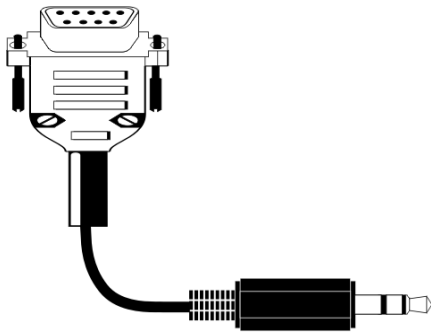

12. Remote control

12.1. Communication with a PC or a superordinated data system

A suitable terminal program for communicating with a PC is:
Terminal.EXE (included with MS-Windows).

If the waterbath is put into remote control mode via the menu level, the display will read "OFF" = REMOTE STOP. (see page 29).

The waterbath is now operated via the computer.
In general, the computer (master) sends commands to the waterbath(slave). The waterbath sends data (including error messages) only when the computer asks for it.

A transfer sequence consists of:

- command
- space ⇔; Hex: 20)
- parameter (the character separating decimals in a group is the period)
- end of file (↵; Hex: 0D)
-

The commands are divided into **in** or **out** commands.

in commands: asking for parameters to be displayed

out commands: setting parameters







The **out** commands are valid only in remote control mode.

Examples:

- Command to set the working temperature T to 55.5 °C:
out_sp_00 ⇔ 55.5↵
- Command to ask for the working temperature T:
in_sp_00↵
- Response from the shaking water bath:
55.5↵



12.2. List of commands

Command	Parameter	Response of the shaking water bath
version	none	Number of software version(V X.xx)
status	none	Status message, error message (see below)
out_mode_05	0	STOP - returns the water bath to the „OFF“ state
out_mode_05	1	START - water bath is switched to the operating state
out_mode_08	0	Circulator pump „OFF“
out_mode_08	1	Circulator pump „ON“
out_mode_09	0	Shaking operation drive motor „OFF“
out_mode_09	1	Shaking operation drive motor „ON“
out_sp_00	xxx.x	Set working temperature„T“
out_sp_02	xxx.x	Set high temperature warning limit 
out_sp_03	xxx.x	Set low temperature warning limit 
out_sp_16	xxx.x	Set shaking frequency
in_sp_00	none	Ask for working temperature „T“
in_sp_02	none	Ask for high temperature warning limit 
in_sp_03	none	Ask for low temperature warning limit 
in_sp_16	kein	Ask for shaking frequency
in_pv_00	none	Ask for actual bath temperature
in_pv_01	none	Ask for the heater wattage being used

12.3. Status messages

Message	Description
01 MANUAL START	Waterbath in keypad control mode.
02 REMOTE STOP	Waterbath in „OFF“ state
03 REMOTE START	Waterbath in remote control mode

12.4. Error messages

Message	Description
-01 TEMP / LEVEL ALARM	Safety temperature or low liquid level alarm
-03 EXCESS TEMPERATURE WARNING	High temperature warning „  „
-04 LOW TEMPERATURE WARNING	Low temperature warning „  „
-05 TEMPERATURE MEASUREMENT ALARM	Error in measuring system
-07 I ² C-BUS WRITE ERROR -07 I ² C-BUS READ ERROR -07 I ² C-BUS READ/WRITE ERROR	Internal error
-08 INVALID COMMAND	Invalid command
-10 VALUE TOO SMALL	Entered value too small
-11 VALUE TOO LARGE	Entered value too large
-12 WARNING : VALUE EXCEEDS TEMPERATURE LIMITS	Value lies outside the adjusted range for the high and low temperature warning limits. But value is stored.
-13 COMMAND NOT ALLOWED IN CURRENT OPERATING MODE	Invalid command in current operating mode

13. Cleaning / repairing the unit



Caution:

Improper maintenance or repair can result in electric shock or damage to the unit.

- Repairs and any other work are to be carried out only by qualified service personnel authorized by JULABO.
- Always turn off the unit and disconnect the mains cable from the power source before performing any service or maintenance procedures, or before moving the unit.
- Prevent humidity from entering into the water bath.
- Do not use alcohol-based or solvent-based cleaning agents. These cleaning agents will result in damage and cracks in the Makrolon® cover.

Cleaning:

For cleaning the bath tank and the immersed parts of the water bath, use low surface tension water (e.g., soap suds).

Clean the outside of the unit using a wet cloth and low surface tension water.

The JULABO Skaking Water Baths are designed for continuous operation under normal conditions. Periodic maintenance is not required.

The tank should be filled only with a bath fluid recommended by JULABO. To avoid contamination, it is essential to change the bath fluid from time to time.

Repairs:

Before asking for a service technician or returning a JULABO instrument for repair, please contact an authorized JULABO service station.

JULABO Technical Service

Tel.: +1(610) 231-0250 Option 3

Fax: +1(610) 231-260

Email: Service@julabo.us

Returning a unit:

When returning the unit:

- Clean the unit and, if necessary, decontaminate the unit in order to avoid endangering service personnel.
- Attach a short fault description.
- During transport the unit has to stand upright. Mark the packing correspondingly.
- When returning a unit, take care of careful and adequate packing.
- JULABO is not responsible for damages that might occur from insufficient packing.

14. Warranty conditions

The following Warranty Provisions shall apply to products sold in North America by Julabo ("Seller") to the entity shown as buyer ("Buyer") on Seller's invoice.

Initial Warranty

Upon Seller's receipt of payment in full for the products and subject to Buyer's compliance with the terms of sale and any other agreement with Seller relating to the products, Seller warrants to the Buyer that the products manufactured by the Seller are free from defects in material and workmanship for a period not to exceed two (2) years of operation from the date the product is shipped by Seller to Buyer (the "Initial Warranty").

EXCLUSION OF ALL OTHER EXPRESS WARRANTIES; EXCLUSION OF ALL IMPLIED WARRANTIES.

OTHER THAN THE INITIAL WARRANTY, NO OTHER EXPRESS WARRANTIES ARE MADE. ALL IMPLIED WARRANTIES OF EVERY TYPE AND KIND, INCLUDING BUT NOT LIMITED TO ANY IMPLIED WARRANTY OF MERCHANTABILITY OR FITNESS FOR A PARTICULAR PURPOSE OR USE, ARE EXCLUDED IN ALL RESPECTS AND FOR ALL PURPOSES. SELLER DISCLAIMS AND MAKES NO IMPLIED WARRANTIES WHATSOEVER.

Exclusions

The Initial Warranty does not include damage to the product resulting from accident, misuse, improper installation or operation, unauthorized or improper repair, replacement or alteration (including but not limited to repairs, replacements, or alterations made or performed by persons other than Seller's employees or authorized representatives), failure to provide (or use of improper) maintenance, unreasonable or unintended use or abuse of the product, or failure to follow written installation or operating instructions.

Buyer must return the product's record of purchase to the Seller or one of Seller's authorized representatives within thirty (30) days of the date the product is shipped by Seller to Buyer in order to make a claim under the Initial Warranty. Notwithstanding anything contained herein to the contrary, all glassware, including but not limited to reference thermometers, are expressly excluded from the Initial Warranty.

Buyer's sole remedies; Limitations on Seller's Liability

Buyer's sole and exclusive remedy under the Initial Warranty is strictly limited, in Seller's sole discretion, to either: (i) repairing defective parts; or (ii) replacing defective parts. In either case, the warranty period for the product receiving a repaired or replaced part pursuant to the terms of the Initial Warranty shall not be extended. All repairs or replacements performed by Seller pursuant to these Warranty Provisions shall be performed at one of the Seller's facility in Allentown, Pennsylvania, U.S.A. or at the facility of an authorized representative of Seller, which location shall be determined by Seller in its sole discretion; provided, however, that Seller may, in its sole discretion perform such repairs or replacements at Buyer's facility in which case Buyer shall pay Seller's travel, living and related expenses incurred by Seller in performing the repairs or replacements at Buyer's facility. As a condition precedent to Seller's obligation to repair or replace a product part under the Initial Warranty, Buyer shall (i) promptly notify Seller in writing of any such defect; (ii) shall have returned the product's record of purchase to Seller or to Seller's authorized representatives within thirty (30) days of the date the product is shipped by the seller; and (iii) assist Seller in all respects in its attempts to determine the legitimacy and basis of any claims made by or on behalf of Buyer including but not limited to providing Seller with access to the product to check operating conditions. If Buyer does not provide such written notice to Seller within the Initial Warranty period or fails to return the product's record of purchase as set forth above, Seller shall have no further liability or obligation to Buyer therefor. In no event shall Seller's liability under the Initial Warranty exceed the original purchase price of the product which is the subject of the alleged defect.

THE REMEDIES PROVIDED IN THE INITIAL WARRANTY ARE THE SOLE AND EXCLUSIVE REMEDIES AVAILABLE TO THE BUYER. NOTWITHSTANDING ANYTHING TO THE CONTRARY CONTAINED HEREIN,

AND EVEN IF THE SOLE AND EXCLUSIVE REMEDIES FAIL OF THEIR ESSENTIAL PURPOSE FOR ANY REASON WHATSOEVER, IN NO EVENT SHALL SELLER BE LIABLE FOR BUYER'S MANUFACTURING COSTS, LOST PROFITS, GOODWILL, OR ANY OTHER SPECIAL, INDIRECT, PUNITIVE, INCIDENTAL OR CONSEQUENTIAL DAMAGES TO BUYER OR ANY THIRD PARTY AND ALL SUCH DAMAGES ARE HEREBY DISCLAIMED.

Assignment

Buyer shall not assign any of its rights or obligations hereunder without the prior written approval of Seller; provided, however, that if Buyer is a distributor of Seller, the rights and obligations of Buyer under these Warranty Provisions shall inure to the benefit of and be binding upon Buyer's customers who provide the product's proof of purchase to Seller pursuant to the terms set forth herein. Seller may assign any or all of its rights or obligations hereunder without Buyer's prior consent.

Governing Law

The Warranty Provisions and all questions relating to their validity, interpretation, performance, and enforcement shall be construed in accordance with, and shall be governed by, the substantive laws of the Commonwealth of Pennsylvania without regard to its principles of conflicts of law.

Waiver

Any failure of the part of Seller to insist on strict compliance with the Warranty Provisions shall no way constitute a waiver of such right. No claim or rights arising out of a breach of the Warranty Provisions by Buyer may be discharged in whole or in part by a waiver of the claim or right, unless the waiver is in writing signed by an authorized representative of Seller. Seller's waiver or acceptance of any breach by Buyer of any provisions of the Warranty Provisions shall not constitute a waiver of or an excuse for nonperformance as to any other provision of the Warranty Provisions nor as to any prior or subsequent breach of the same provision.

Freight

Seller will arrange and pay for shipping and handling for the return of the unit to the Buyer.

Out of Box Failure (OBF)

An Out of Box Failure (OBF) is defined as a product failure immediately following unpacking and installation of a newly delivered product. JULABO provides a 14-day grace period after the date of shipment, during which time the delivered product must be checked for defect. The same exclusions that apply to the regular warranty also apply to OBF classification. For example, JULABO will not be liable for transport damage, damage inflicted by the customer or any other party, or defects arising from improper installation or usage.

