

IKA

designed for scientists

VACSTAR lite

ENGLISH

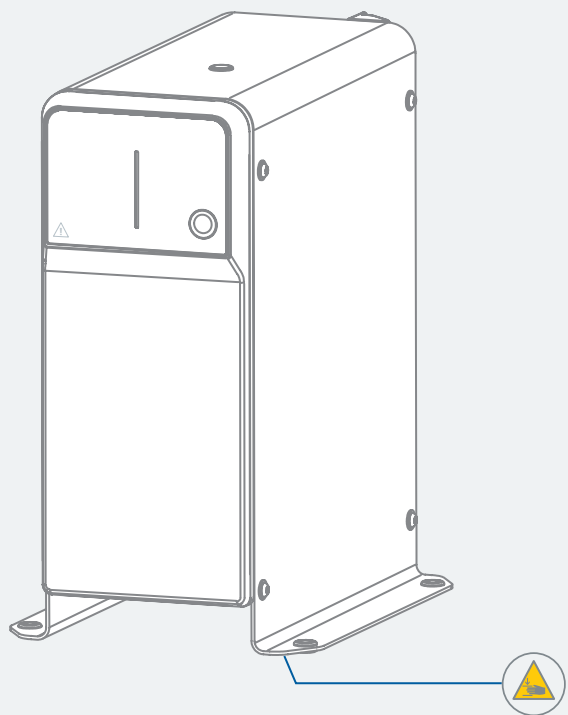









Fig. 1

	EU Declaration of conformity	6
	Explication of warning symbols	6
	Safety instructions.....	7
	Intended use.....	10
	Unpacking	11
	Useful information	12
	Operator panel and display	14
	Installation	15
	Operation	17
	Interfaces and outputs	18
	Maintenance and cleaning.....	20
	Accessories	20
	Material of parts in contact with medium.....	20
	Error codes	21
	Technical Data	22
	Warranty	23



EU Declaration of conformity





We declare under our sole responsibility that this product corresponds to the directives 2014/35/EU, 2006/42/EC, 2014/30/EU and 2011/65/EU and conforms with the following standards or normative documents: EN 61010-1, EN 61326-1, EN 60529 and EN ISO 12100.

A copy of the complete Declaration of Conformity or further declarations of conformity can be requested at sales@ika.com.







Explication of warning symbols

/// Warning symbols

-  **Danger!** Indicates an (extremely) hazardous situation, which, if not avoided, will result in death, serious injury.
-  **Warning!** Indicates a hazardous situation, which, if not avoided, can result in death, serious injury.
-  **Caution!** Indicates a potentially hazardous situation, which, if not avoided, can result in injury.
-  **Notice!** Indicates practices which, if not avoided, can result in equipment damage.
-  **Caution!** Indicates crushing risk to fingers / hands.

/// General Symbols

-  **A** — Position number
Indicates device components relevant to actions.
-  **Correct / result**
Indicates the correct execution or the result of an action step.
-  **Wrong**
Indicates the incorrect execution of an action step.
-  **Note**
Indicates steps of actions that require particular attention.

Safety instructions



/// General information

- › **Read the operating instructions completely before starting up and follow the safety instructions. If this device is used with another device, observe also its operating instructions.**
- › Keep the operating instructions in a place where it can be accessed by everyone.
- › Ensure that only trained staff work with the device.
- › Follow the safety instructions, guidelines, occupational health and safety and accident prevention regulations.
- › The device must only be used in a technically perfect condition.

Notice!

- › Pay attention to the marked sites in **Fig. 1**.

/// Device design

Caution!

- › Ensure that your hands / fingers do not get crushed when setting down the device.

Notice!

- › Set up the device in a spacious area on an even, stable, clean, non-slip, dry and fireproof surface.
- › Set up the device in accordance with the chapter "Installation" and connect the connection lines and interfaces as described.
- › Never work with a faulty or incorrectly connected device.
- › Set up the vacuum pump in appropriate and functioning extractor hoods, or set up an exhaust gas line to them. Ensure that the exhaust gas line cannot be kinked! The maximum permitted exhaust gas line length is 2 metres.
- › Prevent occurrence of explosive mixtures; if appropriate connect inert gas for ventilation and / or thinning.

/// Working with the device

Danger!

- › Do not use the device in explosive atmospheres, it is not EX-protected.
- › With substances capable of forming an explosive mixture, appropriate safety measures must be applied, e.g. working under a fume hood.
- › To avoid body injury and property damage, observe the relevant safety and accident prevention measures when processing hazardous materials.
- › The device and all parts of the device must not be used on people or animals.
- › Do not expose human or animal body parts to vacuum.
- › You can prevent the release of solvent vapours into the atmosphere using a downstream emission condenser.
- › The device is not suitable for use with self-igniting materials, materials that are flammable without an air supply, or explosive materials.
- › Do not operate the vacuum pump while it is open. Otherwise there is a danger of severe injuries as a hand may be pulled into the moving parts.

Warning!

- › Inhaling or coming into contact with media such as poisonous liquids, gases, spray mists, vapours, dusts or biological materials can endanger the health of the user. Ensure that all connections are well sealed and free of leaks if you are working with such media.
- › Prevent release of the materials listed above. Take measures to protect staff and the environment.

Notice!

- › The vacuum pump must only be operated under the conditions escribed in the chapter "Technical data".
- › Pay attention to possible interactions or chemical or physical reactions when working with media at reduced pressure and increased temperature.
- › There can be electrostatic processes between the medium and the device which can lead to direct danger.
- › Some medium may be released due to the residual leakage rate of the device.
- › Only switch the pump on if the pump is standing vertically.
- › Connect the hose connections (INLET-OUTLET) and interfaces in accordance with the labelling on the device and the operating instructions.
- › Ensure that the temperature of the evacuated medium is below its ignition temperature. The pumping process (compression) increases the temperature of the medium additionally.
- › Please note that vapours containing solvent can be sucked into the pump.
- › Do not use the pump to create pressure.
- › Observe the permitted pressure at the inlet and outlet side; see the chapter "Technical data".
- › The gas flow must only be regulated / throttled in the suction-side line.
- › Use a solenoid valve or a check valve in the suction line if there are several load units.
- › When using an emission condenser ensure that the coolant is flowing freely.
- › Ensure that the substances used with the device are compatible with the materials of the device parts that come into contact with the product; see the chapter "Material of parts in contact with medium".
- › Covers or parts that can be removed from the device without tools must later be refitted to ensure safe operation, unless anything else is connected at this point. This will prevent the infiltration of foreign objects, liquids and other contaminants.
- › Unwanted liquids that have entered can be removed by extracting air during no-load operation.
- › To ensure sufficient cooling for the vacuum pump, the ventilation slits on the housing must not be covered.
- › Only use original replacement parts for maintenance to ensure that the device works reliably.
- › Watch out for water condensation inside and outside the device. Warm up the device first, if it has been brought in from a cold environment.
- › Never fasten the vacuum pump over a heating bath.
- › Ensure that no solids and/or liquids can enter the diaphragm of the vacuum pump through the suction line of the pump. This damages the diaphragm and other internal parts of the pump. This reduces delivery capacity and the final pressure can no longer be achieved. Deposits may be produced in the interior, reducing service life and causing leaks.

/// Accessories

- › Protect the device and accessories from bumps and impacts.
- › Check the device and accessories for damage before each use. Do not use damaged components.
- › Safe operation is guaranteed only with the use of original IKA accessories.
- › Always disconnect the plug before attaching accessories.
- › Observe the operating instructions of the accessories.
- › Elastic elements may be pressed together under vacuum.
- › Only use flexible hose lines.

/// Power supply / Switching off the device

- › The voltage stated on the type plate must correspond to the power voltage.
- › The device can only be disconnected from the power supply by pulling out the power plug or the connector plug.
- › The device must only be operated with the original power cord set.
- › The socket for the power cord must be easily accessible.
- › Socket must be earthed (protective ground contact).

/// Maintenance

- › The device must only be opened by trained specialists, even during repair. The device must be unplugged from the power supply before opening. Live parts inside the device may still be live for some time after unplugging from the power supply.

/// Disposal instructions

- › The device, accessories and packaging must be disposed of in accordance with local and national regulations.



Intended use

/// Use

⚠ Warning!

- › The device must not be used for:
 - evacuating biological habitats,
 - evacuating explosive, corrosive or similar gases,
 - throughput / use of liquids.
- › The device is not suitable for:
 - pumping up objects,
 - pumping liquids,
 - use in potentially explosive atmospheres,
 - underwater,
 - underground.

The laboratory diaphragm vacuum pump IKA VACSTAR lite is used together with other laboratory devices to create a vacuum.

For specific vacuum control, an additional vacuum controller IKA VC 10 lite / pro or IKA rotary evaporator RV 10 auto is required.

Standalone operation

The vacuum pump can be operated without a controller.

The pump can only run at a fix speed if it is not connected to the controller (e.g. VC 10 lite / pro or RV 10 auto). The pump will go into the energy-saving mode after running continuously for 1 hour. The final pressure is not controlled.

Operation with accessories

Along with the accessories recommended by IKA, the vacuum pump is suitable for controlled evacuation to a specified final pressure e.g. for operating an IKA rotary evaporator.

It can also be used for classical separation, filtration or drying in the laboratory.

With an appropriate vacuum controller (e.g. VC 10 lite / pro) or with a rotary evaporator (e.g. RV 10 auto), the VACSTAR lite can be operated automatically, for automatic boiling point detection, scheduled pressure-time curves or programs from the solvent library, for example.

Intended use: Tabletop device

/// Area of use

- › Indoor environments similar to that a laboratory of research, teaching, trade or industry area.
- › The safety of the user cannot be guaranteed:
 - if the device is operated with accessories that are not supplied or recommended by the manufacturer,
 - if the device is operated improperly or contrary to the manufacture's specifications,
 - if the device or the printed circuit board are modified by third parties.

Unpacking



/// Unpacking

- › Unpack the device carefully. Any damage should immediately be reported to the carrier (mail, rail or freight forwarding company).

/// Scope of delivery

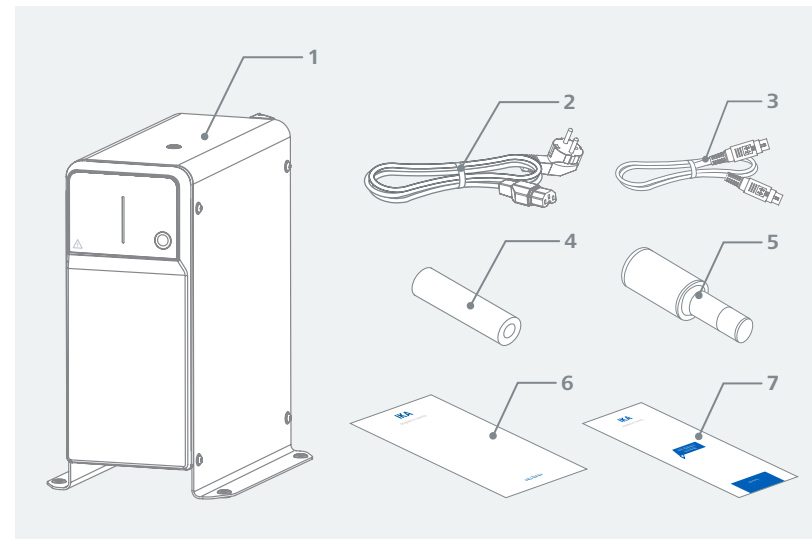

1	VACSTAR lite	5	Silencer
2	Power cord set	6	User guide
3	Connecting cable	7	Warranty card
4	Vacuum hose, 1 m		

Useful information

⊗ Danger!

You can prevent the release of solvent vapours into the atmosphere using a downstream emission condenser.

⊗ Caution!

Special care must be taken when working with gas mixtures that include condensable gases (e.g. solvents). If diaphragm pumps are used with such gases they condense in the pump's air flow. This leads to a build-up of pressure in the vacuum chamber, which in turn influences the effectiveness and service life of the diaphragms and valves.

If liquid or condensate enters the vacuum chambers, the specified minimum working pressure is no longer achieved.

To protect the inner valves and diaphragms against liquid, use an upstream condensate separator, such as a Woulff bottle.

It is generally recommended that you run the pump with no load at the end of the process (no-load operation, approx. 3 up to max. 5 minutes) to dispel any residues in the pump.

If applicable, vent the recipient.

To do this, remove the suction line during manual operation.

⚠ Notice!

Observe the operating instructions of the relevant devices.

Diaphragm vacuum pumps are oscillating displacement pumps. The diaphragms expand the volume of the vacuum chamber to produce an under pressure, which sucks air into the chamber. The air is then pressed out of the vacuum chamber by subsequent compression. Changes between the inlet and outlet are controlled by diaphragm valves.

The physical unit for pressure is 1 Pascal [Pa].

However people often still use the unit millibar [mbar] colloquially.

1 mbar = 100 Pa

1 bar = 10^5 Pa

1 Pa = 10^{-5} bar

1 Pa = 0.01 mbar

A distinction is made between different ranges in vacuum technology.

Rough vacuum: 10^5 to 10^2 Pa (1000 to 1 mbar)

Fine vacuum: 10^2 to 10^{-1} Pa (1 to 10^{-3} mbar)

High vacuum: 10^{-1} to 10^{-5} Pa (10^{-3} to 10^{-7} mbar)

Ultra high vacuum < 10^{-5} Pa (< 10^{-7} mbar)

The periodic movements of the diaphragms create a vacuum at the pump inlet. Diaphragm vacuum pumps work with a rough vacuum of up to 10^2 Pa. Lower pressures cannot be achieved with these pumps.

To create fine, high and ultra high vacuums, oil-sealed vacuum pumps, screw pumps, diffusion pumps or turbomolecular pumps must be used, for example. Diaphragm vacuum pumps are often used as pumps for the preliminary stage in these contexts.

Compressing and releasing the pressure on air creates a noise. The pump is quieter the less air is transported. This means that there is less operating noise during normal operation if the pressure is reduced.

A fitted exhaust hose with a sound absorber can also be used to reduce noise.

In automatic operation with controlled speed the pump reduces its speed when it reaches the target value. If the leakage rate in the entire system is low enough, the speed may even be set to "zero".

When combined with the vacuum controller VC 10 lite / pro or the rotary evaporator with integrated vacuum controller RV 10 auto, the pump can also be used for "two-position control" (valve-controlled) or "analogue speed control" of the vacuum.

Two-position control

When the target value is reached, the suction line is interrupted. Due to the small delay between the times when the pressure value is detected, when comparison is made with the target value, when a vacuum valve is switched off and when the suction line of the vacuum-producing system are switched off, it is easy to go below the set target value. If the pressure in the system goes up again due to a natural leakage rate, the suction line valve opens.

Schematic view of two-position vacuum control

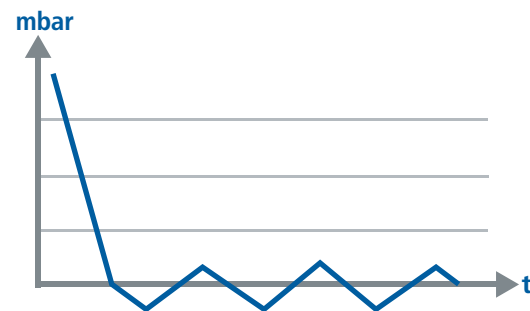

Analogue speed control

With this control, the speed of the pump, and therefore its suction power, is reduced the closer the measured pressure reaches the target value. Once the target value is reached, the pump only operates according to the leakage rate of the system. This enables quiet functioning, precise vacuum control and a long service life for the moving pump parts. Exact automatic boiling point recognition is possible with this type of control, meaning that the system reaches and keeps the solvent at its boiling point in automatic mode.

Schematic view of speed vacuum control

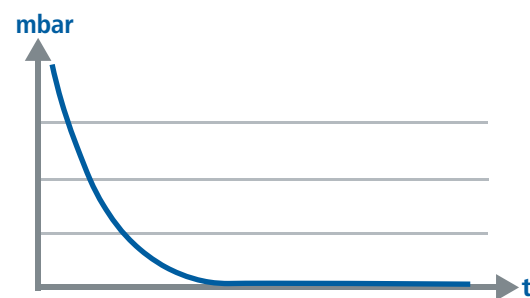

Operator panel and display

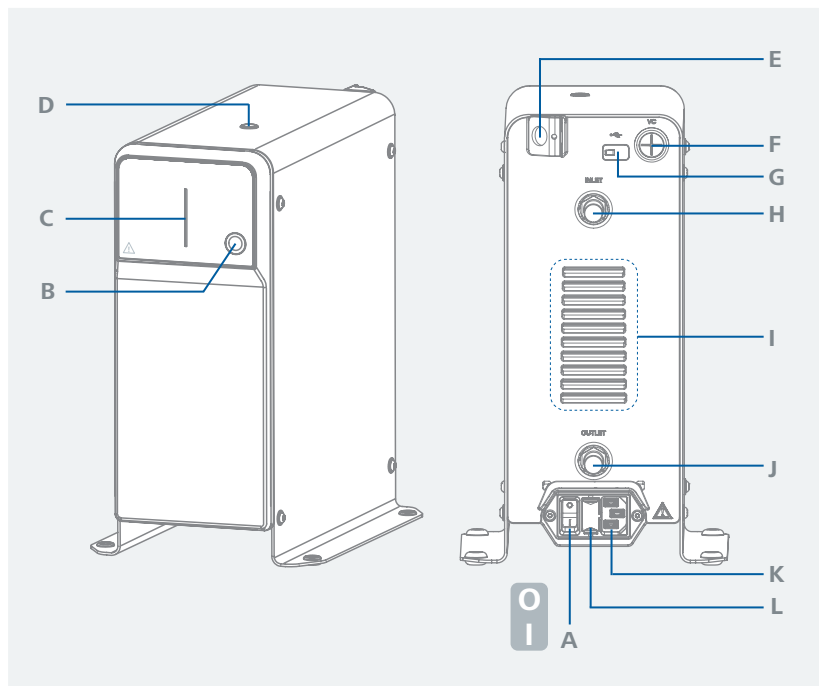

A	Power switch ("O" « off, "I" « on)	G	USB Interface
B	Start / stop button	H	Hose connection for suction line d = 8 mm (INLET)
C	LED bar	I	Ventilation slit
D	Mounting thread for VC 10.600 Stand pole	J	Hose connection for pressure line d = 8 mm (OUTLET)
E	Connection for VSE 1	K	Power socket
F	Connection for vacuum controller VC 10 lite / pro or rotary evaporator RV 10 auto (Mini DIN)	L	Fuse

Installation



Notice!

- › Ensure that you follow the general rule, that the recipient (load / vacuum container/glass condenser) should always be connected to the suction line at its highest point. This reduces the risk of liquids entering the pump.
- › Liquid in the pump chambers makes the pump properties worse.
- › Connect the hose connections (INLET / OUTLET) and interfaces in accordance with the labelling on the pump and the operating instructions.

- › The connections are barbed hose connectors. Ensure that the hoses have hose clips if applicable.
- › Lay the hoses in such a way that no condensate can flow into the pump.
- › Ensure that the air can enter the ventilation slit unhindered.
- › Install a condensate separator (e.g. a Woulff bottle) in the suction line before the intake spigot of the pump to protect against solvent coming in.
- › If solvent vapours are sucked in, an emission condenser (accessory) after the pump helps to condense it, and prevents it being released into the atmosphere.

/// Connection of interfaces

Notice!

- › Observe the relevant connections (see "Operator panel and display").

OUTLET: Hose connection d = 8 mm

You can link this connection to the emission condenser (accessory) with a vacuum hose, or fit a sound absorber to the end.

Notice!

- › Put the end of the hose in the extractor hood!
- › Check there is a free outlet on the pressurised side!
- › Do not use a throttle on the pressurised side and do not close the outlet! Connect the exhaust line to this connection.

Connection of vacuum controller VC 10 lite / pro or rotary evaporator RV 10 auto via Mini DIN

You can connect the vacuum pump and the vacuum controller VC 10 lite / pro or the rotary evaporator RV 10 auto with the analogue connection cable for precise speed-controlled vacuum control.

The vacuum controller detects the pump and switches to speed-vacuum control mode. Two-position control is deactivated.

USB interface

Connect the vacuum pump to a PC with a USB A - USB C cable. Any device software updates can be loaded using the IKA Firmware-Update-Tool.

INLET: Hose connection for suction line d = 8 mm

Connect the suction line to this connection.

Link this connection to the recipient (rotary evaporator condenser, laboratory reactor etc.) with a vacuum hose.

Power supply cable connection

Check that the voltage information on the rating plate matches your mains supply. Connect the power supply cable to supply electricity.

Notice!

Observe the operating instructions for the devices.

Automatic setting of the operating mode “Speed regulation” as soon as the analogue connecting cable connects the pump with the vacuum controller or rotary evaporator.

When the target value is reached, the pump speed will then be regulated automatically to maintain at desired pressure. Once the target value is reached, the pump applies suction according to the leakage rate of the vacuum system. Automatic boiling point recognition is possible.

1	Recipient (load, e.g. rotary evaporator, reactor)
2	Vacuum separator (e.g. Wouloff bottle)
3	Vent valve
4	Pressure sensor
5	Vacuum valve / ball valve
6	Emission condenser
7	Analogue connecting cable

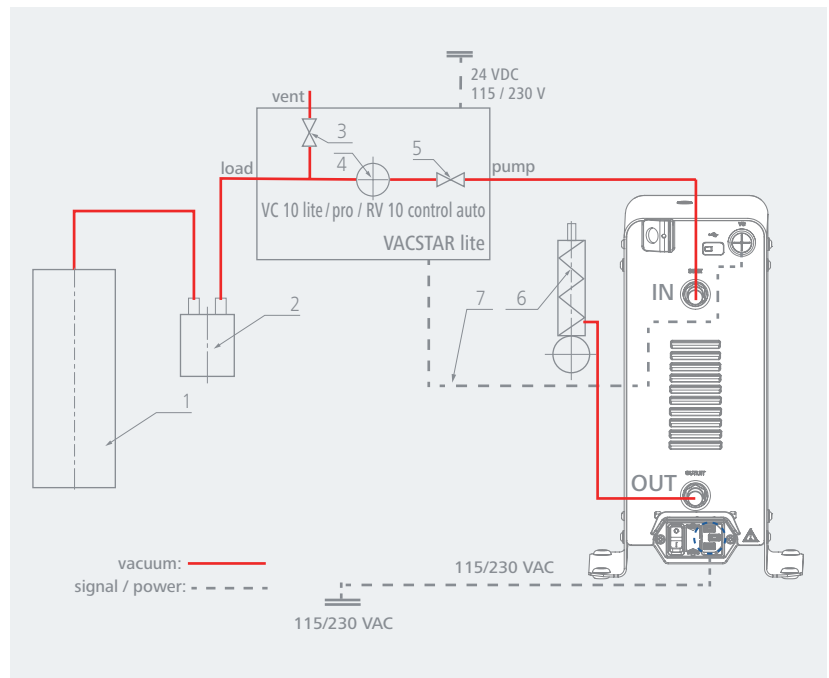

Operation



/// Switching on

Switch the device using the power switch. The LED bar lights up static green, indicating that the pump is in standby mode.

- › To start the pump, press the start / stop button. The pump starts to run and the LED bar pulsates in green.
- › You can stop the pump by pressing the start / stop button again. In this case, the pump returns to standby mode.
- › If the pump is operated with the vacuum controller VC 10 lite / pro or the rotary evaporator via the analog connection cable or is connected to labworldsoft® via the USB cable, the LED bar will light up static yellow.

/// Switching off

- › Switch off the device using the power switch.

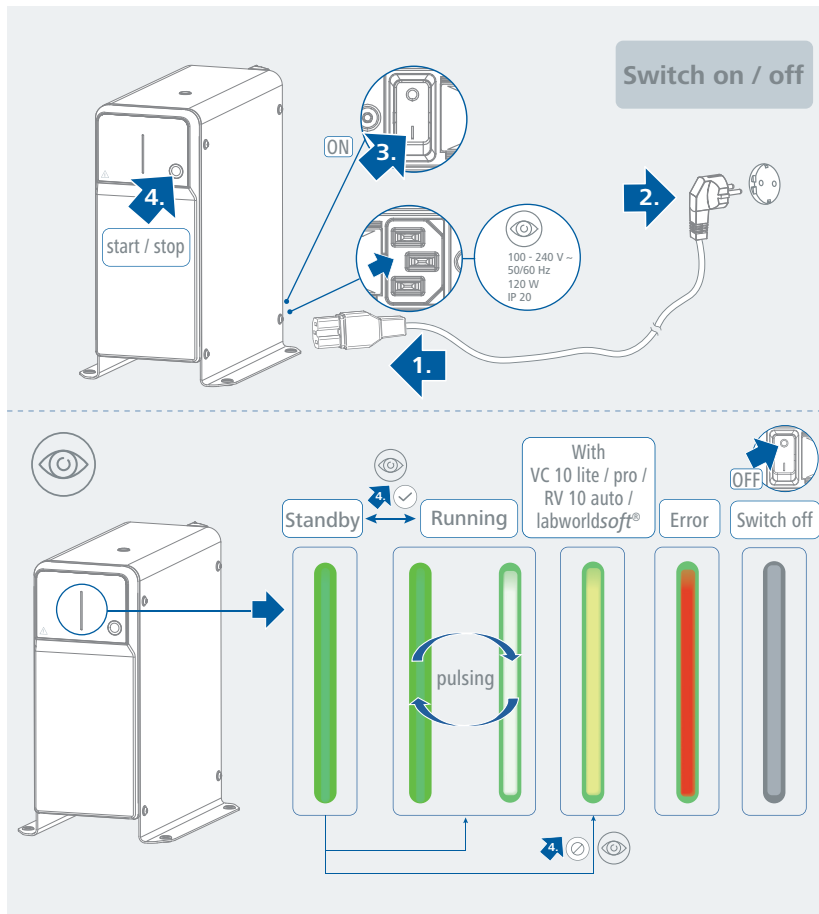

Interfaces and outputs

The device can be operated by computer via an USB interface using the laboratory software labworldsoft®.

The device software can also be updated with a PC via the USB port.

Notice!

Please comply with the system requirements together with the operating instructions and help section included with the software.

/// USB interface:

The connected devices and their properties are detected automatically. The USB interface is used in conjunction with software control for “remote” operation and can also be used for software update of the device.

/// USB device drivers:

First, download the latest driver for IKA devices with USB interface from:

<http://www.ika.com/ika/lws/download/usb-driver.zip>

Install the driver by running the setup file. Connect the IKA device through the USB data cable to the PC. The data communication runs through a virtual COM port.

Note: The USB driver is unnecessary for Windows 10 system. Don't install it for Windows 10 system!

/// Command syntax and format:

The following applies to the command set:

- › Commands are generally sent from the computer (Leader) to the device (Follower).
- › The device sends only at the computer's request. Even fault indications cannot be sent spontaneously from the device to the computer (automation system).
- › Commands are transmitted in capital letters.
- › Commands and parameters including successive parameters are separated by at least one space (Code: hex 0x20).
- › Each individual command (incl. parameters and data) and each response are terminated with Blank CR LF (Code: hex 0x20 hex 0x0d hex 0x0A) and have a maximum length of 50 characters.
- › The decimal separator in a number is a dot (Code: hex 0x2E).

The above details correspond as far as possible to the recommendations of the NAMUR working party (NAMUR recommendations for the design of electrical plug connections for analogue and digital signal transmission on individual items of laboratory control equipment, rev. 1.1).

The NAMUR commands and the additional specific IKA commands commissioning serve only as low level commands for communication between the device and the PC. With a suitable terminal or communications program these commands can be transmitted directly to the device. The IKA software package, Labworldsoft®, provides a convenient tool for controlling device and collecting data under MS Windows, and includes graphical entry features, for motor speed ramps for example.

NAMUR Commands	Function
IN_NAME	Read the device name
IN_PV_4	Read the actual speed value
IN_SP_4	Read the set speed value
OUT_SP_4	Adjust the set speed value
START_4	Start the evacuation
STOP_4	Stop the evacuation
RESET	Switch to normal operating mode
OUT_NAME	Set device name
OUT_SP_42@n	Setting WD safety limit speed with set value echo
OUT_WD1@m	Watchdog mode 1
OUT_WD2@m	Watchdog mode 2
IN_ERR	Error Status

“Watchdog” functions, monitoring of the serial data flow:

If, once this function has been activated (see NAMUR commands), there is no retransmission of the command from the computer within the set time (“watchdog time”), the evacuation function is switched off in accordance with the set “watchdog” function or are changed to the set target values.

The data transmission may be interrupted by, for example, a crash in the operating system, a power failure in the PC or an issue with the connection cable between the computer and the device.

“Watchdog” – mode 1:

If event WD1 should occur, the evacuation function is switched off and PC1 will be returned when IN_ERR is sent. Set watchdog time to m (20 - 1500) seconds, with watchdog time echo. This command launches the watchdog function and must be transmitted within the set watchdog time.

“Watchdog” – mode 2:

If there is an interruption in data communications (longer than the set watchdog time), the speed target value is changed to the set WD safety speed limit. PC2 will be returned when IN_ERR is sent. The WD2 event can be reset with OUT_WD2@0 - this also stops the watchdog function. Set watchdog time to m (20 - 1500) seconds, with watchdog time echo. This command launches the watchdog function and must be transmitted within the set watchdog time.

/// Connections between device and external devices

USB cable A – C:

This cable is required to connect USB port to a PC.

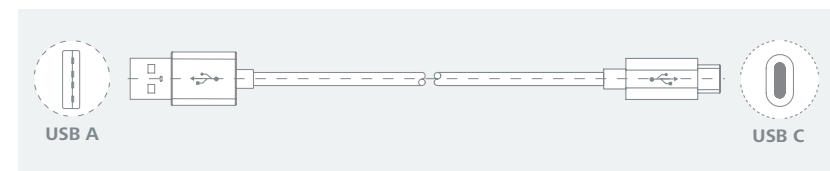

Connecting cable:

This cable is required to connect VC 10 lite / pro to RV 10 auto with the diaphragm vacuum pump VACSTAR lite.

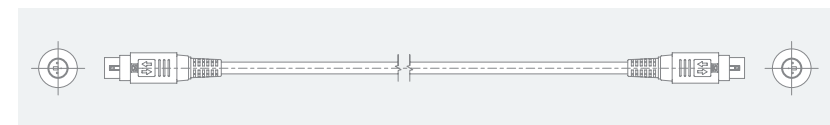

Maintenance and cleaning

- › The device is maintenance-free. It is only subject to the natural wear and tear of components and their statistical failure rate.

/// Cleaning

- › For cleaning disconnect the mains plug!
- › Use only cleaning agents which have been approved by IKA to clean the devices: Water containing surfactant / isopropyl alcohol.
- › Wear protective gloves during cleaning the devices.
- › Electrical devices may not be placed in the cleansing agent for the purpose of cleaning.
- › Do not allow moisture to get into the device when cleaning.
- › Before using another than the recommended method for cleaning or decontamination, the user must ascertain with IKA that this method does not destroy the device.

/// Ordering spare parts

- › When ordering spare parts, please give:
 - device type.
 - serial number, see type plate.
 - position number and description of spare part, see www.ika.com.

/// Repairs

- › Please only send devices in for repair that have been cleaned and are free of materials which might present health hazards.
- › For repair, please request the “**Safety Declaration (Decontamination Certificate)**” from IKA or use the downloaded printout of it from IKA website at www.ika.com.
- › If your appliance requires repair, return it in its original packaging. Storage packaging is not sufficient when sending the device - also use appropriate transport packaging.

Accessories

- › For accessories see www.ika.com.

Material of parts in contact with medium

Connection spigot	PPS	Diaphragm valve	FFPM
Connection piece	PPS	Diaphragm	NBR / PTFE
Distributor	PPS	Clamp	PPS
Head piece	PPS		

Error codes

- › If an error occurs, the display light bar will be shown in red. The error code can be read via USB using IN_ERR command or labworldsoft®. Proceed as follows in such cases:
 - Turn off the device by using the power switch.
 - Carry out corrective measures.
 - Restart the device.

Error code | Causes | Effect | Solutions

E22273824

Causes	› Overheat
Effect	› The pump does not run
Solutions	› Switch off the pump, disconnect it from the mains, let it cool down.

E22240702

Causes	› Motor blocked / overload
Effect	› The pump does not run
Solutions	› Switch off the pump, disconnect it from the mains, let it cool down. › Ventilate the vacuum system to normal pressure.

E22243020

Causes	› Hall sensor defective
Effect	› The pump does not run
Solutions	› Service

E22546920

Causes	› BLP self-test / EEPROM error
Effect	› The pump does not run
Solutions	› Service

E22034115

Causes	› Connection problem
Effect	› The pump does not run
Solutions	› Service: check the motor cable connection

- › If the actions described fails to resolve the fault or another error code is displayed then take one of the following steps:
 - contact the service department.
 - send the device for repair, including a short description of the fault.



Technical data

Pump rate max. (50/60 Hz)	m³/h	1.0
Pump rate max. (50/60Hz)	l/min	16.67
Final pressure	mbar	9
Suction levels		2
Cylinder		2
Connection diameter suction side	mm	8
Connection diameter pressure side	mm	8
Input pressure	mbar	10 ... 1030
Analog speed-vacuum control		yes
Speed range	rpm	285 ... 1100 (With controller)
Noise at low pressure	dB(A)	54
Material in contact with medium		Al ₂ O ₃ , PTFE, FFPM, PPS, NBR
Housing material		alu-cast coating / thermoplastic polymer
Dimensions (W x D x H)	mm	115 x 280 x 292
Weight	kg	8.5
Permissible ambient temperature	°C	+ 5 ... + 40
Permissible relative humidity		80% (up to 31 °C), decreasing linearly to max. 50% (@40 °C)
Protection class according to DIN EN 60529		IP 20
USB interface		yes
Voltage	V	100 ... 240
Frequency	Hz	50 / 60
Power input	W	120
Power input standby	W	1.5
Fuse		2x T4A 250 V
Protection class		I
Overvoltage category		II
Contamination level		2
Operation at a terrestrial altitude	m	2000
Firmware update		yes

Subject to technical changes!

Warranty

- › In accordance with IKA Terms and Conditions of Sale, the warranty period is 24 months. For claims under the warranty please contact your local dealer. You may also send the device direct to our factory, enclosing the delivery invoice and giving reasons for the claim. You will be liable for freight costs.
- › The warranty does not cover worn out parts, nor does it apply to faults resulting from improper use, insufficient care or maintenance not carried out in accordance with the instructions in this operating instructions.



designed for scientists

IKA-Werke GmbH & Co. KG

Janke & Kunkel-Straße 10,
79219 Staufen, Germany
Phone: +49 7633 831-0
eMail: sales@ika.de

USA

IKA Works, Inc.
Phone: +1 910 452-7059
eMail: sales@ika.net

KOREA

IKA Korea Ltd.
Phone: +82 2 2136 6800
eMail: sales-lab@ika.kr

BRAZIL

IKA Brasil
Phone: +55 19 3772 9600
eMail: sales@ika.net.br

MALAYSIA

IKA Works (Asia) Sdn Bhd
Phone: +60 3 6099-5666
eMail: sales.lab@ika.my

CHINA

IKA Works Guangzhou
Phone: +86 20 8222 6771
eMail: info@ika.cn

POLAND

IKA Poland Sp. z o.o.
Phone: +48 22 201 99 79
eMail: sales.poland@ika.com

JAPAN

IKA Japan K.K.
Phone: +81 6 6730 6781
eMail: info_japan@ika.ne.jp

INDIA

IKA India Private Limited
Phone: +91 80 26253 900
eMail: info@ika.in

UNITED KINGDOM

IKA England LTD.
Phone: +44 1865 986 162
eMail: sales.England@ika.com

VIETNAM

IKA Vietnam Company Limited
Phone: +84 28 38202142
eMail: sales.lab-vietnam@ika.com

THAILAND

IKA Works (Thailand) Co. Ltd.
Phone: +66 2059 4690
eMail: sales.lab-thailand@ika.com

TURKEY

IKA Turkey A.Ş.
Phone: +90 216 394 43 43
eMail: sales.turkey@ika.com

KENYA

IKA Works Kenya Ltd.
Phone: +254 112 323 745
eMail: sales.kenya@ika.com

UGANDA

IKA Works Kampala Limited
Phone: +254 112 323 745
eMail: sales.uganda@ika.com

SPAIN

IKA Works Spain, S. L.
Barcelona
eMail: sales.spain@ika.com

Register now: www.ika.com/register



www.ika.com



IKAworlwide // #lookattheblue

Technical specifications may be changed without prior notice.