

IKA

designed for scientists

IKA G-L

ENGLISH

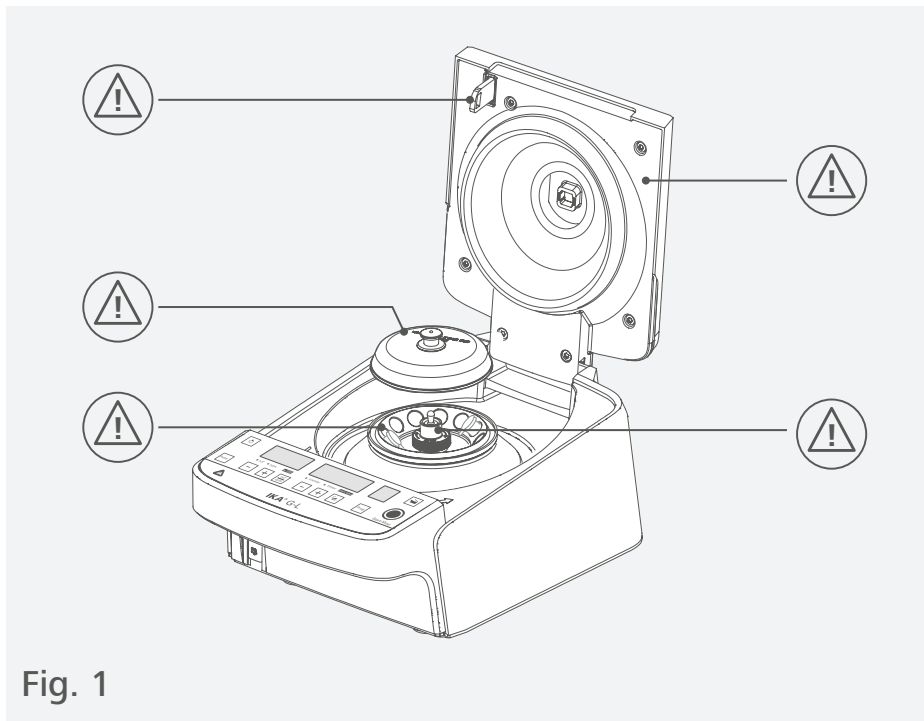









Fig. 1

	EU Declaration of conformity	6
	Explication of warning symbols	6
	Safety instructions.....	7
	Intended use.....	9
	Unpacking	10
	Operator panel and display	11
	Installation.....	12
	Operation	14
	Error codes and troubleshooting	20
	Maintenance and cleaning.....	23
	Interfaces and outputs	24
	Accessories	25
	Technical Data	26
	Warranty	27



EU Declaration of conformity

We declare under our sole responsibility that this product corresponds to the directives 2014/35/EU, 2006/42/EC, 2014/30/EU and 2011/65/EU and conforms with the following standards or normative documents: EN 61010-1, EN 61010-2-020, EN 60529, EN 61326-1 and EN ISO 12100.

A copy of the complete EU Declaration of conformity can be requested at sales@ika.com.



Explication of warning symbols

/// Warning symbols



Danger!

Indicates an (extremely) hazardous situation, which, if not avoided, will result in death, serious injury.



Warning!

Indicates a hazardous situation, which, if not avoided, can result in death, serious injury.



Caution!

Indicates a potentially hazardous situation, which, if not avoided, can result in injury.



Notice!

Indicates practices which, if not avoided, can result in equipment damage.

/// General Symbols

A — Position number



Correct/Result

Shows the correct execution or the result of an action step.



Wrong

Shows the incorrect execution of an action step.



Note

Displays action steps that require particular attention to detail.



Beep

Shows action steps where audible beeps can be heard.

Safety instructions



/// General information

- › **Read the operating instructions completely before starting up and follow the safety instructions.**
- › Keep the operating instructions in a place where it can be accessed by everyone.
- › Ensure that only trained staff work with the device.
- › Follow the safety instructions, guidelines, occupational health and safety and accident prevention regulations.
- › The device must only be used in a technically perfect condition.

Caution!

- › Wear your personal protective equipment in accordance with the hazard category of the medium to be processed, there is a risk of:
 - splashing of liquids
 - body parts, hair, clothing and jewellery getting caught.

Notice!

- › Pay attention to the marked sites in Fig. 1.

/// Device setup

Caution!

- › The power switch of the device must be accessed immediately, directly and without risk at any time. If access to the power switch cannot be ensured, an additional emergency stop switch that can be easily accessed must be installed in the work area.

Notice!

- › Set up the device in a spacious area on an even, stable, clean, non-slip, dry and fireproof surface.
- › Make sure that the ventilation slits are not blocked at bottom and rear side of the device.
- › Always load the rotors symmetrically and ensure that no impermissible imbalances arise during centrifuging.

/// Working with the device

Danger!

- › Do not use the device in explosive atmospheres, it is not EX-protected.
- › With substances capable of forming an explosive mixture, appropriate safety measures must be applied, e.g. working under a fume hood.
- › To avoid body injury and property damage, observe the relevant safety and accident prevention measures when processing hazardous materials.
- › The device must be operated on a flat surface and must not be moved during operation.

Warning!

- › When centrifuging hazardous substances or mixtures of substances which are toxic or are contaminated with pathogenic micro-organisms, the user should take appropriate precautions. In such cases, centrifuging vessels with special screw seals for hazardous substances must always be used.
- › For materials in risk groups 3 and 4, in addition to sealed centrifuging vessels a bio-safety system must be used (see the "Laboratory Biosafety Manual" issued by the World Health Organisation). No biosafety systems are available for this centrifuge.

Notice!

- › Before starting the device for the first use, make sure that the rotor nut is securely fastened. Fail to do it, can result in permanent damage to the device and accessories.
- › The rotor is subjected to extreme forces. Serious internal material damage can occur as a result of even slight scratches and cracks. Do not use the device if the rotor is damaged.
- › Do not operate the centrifuge if there is evidence of damage to the centrifuge chamber.
- › Do not process materials that are radioactive, flammable or explosive, or materials that react chemically with each other releasing large amounts of energy.
- › If unusual noises occur when the centrifuge is started, the rotor is not secured correctly. In this case, immediately stop the centrifuge.
- › Covers or parts that can be removed from the device without tools must later be refitted to ensure safe operation. This will prevent the infiltration of foreign objects, liquids and other contaminants.
- › Prior to centrifugation, the tubes should be visually inspected for any physical damage. Broken tubes can damage centrifuge and accessories.
- › If you are using aggressive chemicals, protect the device from being damaged by these chemicals.
- › Only process media that will not react dangerously to the extra energy produced through processing. This also applies to any extra energy produced in other ways, e.g. through light irradiation.

- › Always use rotor cover along with the rotor.
- › Inspect the rotor and rotor cover regularly.
- › Do not run the motor without rotor.
- › The device must be supervised when it is running.
- › While the centrifuge is running, do not move it or strike it.
- › The feet of the device must be clean and undamaged.

/// Accessories

- › Protect the device and accessories from bumping and impacting.
- › Check the device and accessories beforehand for damage each time when you use them. Do not use damaged components.
- › Safe operation is only guaranteed with the accessories described in the "Accessories" section.
- › Disconnect the power plug before attaching or changing any accessories.

/// Power supply / switching off the device

- › The voltage stated on the type plate must correspond to the power voltage.
- › The device can only be disconnected from the power supply by pulling out the power plug or the connector plug.
- › The device must only be operated with the original power cord set.
- › The socket for the power cord must be easily accessible.
- › The device does not start up again automatically following a cut in the power supply.

/// Maintenance

- › The device must only be opened by trained specialists, even during repair. The device must be unplugged from the power supply before opening. Live parts inside the device may still be live for some time after unplugging from the power supply.

/// Disposal instructions

- › The device, accessories and packaging must be disposed of in accordance with local and national regulations.

Intended use

/// Use

- › The IKA G-L centrifuge is suitable for separating of substances and mixtures of substances of various densities.
- › **Intended use:** Tabletop device

/// Range of use

Indoor environments similar to that a laboratory of research, teaching, trade or industry.

The safety of the user cannot be guaranteed:

- › if the device is operated with accessories that are not supplied or recommended by the manufacturer.
- › if the device is operated improperly or contrary to the manufacture's specifications.
- › if the device or the printed circuit board are modified by third parties.





Unpacking

- › Please unpack the device carefully.
- › Any damage should be notified immediately to the shipping agent (post office, railway network or logistics company).

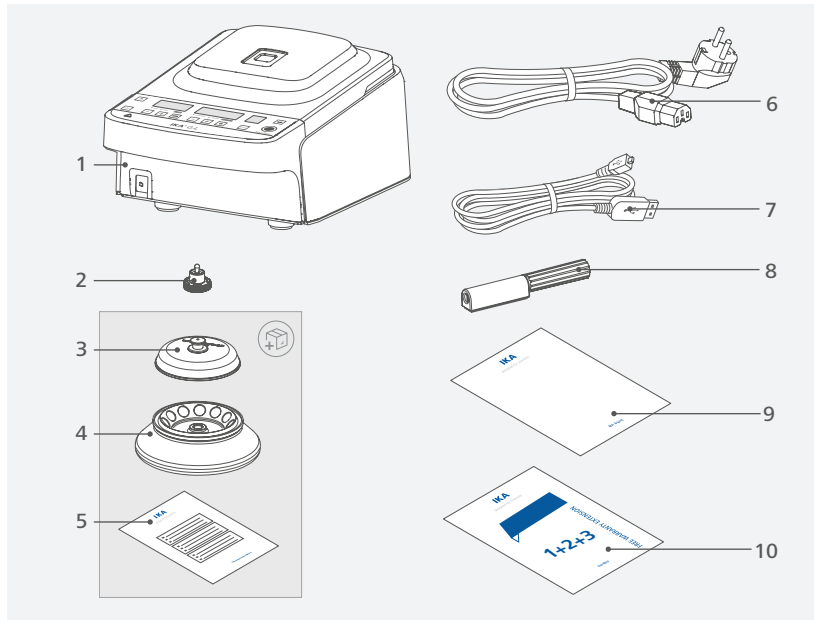

1	IKA G-L	7	USB cable
2	Rotor nut	8	Screwdriver (for opening the lid in emergency)
3	Rotor cover	9	User guide
4	Rotor IKA CR 12 x 2 ml	10	Warranty card
5	Technical information IKA G-L Rotors		
6	Power cord set		

Operator panel and display

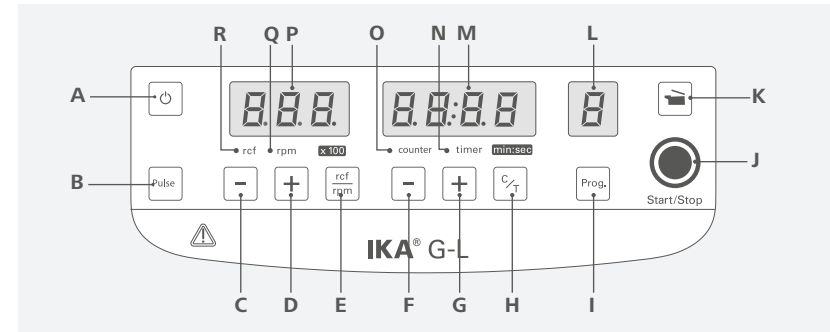

A	On/Off button	Switch on/off the device.
B	"Pulse" button	Short-term centrifuging (device runs at max. or set speed as long as the button (B) is kept pressing).
C	"rcf/rpm" (-) button	Decrease the "rcf/rpm" setting value.
D	"rcf/rpm" (+) button	Increase the "rcf/rpm" setting value.
E	"rcf/rpm" button	Switch between "rcf" and "rpm" function.
F	Timer (-) button	Decrease the timer setting value.
G	Timer (+) button	Increase the timer setting value.
H	"C/T" button	Switch between counter (C) and timer (T) function.
I	"Program (Prog.)" button	Select the program.
J	"Start/Stop" button	Start/stop to run the device.
K	Lid release button	Open the safety lid of the device.
L	Program number display	Display the selected program number.
M	"counter/timer" display	Display the counter/timer value.
N	"timer" indicator	Indicate the timer function is activated.
O	"counter" indicator	Indicate the counter function is activated.
P	"rcf/rpm" display	Display the "rcf/rpm" value.
Q	"rpm" indicator	Indicate the "rpm" function is activated.
R	"rcf" indicator	Indicate the "rcf" function is activated.



Installation

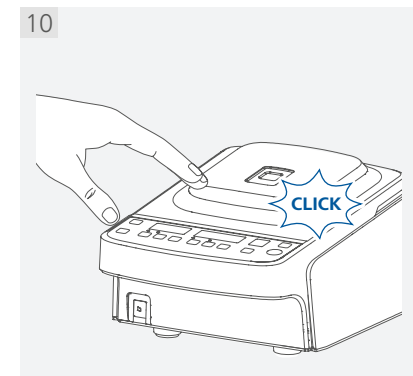
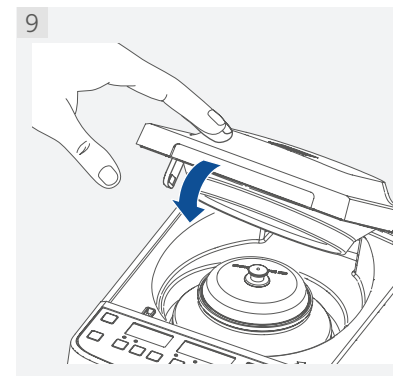
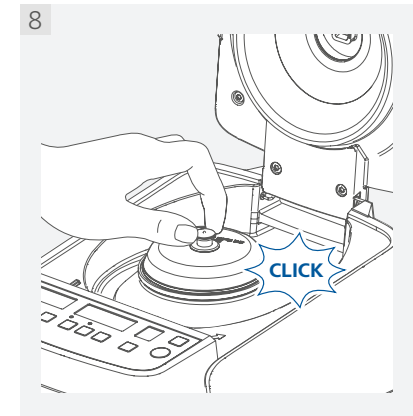
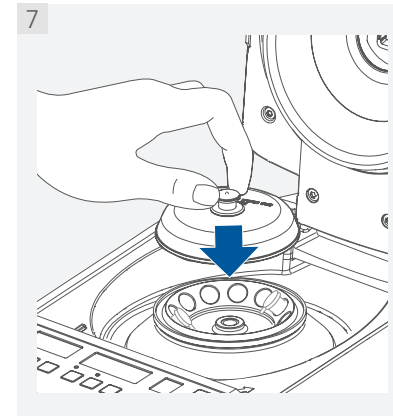
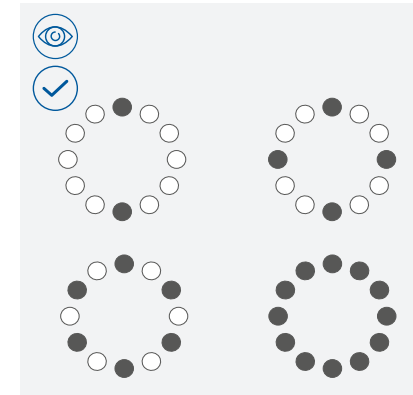
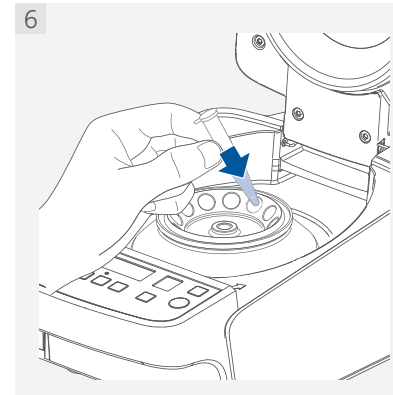
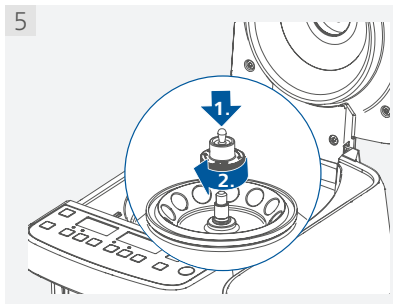
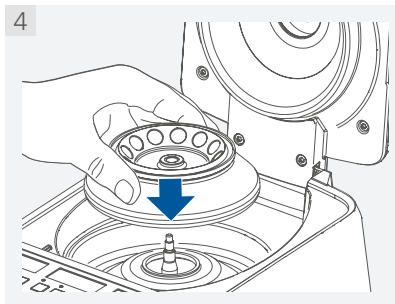
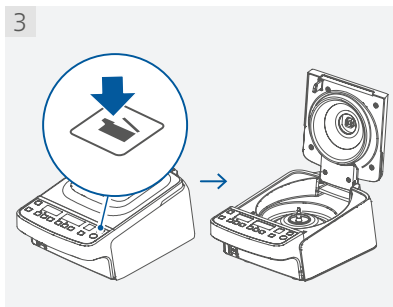
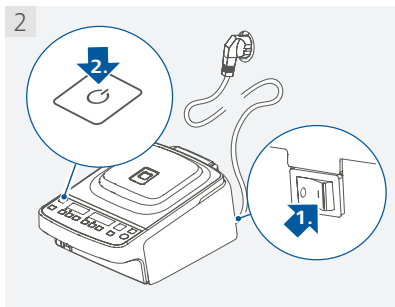
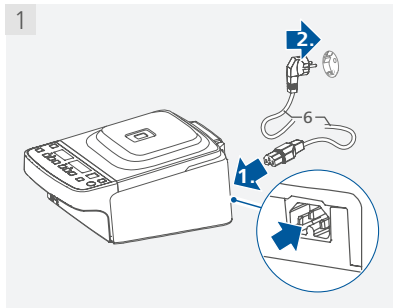
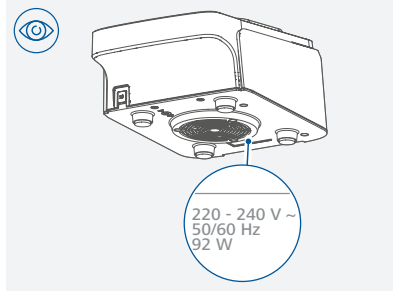
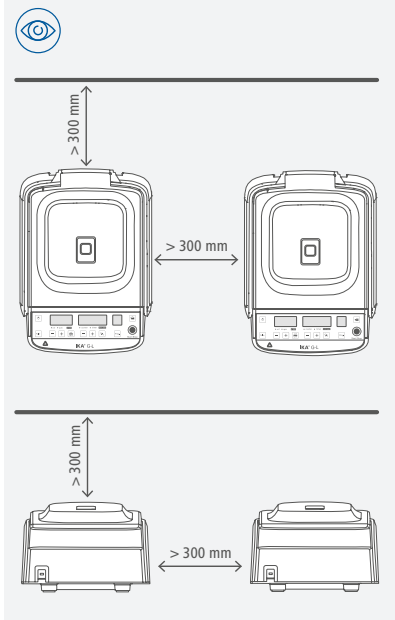



Operation

Switching between rcf and rpm / Setting rcf or rpm

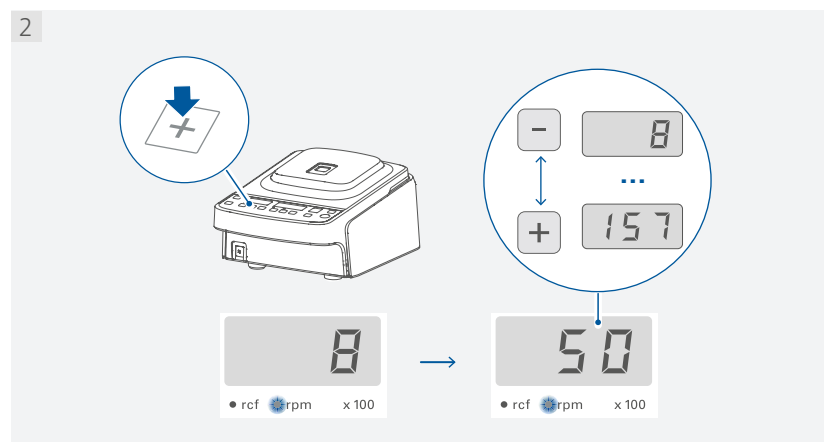
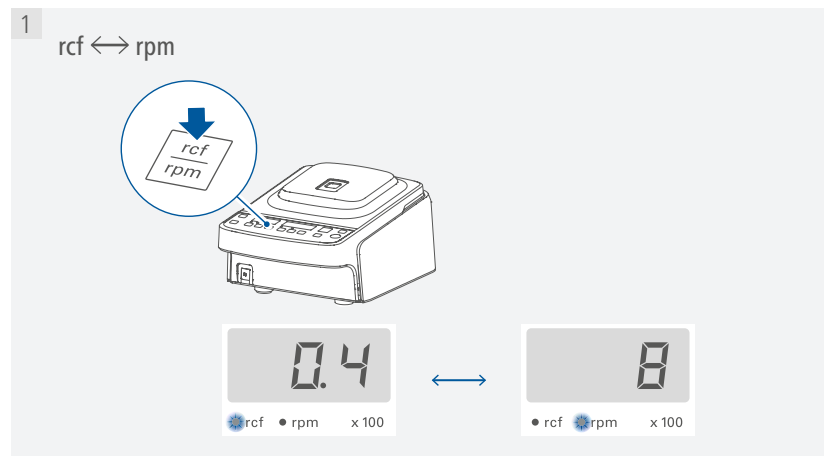

Switching between counter and timer / Setting timer

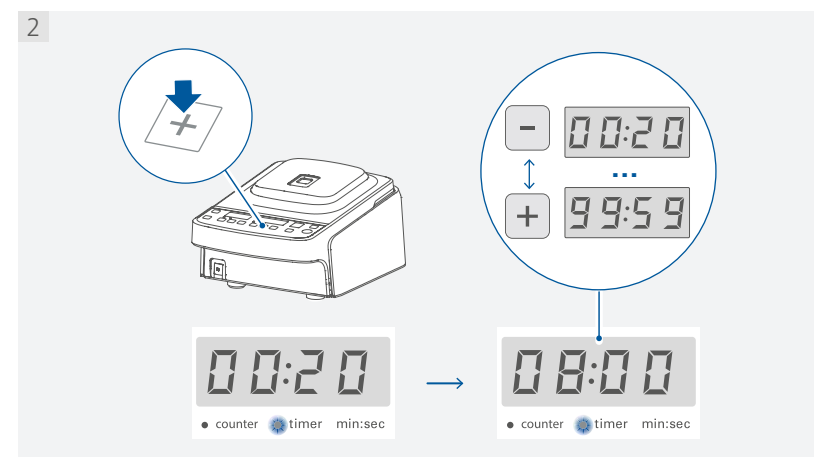
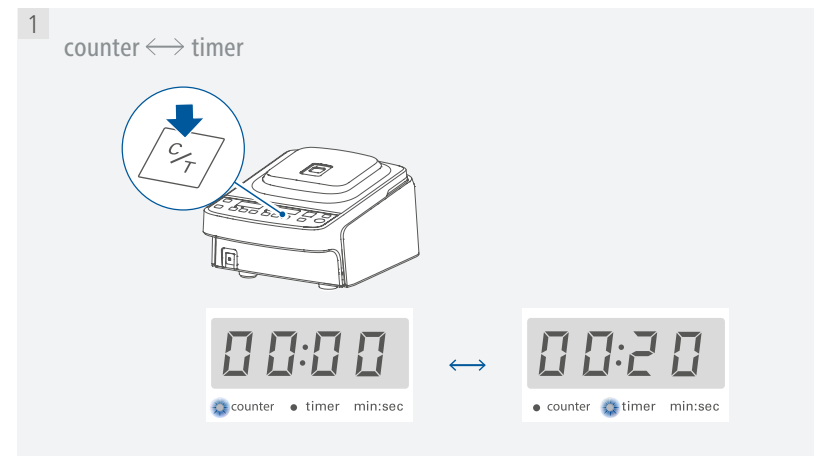

RCF (g-force) calculation in accordance with DIN 58970:

$$Rcf = 1.118 * 10^{-5} * n^2 * r_{max}$$

n: rotational speed in rpm

r_{max}: maximum centrifugation radius in cm

Example, The maximum centrifugation radius of the rotor IKA G-L CR 12x2ml is 6 cm. At a speed of 15700 rpm, a maximum g-force of 16500 x g can be achieved.

Centrifuging

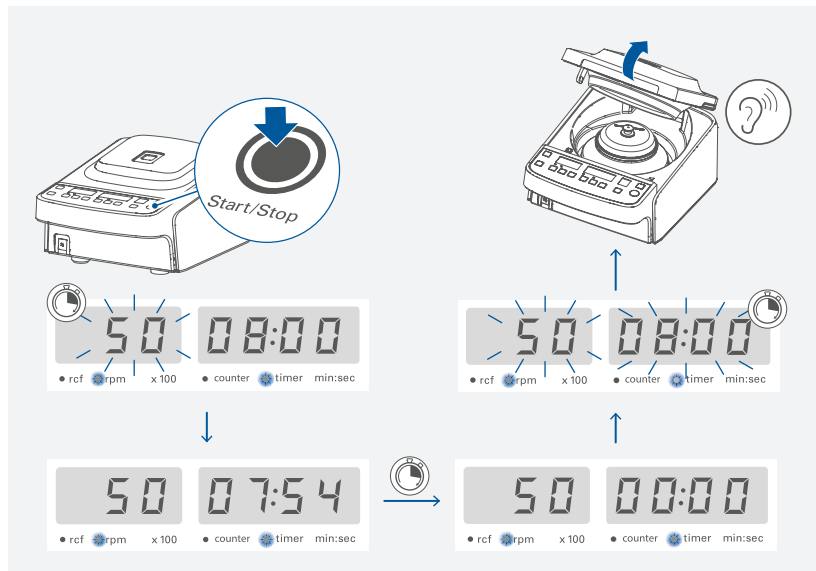

Pulse function

Setting max. (15700 rpm) / Preset speed for Pulse function:

- > Set the desired rpm with "rcf/rpm" (+) button(D) / "rcf/rpm" (-) button (C).
- > Open the lid by pressing lid release button (K).
- > Press and hold Pulse Button (B).
- > Toggle between max. speed (157) and set speed (SET) by long press on pulse button (B)
- > Close the lid.

Activating the Pulse function:

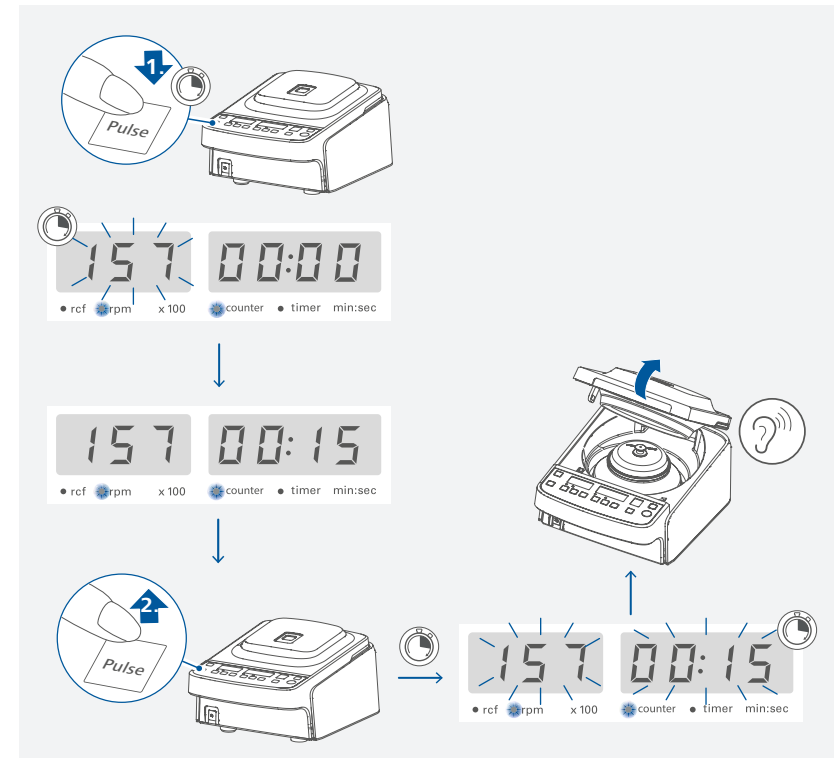

Editing the program

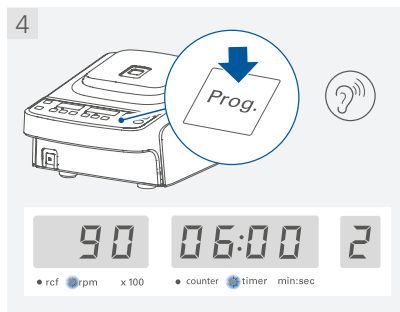
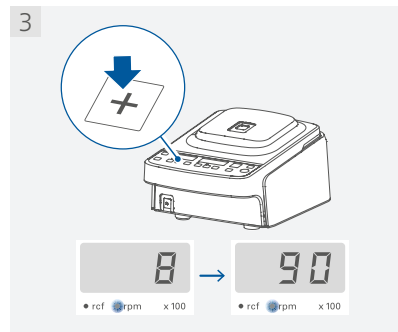
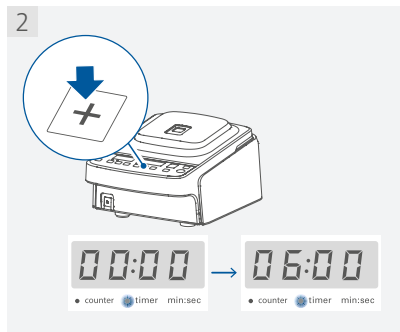
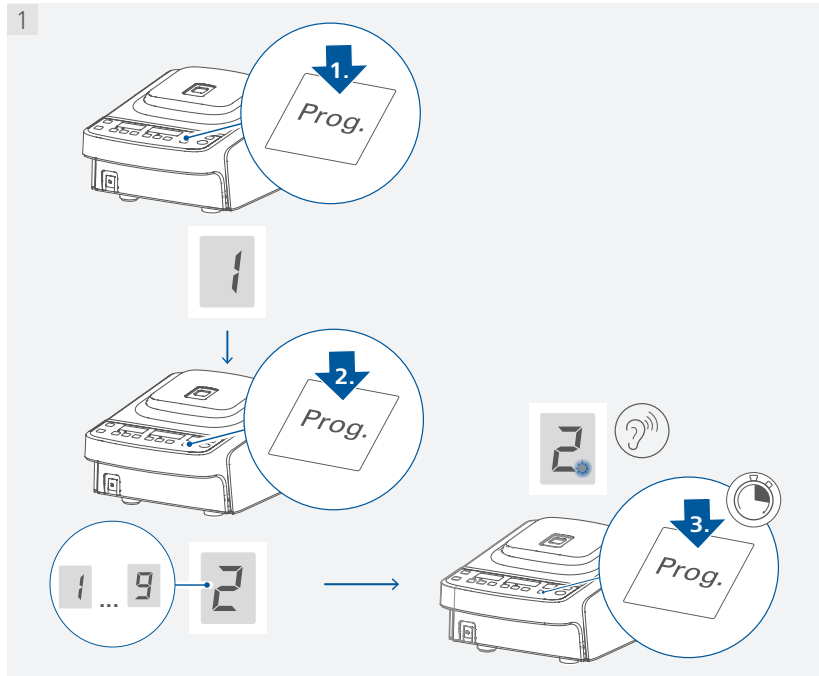

Activating the program

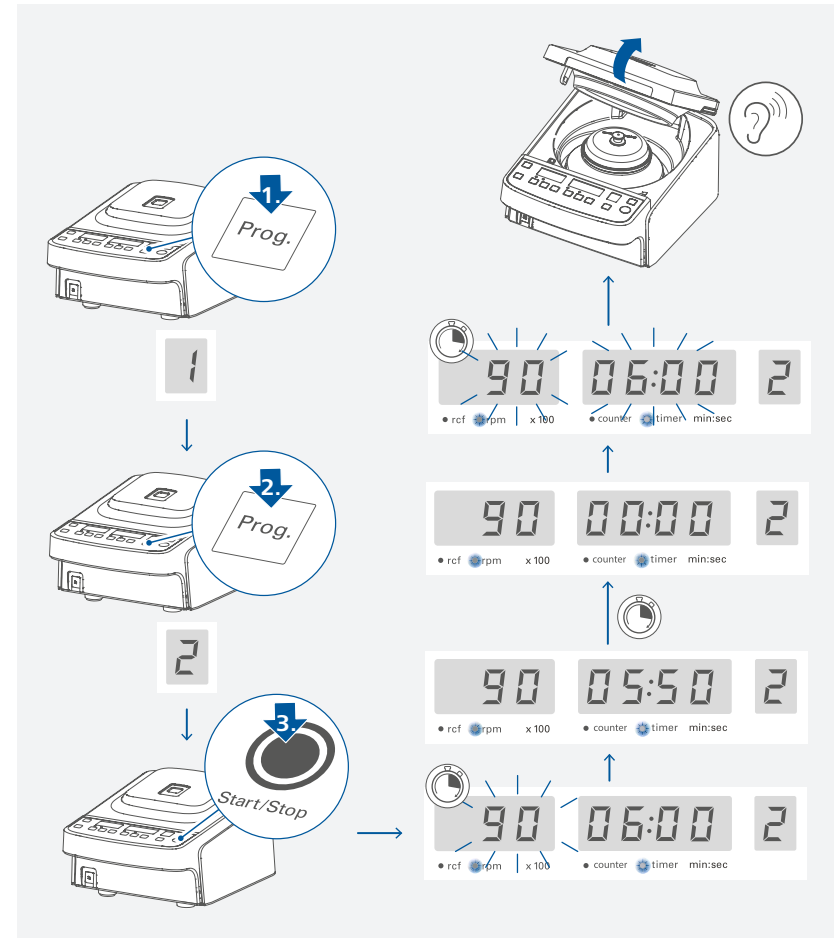

Error codes and troubleshooting

/// Error codes

Any malfunctions during operation will be identified by an error message on the display.

Proceed as follows in such cases:

- › Turn off the device by using the power switch.
- › Carry out corrective measures.
- › Switch on the device with the power switch (Error code will show again)
- › Press the On/Off button (Error code will disappear and the device is ready for use again)

E 2 (E 2)	
Causes	› USB connection lost.
Effect	› No communication between PC and device.
Solutions	› Switch off the device with the power switch and reconnect USB cable. › Restart the device by pressing power switch.
E 3, E 48, E 74 (E 3, E 48, E 74)	
Causes	› Temperature inside device is too high.
Effect	› Motor off
Solutions	› Switch off the device with the power switch and allow it to cool down. › Restart the device by pressing power switch.
E 72 (E 72)	
Causes	› Rotor nut is not attached, or not properly attached.
Effect	› Motor off
Solutions	› Switch off the device with the power switch and switch it on again. › Open the lid and check the rotor nut.
E 81 (E 81)	
Causes	› The lid sensor fault
Effect	› Motor off
Solutions	› Switch off the device and close the lid. › Restart the device by pressing power switch.
For all other error codes:	
Effect	› Motor off
Solutions	› Switch off the device with the power switch. › Restart the device by pressing power switch.

If the actions described fails to resolve the fault or another error code is displayed then take one of the following steps:

- › contact the service department.
- › send the device for repair, including a short description of the fault.

/// Warning/Note codes

unb	
Causes	› The load in the rotor is not balance
Effect	› Motor off
Solutions	› Switch off the device › Reload the rotor.
Int	
Causes	› Power voltage failure in short time during operating.
Effect	› Motor off
Solutions	› Wait until Int stops flashing. › Then switch off the device.
Lid	
Causes	› The lid is blocked or cannot be opened (after centrifuging).
Effect	› Motor cannot run
Solutions	› Make sure that nothing is on the top of the lid. › Press the lid release button several times. › If the lid will not open, see section "Emergency opening lid".
or	
Lid	
Causes	› The lid is not closed completely (before centrifuging).
Effect	› Motor cannot run
Solutions	› Push the lid down completely within 6 seconds (otherwise E 81 appears).
Open	
Causes	› The lid opens
Effect	› Motor cannot run
Solutions	› Close the lid
USB	
Causes	› The device is connected with a PC via USB port

/// Emergency opening lid

In an emergency, you can open the protective cover as described below:

- › Disconnect the device from the power source.
- › Make sure the rotor has come to a standstill.
- › Lift the device and open the protective cover by turning the mechanical latch in counterclockwise with the included screwdriver.

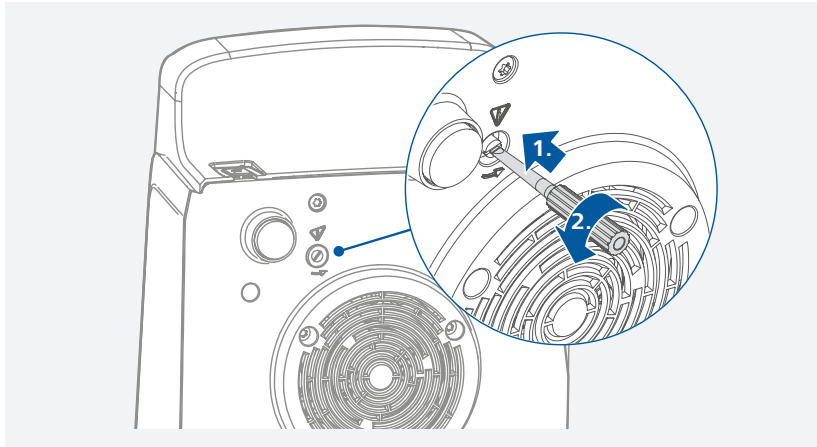

Caution!

When lifting up the device, particularly after a device failure, please note that the motor on the underside of the device can become very hot. Touch the device at the edges only! Please also take care of the samples inside the rotor. The samples may spill out while lifting the device.

Maintenance and cleaning

The device is maintenance-free. It is only subject to the natural wear and tear of components and their statistical failure rate.

/// Cleaning

For cleaning disconnect the mains plug!

Use only cleaning agents which have been approved by IKA to clean the devices:
These are: water (containing surfactant) and isopropyl alcohol.

- › Wear protective gloves during cleaning the devices.
- › Electrical devices may not be placed in the cleansing agent for the purpose of cleaning.
- › Do not allow moisture to get into the device when cleaning.
- › Before using another than the recommended method for cleaning or decontamination, the user must ascertain with that this method does not destroy the device.

/// Ordering spare parts

When ordering spare parts, please indicate:

- › Device type.
- › Serial number, see type plate
- › Item and designation of the spare part, see: www.ika.com, spare parts diagram and spare parts list.
- › Software version (Briefly visible in the display when the device is switched on).

/// Repairs

Please send in device for repair only after it has been cleaned and is free from any materials which may constitute a health hazard.

For repair, please request the "Decontamination Certificate" from **IKA**, or download printout of it from the **IKA** website www.ika.com.

If you require servicing, return the device in its original packaging. Storage packaging is not sufficient. Please also use suitable transport packaging.

Interfaces and outputs

The device can be connected to a PC and operated with the laboratory software labworldsoft® through USB interface.

Note: Please comply with the system requirements together with the operating instructions and help section included with the software.

/// USB interface

The Universal Serial Bus (USB) is a serial bus for connecting the device to the PC. Equipped with USB devices can be connected to a PC during operation (hot plugging).

Connected devices and their properties are automatically recognized.

Use the USB interface in conjunction with labworldsoft® for operation in "Remote" mode and also to update the firmware.

/// USB device drivers

First, download the latest driver for IKA devices with USB interface from:

www.ika.com/ika/lws/download/usb-driver.zip.

Install the driver by running the setup file. Connect the IKA device through the USB data cable to the PC. The data communication runs through a virtual COM port.

/// Command syntax and format

The following applies to the command set:

- › Commands are generally sent from the computer (Master) to the lab device (Slave).
- › The lab device only sends at the computer's request. Even fault indications cannot be sent spontaneously from the lab device to the computer (automation system).
- › Commands are transmitted in capital letters.
- › Commands and parameters including successive parameters are separated by at least one space (Code: hex 0x20).
- › Each individual command (incl. parameters and data) and each response are terminated with Blank CR LF (Code: hex 0x0d hex 0x0A) and have a maximum length of 80 characters.
- › The decimal separator in a number is a dot (Code: hex 0x2E).

The above details correspond as far as possible to the recommendations of the NAMUR working party (NAMUR recommendations for the design of electrical plug connections for analogue and digital signal transmission on individual items of laboratory control equipment, rev. 1.1).

The NAMUR commands and the additional specific IKA commands serve only as low level commands for communication between the device and the PC. With a suitable terminal or communications program these commands can be transmitted directly to the device. The IKA software labworldsoft®, provides a convenient tool for controlling the device and collecting data under MS Windows, and includes graphical entry features, for motor speed ramps for example.

Commands	Function
IN_NAME	Read the device name
IN_PV_4	Read current speed value
IN_SP_4	Read rate speed value
OUT_SP_4 xxx	Adjust the set speed value xxx
START_4	Start the motor
STOP_4	Stop the motor
RESET	Switch to normal operation mode

Accessories

See more accessories on www.ika.com.



Technical data

General data		
Voltage	VAC	220 ... 230 ± 10 % 115 ± 10 % 100 ± 10 %
Frequency	Hz	50 / 60
Power consumption (nominal)	W	92
Power consumption (standby)	W	3
Interface		USB
Noise level	dB(A)	< 55
Permissible ambient temperature	°C	+5 ... +40
Permissible relative humidity	%	80
IP code according to EN 60529		IP 20
Dimensions (W × D × H)	mm	200 × 280 × 140
Weight	kg	3.9
Operation at a terrestrial altitude	m	max. 2000
Centrifuging function		
Max. relative centrifugal force	g	16500
Max. kinetic energy	Nm	940
Max. load		12 X 2.0 ml safe lock tubes
Speed range	rpm	800 ... 15700
Speed deviation	%	± 2.5
Acceleration time to max. speed	s	17
Breaking time from max. speed	s	18
Speed display		LED
Speed setting		Buttons
Speed setting resolution	rpm	1 (x100)
Max. density	g/ml	1.2
Timer function		
Timer range		20 seconds ... 99 minutes 59 seconds
Timer display		LED
Timer setting		Buttons
Timer setting resolution		1 second

Subject to technical changes!

Warranty

In accordance with IKA warranty conditions, the warranty period is 24 months. For claims under the warranty please contact your local dealer. You may also send the machine direct to our factory, enclosing the delivery invoice and giving reasons for the claim. You will be liable for freight costs. The warranty does not cover worn out parts, nor does it apply to faults resulting from improper use, insufficient care or maintenance not carried out in accordance with the instructions in this operating manual.



designed for scientists

IKA-Werke GmbH & Co. KG

Janke & Kunkel-Straße 10, 79219 Staufen, Germany
Phone: +49 7633 831-0, Fax: +49 7633 831-98
eMail: sales@ika.de

USA

IKA Works, Inc.
Phone: +1 910 452-7059
eMail: usa@ika.net

KOREA

IKA Korea Ltd.
Phone: +82 2 2136 6800
eMail: sales-lab@ika.kr

BRAZIL

IKA Brazil
Phone: +55 19 3772 9600
eMail: sales@ika.net.br

MALAYSIA

IKA Works (Asia) Sdn Bhd
Phone: +60 3 6099-5666
eMail: sales.lab@ika.my

CHINA

IKA Works Guangzhou
Phone: +86 20 8222 6771
eMail: info@ika.cn

POLAND

IKA Poland Sp. z o.o.
Phone: +48 22 201 99 79
eMail: sales.poland@ika.com

JAPAN

IKA Japan K.K.
Phone: +81 6 6730 6781
eMail: info_japan@ika.ne.jp

INDIA

IKA India Private Limited
Phone: +91 80 26253 900
eMail: info@ika.in

UNITED KINGDOM

IKA England LTD.
Phone: +44 1865 986 162
eMail: sales.english@ika.com

Discover and order the fascinating products of IKA online:
www.ika.com



Technical specifications may be changed without prior notice.