

Register your instrument!
www.eppendorf.com/myeppendorf



Centrifuge 5430/5430 R

Original Operating Instructions

Copyright ©2022 Eppendorf SE, Hamburg. All rights reserved, including graphics and images. No part of this publication may be reproduced without the prior permission of the copyright owner.

Centriplus® is a registered trademark of Millipore Corporation, USA.

Microtainer® is a registered trademark of Becton Dickinson, USA.

Parasep® is a registered trademark of Apacor, UK.

CombiSlide® and QuickLock® are registered trademarks of Eppendorf SE, Germany.

Eppendorf VisioNize® is a registered trademark of Eppendorf SE, Germany.

Eppendorf® and the Eppendorf Brand Design are registered trademarks of Eppendorf SE, Germany.

Registered trademarks and protected trademarks are not marked in all cases with ® or ™ in this manual.

U.S. Design Patents are listed on www.eppendorf.com/ip.

Table of contents

1	Operating instructions	7
1.1	Using this manual	7
1.2	Danger symbols and danger levels	7
1.2.1	Danger symbols	7
1.2.2	Danger levels	7
1.3	Symbols used	8
1.4	Abbreviations used	8
2	Safety	9
2.1	Intended use	9
2.2	User profile	9
2.3	Information on product liability	9
2.4	Application limits	9
2.5	Warnings for intended use	10
2.5.1	Personal injury or damage to device	10
2.5.2	Incorrect handling of the centrifuge	12
2.5.3	Incorrect handling of the rotors	12
2.5.4	Extreme strain on the centrifugation tubes	13
2.5.5	Aerosol-tight centrifugation	14
2.6	Safety instructions on the device	15
3	Product description	17
3.1	Product overview	17
3.2	Features	18
3.3	Delivery package	19
3.4	Name plate	20
4	Installation	23
4.1	Selecting the location	23
4.2	Preparing installation	24
4.3	Installing the instrument	25
5	Operation	27
5.1	Operating controls	27
5.2	Menu navigation	29
5.3	Settings in the device menu	29
5.3.1	Programs	29
5.3.2	Use program keys	30
5.3.3	Other menu items	30
5.3.4	Settings	31
5.4	Configure centrifuge	32
5.4.1	Set menu language	32
5.4.2	Setting the date and time	33

5.5	Preparing for centrifugation	34
5.5.1	Switching on the centrifuge	34
5.5.2	Inserting the rotor	34
5.5.3	Automatic rotor detection	34
5.5.4	Manual rotor detection	34
5.5.5	Loading the rotor	35
5.5.6	Closing the centrifuge lid	38
5.6	Cooling (only 5430 R)	38
5.6.1	Temperature adjustment	38
5.6.2	Temperature display	38
5.6.3	Temperature monitoring	39
5.6.4	FastTemp	39
5.6.5	FastTemp pro	40
5.6.6	Continuous cooling	41
5.7	Centrifuging	41
5.7.1	Centrifugation with time setting	42
5.7.2	Centrifuging in continuous operation	42
5.7.3	Short-spin centrifugation	43
5.7.4	Removing the rotor	44
5.8	Standby mode	44
5.9	Information on the rotors	45
5.9.1	Rotor F-35-6-30: Plate carrier	45
5.9.2	Rotor A-2-MTP	46
5.9.3	Rotor FA-45-24-11-HS: Using the special rotor key	47
5.9.4	QuickLock	47
5.9.5	Rotor: S-24-11-AT: Use with centrifuge 5430	48
5.9.6	Rotor: S-24-11-AT: Use with centrifuge 5430 R	48
5.10	Information on aerosol-tight centrifugation	48
5.10.1	Aerosol-tight centrifugation in a fixed-angle rotor	49
6	Maintenance	51
6.1	Service options	51
6.2	Service	51
6.3	Prepare cleaning/disinfection	51
6.4	Cleaning/disinfection	52
6.4.1	Cleaning and disinfecting the device	53
6.4.2	Cleaning and disinfecting the rotor	54
6.5	Additional care instructions for refrigerated centrifuges	55
6.6	Cleaning glass breakage	55
6.7	Fuses	56
6.8	Decontamination before shipment	56
7	Troubleshooting	57
7.1	General errors	57
7.2	Error messages	58
7.3	Emergency release	60

8	Transport, storage and disposal	61
8.1	Transport	61
8.2	Storage	61
8.3	Disposal	62
9	Technical data	63
9.1	Power supply	63
9.2	Ambient conditions	64
9.3	Weight/dimensions	64
9.4	Noise level	65
9.5	Application parameters	65
9.6	Acceleration and deceleration times	66
9.7	Accessory service life	67
10	Rotors for the Centrifuge 5430 / 5430 R	69
10.1	Rotors	69
10.1.1	rcf display and calculation	73
11	Ordering Information	75
11.1	Rotors, rotor lids and gaskets	75
11.1.1	Rotors with QuickLock rotor lid	75
11.1.2	Rotors with threaded rotor lid	77
11.1.3	Rotor with attached rotor lids	79
11.2	Accessories	79
11.2.1	Adapter	79
11.2.2	Other accessories	80
11.2.3	Fuses for Centrifuge 5430	80
	Certificates	81

1 Operating instructions

1.1 Using this manual







- ▶ Read this operating manual completely before using the device for the first time. Observe the instructions for use of the accessories where applicable.
- ▶ This operating manual is part of the product. Please keep it in a place that is easily accessible.
- ▶ Enclose this operating manual when transferring the device to third parties.
- ▶ The current version of the operating manual for all available languages can be found on our webpage www.eppendorf.com/manuals.

The Centrifuge 5430 / 5430 R is available in two versions: **keypad** or **rotary knobs**. This operating manual generally describes how to operate the keypad version. However, it also applies to the rotary knob version.

1.2 Danger symbols and danger levels

1.2.1 Danger symbols

The safety instructions in this manual have the following danger symbols and danger levels:

	Biohazard		Electric shock
	Hazard point		Risk of crushing
	Explosive substances		Material damage

1.2.2 Danger levels

DANGER	<i>Will</i> lead to severe injuries or death.
WARNING	<i>May</i> lead to severe injuries or death.
CAUTION	May lead to light to moderate injuries.
NOTICE	May lead to material damage.

1.3 Symbols used

Depiction	Meaning
1. 2.	Actions in the specified order
▶	Actions without a specified order
•	List
<i>Text</i>	Display or software texts
i	Additional information

1.4 Abbreviations used

CE

European Community – A CE indicates that a product has been tested before being placed on the market and complies with the safety, health and/or environmental protection requirements of the European Union.

MTP

Microplate

PCR

Polymerase Chain Reaction

PTFE

Polytetrafluorethylene

rpm

Revolutions per minute

rcf

Relative centrifugal force : *g*-force in m/s^2

UV

Ultraviolet radiation

2 Safety

2.1 Intended use

The Centrifuge 5430 / 5430 R is used for the separation of aqueous solutions and suspensions of different densities in approved sample tubes.

The Centrifuge 5430 / 5430 R is exclusively intended for use indoors. All country-specific safety requirements for operating electrical equipment in the laboratory must be observed.

2.2 User profile

The device and accessories may only be operated by trained and skilled personnel.

Before using the device, read the operating manual and the instructions for use of the accessories carefully and familiarize yourself with the device's mode of operation.

2.3 Information on product liability

In the following cases, the designated protection of the device may be affected. The liability for any resulting damage or personal injury is then transferred to the owner:

- The device is not used in accordance with the operating manual.
- The device is used outside of its intended use.
- The device is used with accessories or consumables that are not recommended by Eppendorf.
- The device is maintained or repaired by persons not authorized by Eppendorf SE.
- The user makes unauthorized changes to the device.

2.4 Application limits



DANGER! Risk of explosion.

- ▶ Do not use the device in an explosive atmosphere.
 - ▶ Do not operate the device in areas where work with explosive substances is carried out.
 - ▶ Do not use this device to process any explosive or highly reactive substances.
 - ▶ Do not use this device to process any substances which could create an explosive atmosphere.
-

Due to its design and the environmental conditions inside the device, the Centrifuge 5430 / 5430 R is not suitable for use in a potentially explosive atmosphere.

The device must be used only in a safe environment, such as in the open environment of a ventilated laboratory or a fume hood. The use of substances which could create a potentially explosive atmosphere is not permitted. It is the user's responsibility to make the final decision on the risks associated with the use of such substances.

2.5 Warnings for intended use

2.5.1 Personal injury or damage to device



WARNING! Electric shock due to damage to the device or mains/power cord.

- ▶ Only switch on the device if the device and mains/power cord are undamaged.
- ▶ Only operate devices that have been properly installed or repaired.
- ▶ In case of danger, disconnect the device from the mains/power supply.



WARNING! Lethal voltages inside the device.

Touching parts under high voltage can cause an electric shock. Electric shocks cause injuries to the heart and respiratory paralysis.

- ▶ Ensure that the housing is closed and undamaged.
 - ▶ Do not remove the housing.
 - ▶ Make sure that no liquids can enter the device.
- Only authorized service staff may open the device.



WARNING! Danger due to incorrect voltage supply.

- ▶ Only connect the device to voltage sources which correspond with the electrical requirements on the name plate.
- ▶ Only use earth/grounded sockets with a protective earth (PE) conductor.
- ▶ Only use mains/power cords that are approved for the technical data specified on the name plate and taking into account national laws and regulations. This also includes testing labels if required by law.



WARNING! Damage to health due to infectious liquids and pathogenic germs.

- ▶ When handling infectious liquids and pathogenic germs, observe the national regulations, the biosafety level of your laboratory, and the manufacturers' Safety Data Sheets and application notes.
- ▶ Use aerosol-tight locking systems for the centrifugation of these substances.
- ▶ When working with pathogenic germs which belong to a higher risk group, more than one aerosol-tight bioseal must be used.
- ▶ Wear your personal protective equipment.
- ▶ Consult the "Laboratory Biosafety Manual" (source: World Health Organization, Laboratory Biosafety Manual, as amended) for comprehensive regulations on the handling of germs or biological material of risk group II or higher.



WARNING! Risk of injury from rotating rotor.

If the emergency release of the lid is operated, the rotor may continue to rotate for several minutes.

- ▶ Wait for the rotor to stop before activating the emergency release.
- ▶ To check, look through the monitoring glass in the centrifuge lid.



WARNING! Risk of injury when opening or closing the centrifuge lid.

There is a risk of crushing your fingers when opening or closing the centrifuge lid.

- ▶ Do not reach between the device and centrifuge lid when opening or closing the centrifuge lid.
- ▶ Do not reach into the locking mechanism of the centrifuge lid.
- ▶ Open the centrifuge lid fully to ensure that the centrifuge lid cannot slam shut.



WARNING! Risk of injury from chemically or mechanically damaged accessories.

Even minor scratches and cracks can lead to severe internal material damage.

- ▶ Protect all accessory parts from mechanical damage.
- ▶ Inspect the accessories for damage before each use. Replace any damaged accessories.
- ▶ Do not use rotors, rotor lids or buckets showing any signs of corrosion or mechanical damage (e.g. deformations).
- ▶ Do not use any accessories which have exceeded their maximum service life.
- ▶ When inserting the buckets and rotors, ensure that they do not become scratched.



CAUTION! Poor safety due to incorrect accessories and spare parts.

The use of accessories and spare parts other than those recommended by Eppendorf may impair the safety, functioning and precision of the device. Eppendorf cannot be held liable or accept any liability for damage resulting from the use of accessories and spare parts other than those recommended or from improper use.

- ▶ Only use accessories and original spare parts recommended by Eppendorf.



NOTICE! Damage to the device due to spilled liquids.

1. Switch off the device.
2. Disconnect the device from the mains/power supply.
3. Carefully clean the device and the accessories in accordance with the cleaning and disinfection instructions in the operating manual.
4. If a different cleaning and disinfecting method is to be used, contact Eppendorf SE to ensure that the intended method will not damage the device.



NOTICE! Damage to electronic components due to condensation.

Condensate may form in the device after it has been moved from a cool environment to a warmer environment.

- ▶ After installing the device, wait for at least 4 h. Only then connect the device to the mains/power line.

2.5.2 Incorrect handling of the centrifuge



NOTICE! Damage from knocking against or moving the device during operation.

If the rotor hits the rotor chamber wall, it will cause considerable damage to the device and rotor.

- ▶ Do not move or knock against the device during operation.
-

2.5.3 Incorrect handling of the rotors



WARNING! Risk of injury from improperly attached rotors and rotor lids.

- ▶ Only centrifuge with the rotor and rotor lid firmly tightened.
 - ▶ If any unusual noises occur when the centrifuge starts, the rotor or the rotor lid may not be attached properly. Stop the centrifugation immediately.
-



CAUTION! Risk of injury due to asymmetric loading of a rotor.

- ▶ Always load all positions of a swing-bucket rotor with buckets.
- ▶ Load buckets symmetrically with identical tubes or plates.
- ▶ Only load adapters with suitable tubes or plates.
- ▶ Always use tubes or plates of the same type (weight, material/density and volume).
- ▶ Use a balance to check that loading is symmetrical by balancing the adapters and tubes or plates that are used.

The device automatically detects imbalances during operation and stops the run immediately with an error message and a signal tone. Check the loading, balance the tubes and re-start the centrifugation.



CAUTION! Risk of injury from overloaded rotor.

The centrifuge is designed for the centrifugation of material with a maximum density of 1.2 g/mL at maximum speed and filling volume and/or load.

- ▶ Do not exceed the maximum load of the rotor.



CAUTION! Risk of injury due to chemically damaged rotor lids or caps.

Transparent rotor lids or caps made from PC, PP or PEI may lose their strength under the impact of organic solvents (e.g. phenol, chloroform).

- ▶ If rotor lids or caps have come into contact with any organic solvents, they should be cleaned immediately.
- ▶ Regularly check the rotor lids and caps for damage and cracks.
- ▶ Replace any rotor lids or caps showing any cracks or milky discolorations immediately.



NOTICE! Damage to rotors from aggressive chemicals.

Rotors are high-quality assemblies designed to withstand extreme stresses. This stability can be impaired by aggressive chemicals.

- ▶ Avoid using aggressive chemicals such as strong and weak alkalis, strong acids, solutions with mercury ions, copper ions and other heavy metal ions, halogenated hydrocarbons, concentrated saline solutions and phenol.
- ▶ If it is contaminated by aggressive chemicals, clean the rotor and especially the rotor bores immediately using a neutral cleaning agent.
- ▶ Due to the manufacturing process, color variations may occur on PTFE coated rotors. These color variations do not affect the service life or resistance to chemicals.



NOTICE! If handled incorrectly, the rotor may fall.

The swing-bucket rotor may fall if the buckets are used as handles.

- ▶ Remove the buckets before inserting and/or removing a swing-bucket rotor.
- ▶ Always use both hands to carry the rotor cross.

2.5.4 Extreme strain on the centrifugation tubes



CAUTION! Risk of injury from overloaded tubes.

- ▶ Note the loading limits specified by the tube manufacturer.
- ▶ Only use tubes which are approved by the manufacturer for the required g -forces (rcf).



NOTICE! Danger from damaged tubes.

Damaged tubes must not be used, as this could cause further damage to the device and the accessories and loss of the samples.

- ▶ Visually check all tubes for damage before use.



NOTICE! Danger due to deformed or brittle material. Autoclaving at excessively high temperatures can lead to plastic tubes, adapters and rotor lids becoming brittle and deformed.

This could result in damage to the device and the accessories and sample loss.

- ▶ Observe the temperatures specified by the manufacturer when autoclaving tubes.
- ▶ Do not use any deformed or brittle tubes.



NOTICE! Danger from open tube lids.

Open tube lids may break off during centrifugation and damage both the rotor and the centrifuge.

- ▶ Carefully seal all tube lids before centrifuging.

**NOTICE! Damage to plastic tubes due to organic solvents.**

The density of plastic tubes is reduced when organic solvents (e.g. phenol, chloroform) are used, i.e. the tubes may become damaged.

- ▶ Note the manufacturer's information on the chemical resistance of the tubes.

**NOTICE! Micro test tubes heat up.**

In non-refrigerated centrifuges, the temperature in the rotor chamber, rotor and sample may increase to above 40 °C, depending on the run time, *g*-force (rcf)/speed and ambient temperature.

- ▶ Please note that this will reduce the centrifugation stability of the micro test tubes.
- ▶ Please note the temperature resistance of the samples.

2.5.5 Aerosol-tight centrifugation

**WARNING! Damage to health due to limited aerosol tightness if an incorrect rotor/rotor lid combination is used.**

Aerosol-tight centrifugation is only guaranteed if the rotors and rotor lids intended for this purpose are used. The designation of aerosol-tight fixed-angle rotors always starts with **FA**. The aerosol-tight rotors and rotor lids of this centrifuge are also marked with a red ring on the rotor and a red rotor lid screw.







- ▶ Always use rotors and rotor lids marked as aerosol-tight together for aerosol-tight centrifugation. The details specifying in which centrifuge the aerosol-tight rotors and rotor lids may be used can be found on the rotor and on the top of the rotor lid.
- ▶ Only use aerosol-tight rotor lids in combination with the rotors indicated on the rotor lid.

**WARNING! Damage to health due to limited aerosol tightness if used incorrectly.**

Mechanical stresses and contamination by chemicals or other aggressive solvents may impair the aerosol tightness of the rotors and rotor lids. Autoclaving at excessively high temperatures can lead to plastic tubes, adapters and rotor lids becoming brittle and deformed.

- ▶ Check the integrity of the seals of the aerosol-tight rotor lids or caps before each use.
 - ▶ Only use aerosol-tight rotor lids or caps if the seals are undamaged and clean.
 - ▶ Do not exceed temperatures of 121 °C or a time of more than 20 min. when autoclaving.
 - ▶ After each proper autoclaving process (121 °C, 20 min.), coat the threads of the rotor lid screw with a thin layer of pivot grease (order no. Int. 5810 350.050, North America 022634330).
 - ▶ Replace aerosol-tight rotor lids without replaceable seals after 50 autoclaving cycles.
 - ▶ On aerosol-tight rotor lids with exchangeable seals (e.g. QuickLock rotor lids) the seal only needs to be replaced after 50 autoclaving cycles.
 - ▶ **Never** close aerosol-tight rotors or buckets for storage.
-

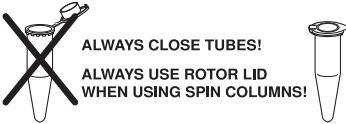
2.6 Safety instructions on the device

Symbol	Meaning	Location
	NOTICE ▶ Observe the safety instructions in the operating manual.	Rear of the device. Right side of the device.
	▶ Observe the operating manual.	
	• Warning of frostbite on cold surfaces	Left side of the device
	• Warning: Possible hand injury	Upper side of the device, under the centrifuge lid.
	▶ Always tighten the rotor with the enclosed rotor key.	Upper side of the device, under the centrifuge lid.
 <p>ALWAYS CLOSE TUBES! ALWAYS USE ROTOR LID WHEN USING SPIN COLUMNS!</p>	CAUTION ▶ Seal all tubes. ▶ Use the rotor lid.	Upper side of the device, under the centrifuge lid.
	Warning of biological risks when handling infectious liquids or pathogenic germs.	Aerosol-tight fixed-angle rotors: Rotor lid

3 Product description

3.1 Product overview

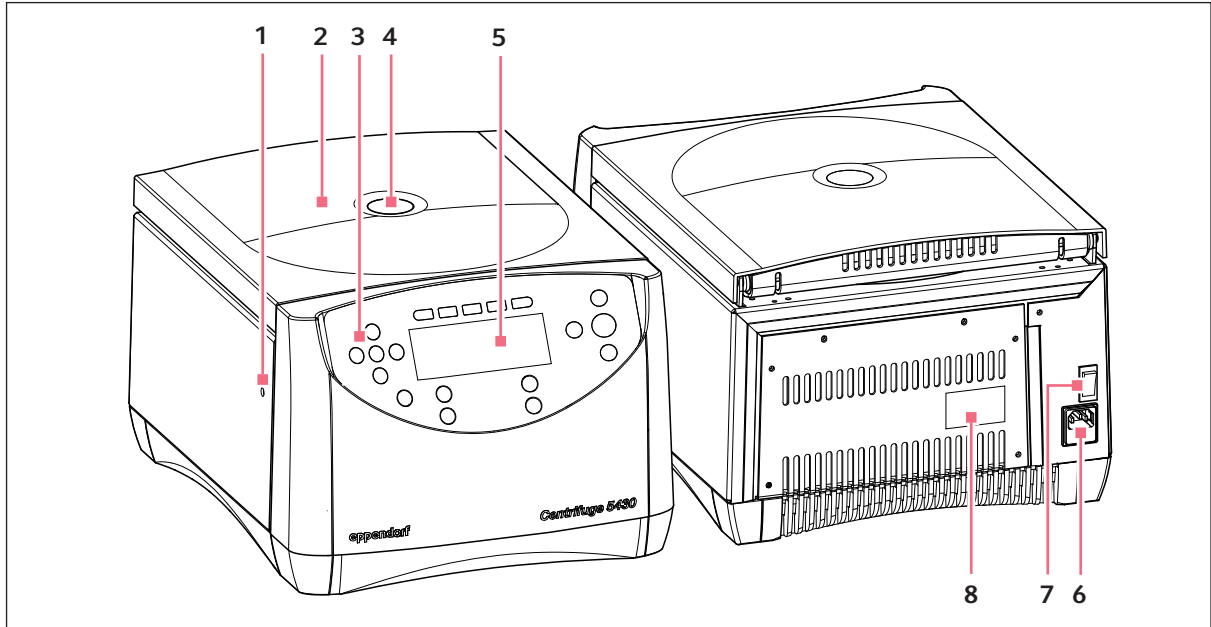

Fig. 3-1: Front and rear view of the Centrifuge 5430

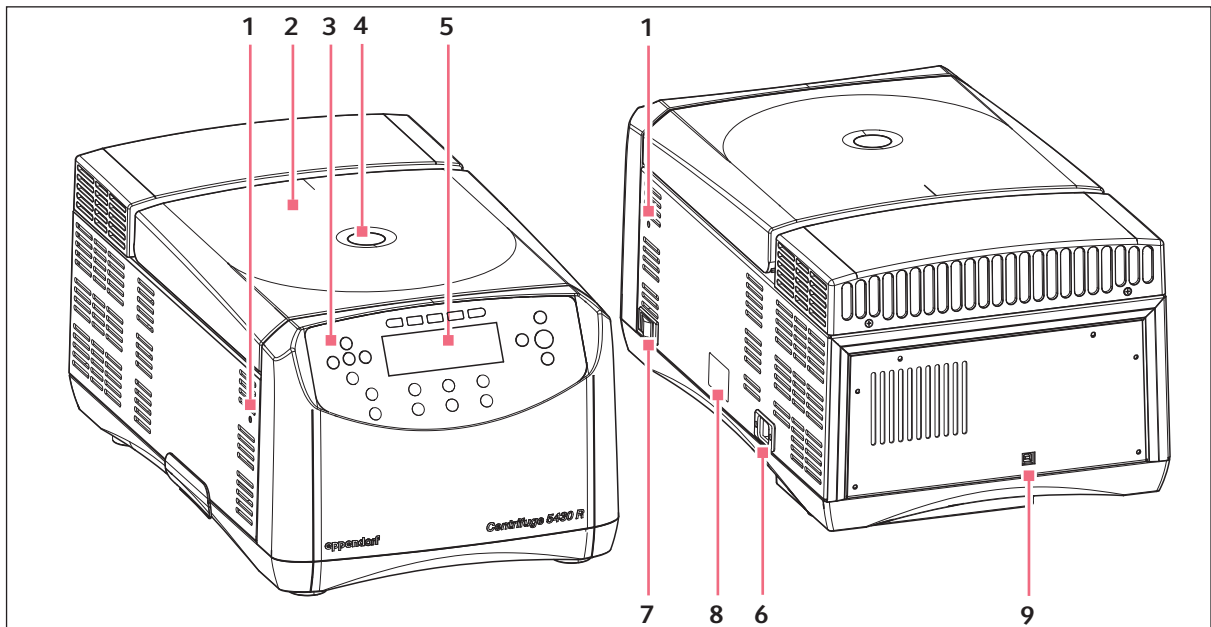

Fig. 3-2: Front and rear view of the Centrifuge 5430 R

Product description

Centrifuge 5430/5430 R
English (EN)

1 Emergency release

On both sides of the device (see *Emergency release* on p. 60).

2 Centrifuge lid**3 Control panel**

Keys and rotary knobs (dependent on the device version) for the operation of the centrifuge (see p. 27).

4 Monitoring glass

Visual monitoring for rotor stop or speed check option using stroboscope.

5 Display

Display of current centrifugation parameters and device settings (see p. 27).

6 Mains/power connection

Connection socket for the mains cable.

Only 5430: The fuse holder is located below it (see *Fuses* on p. 56).

7 Mains/power switch

Switch for switching the device on and off.

Switch position 0: The device is switched off.

Switch position I: The device is switched on.

8 Name plate**9 USB interface**

Interface for error analyses and software updates performed by the Technical Service.

3.2 Features

The multifaceted Centrifuge 5430 / 5430 R has a capacity of 48 x 2.0 mL and reaches max. 30,130 x g/ 17,500 rpm. The versatility is reflected in the available rotor options. You can select from 12 different rotors to centrifuge the following vessels for your various applications:

- Micro test tube (0.2 to 5.0 mL)
- PCR strips
- Microtainers
- Spin columns
- Cryogenic tubes
- Conical tubes (15/50 mL)
- Microplates
- PCR plates
- Deepwell plates (max. height 29 mm)
- Slides (with CombiSlide adapter)

Five program keys for rapid loading and saving of parameters as well as 45 further program slots, a large display and menu-controlled operation all make the centrifuge easy to use. The Centrifuge 5430 / 5430 R was designed based on latest ergonomic findings. This facilitates intuitive and easy operation.

The Centrifuge 5430 / 5430 R is available with two different control panels: One easy to clean keypad or blue rotary knobs to quickly set the centrifugation parameters.

The Centrifuge 5430 R has an additional temperature control function for centrifugation between -11°C and +40°C. The **Fast Temp** function is used to start a temperature control run without samples in order to quickly bring the rotor chamber, and rotor, bucket and adapter, to the set temperature. This temperature control cycle can also be started automatically at specified times using the **Fast Temp pro** function.

3.3 Delivery package

1	Centrifuge 5430 / 5430 R
1	Rotor key
1	Mains/power cord
1	Directions



- ▶ Check whether the delivery is complete.
- ▶ Check all parts for transport damage.
- ▶ Keep the transport box and packing material in order to transport and store the device safely.

3.4 Name plate

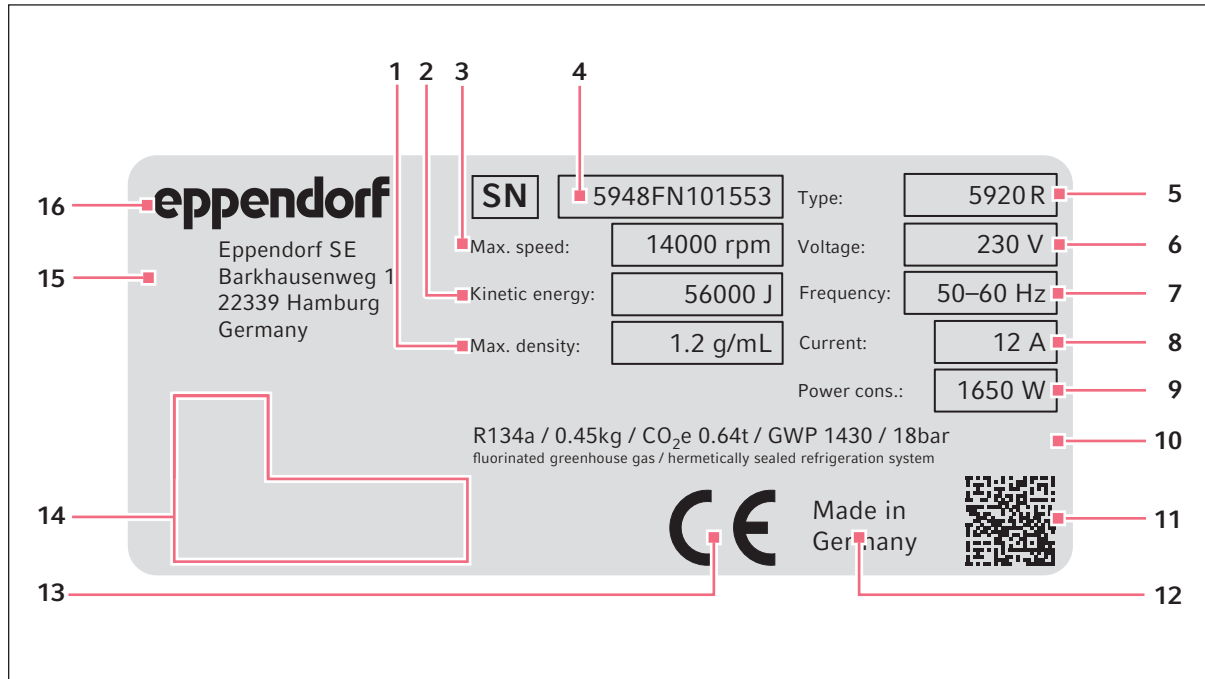







Fig. 3-3: Device identification of Eppendorf SE (example)

- | | |
|---|--|
| 1 Maximum density of the material for centrifuging | 9 Maximum rated power |
| 2 Maximum kinetic energy | 10 Information on the refrigerant (refrigerated centrifuges only) |
| 3 Maximum speed | 11 Data matrix code for serial number |
| 4 Serial number | 12 Designation of origin |
| 5 Product name | 13 CE marking |
| 6 Rated voltage | 14 Certification marks and symbols (device-specific) |
| 7 Rated frequency | 15 Manufacturer's address |
| 8 Maximum rated current | 16 Manufacturer |

Tab. 3-1: Certification marks and symbols (device-specific)

Symbol/ certification mark	Meaning
	Serial number
	Symbol for waste electrical and electronic equipment (WEEE) according to EU Directive 2012/19/EU, European Community
	UL listing certification mark: Declaration of conformity, USA
	Certification mark for electromagnetic compatibility of the <i>Federal Communications Commission</i> , USA
	Certification mark China – Use of certain hazardous substances in electrical and electronic products (<i>Requirements for Concentration Limits for Certain Hazardous Substances in Electronic Information Products SJ/T 11363-2006</i>), People's Republic of China

4 Installation

4.1 Selecting the location



WARNING! Danger due to incorrect voltage supply.

- ▶ Only connect the device to voltage sources which correspond with the electrical requirements on the name plate.
- ▶ Only use earth/grounded sockets with a protective earth (PE) conductor.
- ▶ Only use mains/power cords that are approved for the technical data specified on the name plate and taking into account national laws and regulations. This also includes testing labels if required by law.



NOTICE! If a fault occurs, any objects in the immediate proximity of the device will be damaged.

- ▶ In accordance with the recommendations of EN 61010-2-020, leave a safety clearance of **30 cm** around the device during operation.
- ▶ Please remove all materials and objects from this area.



NOTICE! Damage due to overheating.

- ▶ Do not install the device near heat sources (e.g., heating, drying cabinets).
- ▶ Do not expose the device to direct sunlight.
- ▶ Ensure unobstructed air circulation. Maintain a clearance of at least 30 cm around all ventilation gaps.



NOTICE! Radio interference.

For devices with Class A noise emission in accordance with [EN 61010-2-020](#) and [EN 61010-1](#), the following applies: This device has been developed and tested in accordance with CISPR 11 Class A. The device may cause radio interference in domestic environments and is not intended for use in residential areas. The device cannot ensure adequate protection of radio reception in residential areas and domestic environments.

- ▶ If necessary, take appropriate measure to eliminate the interferences.



Mains/power connection for centrifuges: Operation of the centrifuge is only permitted in building installations that comply with the applicable national regulations and standards. In particular, it must be ensured that there are no impermissible loads on the supply lines and assemblies that are located upstream of the internal protection of the device. This can be ensured by using additional circuit breakers or other suitable fuse elements in the building installation.



The mains/power switch and the disconnecting device for the mains/power line must be easily accessible during operation (e.g., a residual current circuit breaker).

Installation

Centrifuge 5430/5430 R
English (EN)

Select the location for the device according to the following criteria:

- Mains/power connection in accordance with the name plate
 - Minimum distance to other devices and walls: 30 cm
 - A resonance-free table with a horizontal, even work surface
 - The location has good ventilation.
 - The location is protected against direct sunlight.
- ▶ Do not use this device near strong electromagnetic sources (e.g., unshielded high frequency sources) as they could impair the proper operation of the device.

4.2 Preparing installation

Prerequisites

The weight of the centrifuge is 29 kg (5430) / 56 kg (5430 R). A second person is needed to unpack and position the device.



Retain the packaging material and the transport protection device for subsequent transport or storage. See also the instructions relating to transport (see p. 61).

- ▶ Perform the following steps in the sequence described.

Centrifuge 5430	Centrifuge 5430 R
<ol style="list-style-type: none"> 1. Open the packaging board. 2. Remove the covering cardboard. 3. Remove the accessories. 4. Grip from the strap retainers and have two persons lift the centrifuge out of the box. 5. Pull off the strap retainers, do not cut. 6. Remove the front and rear transport securing devices from the centrifuge. 7. Remove the plastic sleeve. 8. Carefully lift the centrifuge on one side and pull off the transport securing device of the motor on the underside of the centrifuge. 	<ol style="list-style-type: none"> 1. Open the packaging board. 2. Remove the accessories. 3. Lift and remove the front and rear transport securing devices. 4. Grip from the fabric straps and have two people lift the centrifuge out of the box. 5. Pull off the textile straps, do not cut. 6. Remove the plastic sleeve.

4.3 Installing the instrument

Prerequisites

The device is on a suitable lab bench.



NOTICE! Damage to electronic components due to condensation.

Condensate may form in the device after it has been moved from a cool environment to a warmer environment.

- ▶ After installing the device, wait for at least 4 h. Only then connect the device to the mains/power line.



NOTICE! Centrifuge 5430 R: Compressor damage after improper transport.

- ▶ After installation, wait 4 hours before switching on the centrifuge.

Perform the following steps in the sequence described:

1. Let the device warm up to ambient temperature for at least 3 hours (5430) or 4 hours (5430 R) to avoid damage electronic assemblies as a result of condensation and to avoid damage to the compressor (only 5430 R).
2. Check that the mains voltage and frequency match the requirements on the device type plate.
3. Connect the centrifuge to the mains/power line and switch it on at the mains/power switch.
 - The standby key  lights green.
 - The display is active.
 - **Only 5430:** Lid opens automatically.
4. **Only 5430:** Remove the transport securing device of the motor shaft.



5. If the delivery package includes a rotor, remove it using the supplied rotor key and take it out.
6. **Only 5430:** Remove the transport securing device of the air guide ring.

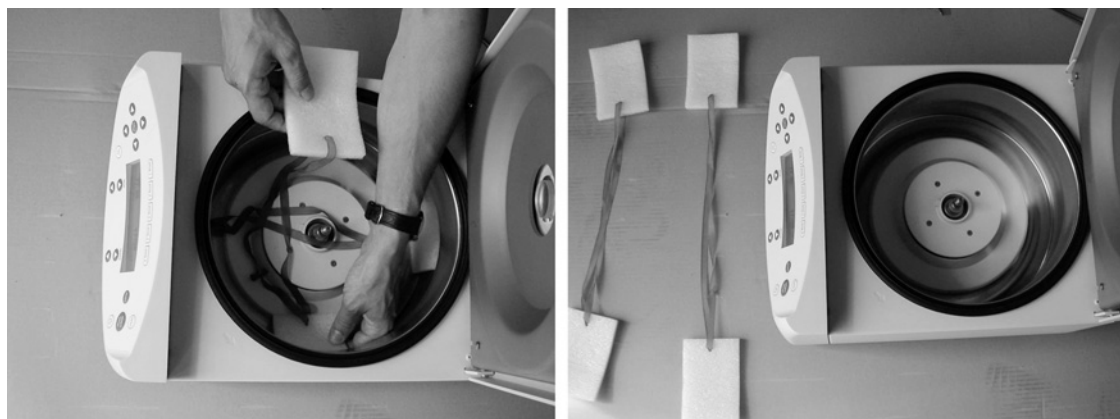

7. **5430 R only:** Insert the condensation water tray into the holder provided.

5 Operation

5.1 Operating controls

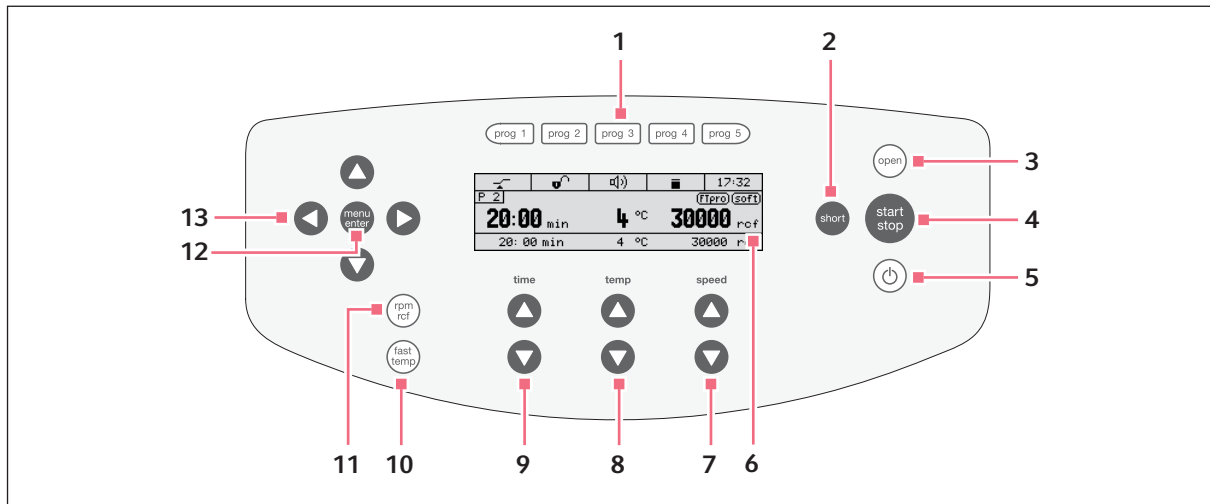

Fig. 5-1: Control panel and display of the Centrifuge 5430 / 5430 R (variant with keypad).

1 Selecting a program

Press briefly: Loading of the stored centrifugation parameters.

Press and hold down (> 2 s): Storing of the current centrifugation parameters (see p. 30).

2 Short run centrifugation

(see p. 43)

3 Lid release

4 Starting and stopping centrifugation

5 Activating/deactivating the standby mode

Key lights up green: centrifuge is ready for operation.

Key lights up red: standby mode is active.

6 Display

7 Setting the speed of centrifugation

Designed as key or rotary knob depending on the device variant.

8 Setting the temperature (5430 R only)

9 Setting the centrifugation time

Designed as key or rotary knob depending on the device variant.

10 Starting the Fast Temp temperature control run (5430 R only)

11 Switching the indicated speed of centrifugation (rpm/rcf)

12 Calling up and selecting the menu parameters (see p. 29)

13 Navigating in the menu (see p. 29)

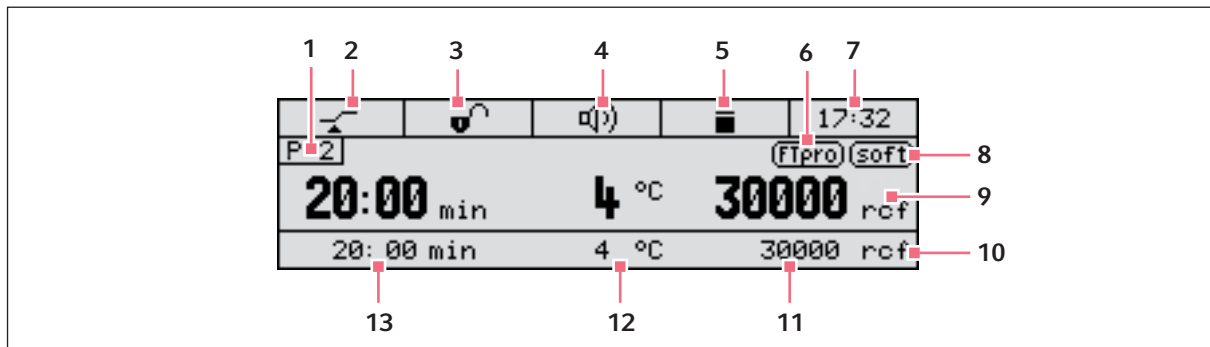

Fig. 5-2: Display of Centrifuge 5430 / 5430 R

1 Program number (if activated)**2 Status of the At set rpm function**

- ↗: Start of run time when reaching 95 % of the preset g-force (rcf) or speed (rpm).
- ↘: Immediate start of runtime.

3 Status of the key lock

- 🔒: Avoids unintended change of the centrifugation parameters.
- 🔓: Key lock not activated.

4 Status of the speaker

- 🔊: on.
- 🔇: off.

5 Status of the centrifuge

- 🔓: centrifuge lid unlocked.
- 🔒: centrifuge lid locked.
- 🔄 (Flashing): Centrifuging in progress.

6 Programming of the temperature control run (5430 R only)

- (FTpro): Fast Temp pro is activated, i.e. starting time and temperature of the temperature control run have been programmed .

7 Time**8 Soft ramp**







- (soft): Slow acceleration and braking of the rotor.
- No symbol: fast acceleration and braking of rotor.

9 Standard display**10 Expanded display (if activated)****11 g-force / rotational speed****12 Temperature (5430 R only)****13 Centrifugation time**

Please also read the detailed description of the individual functions (see p. 29).

5.2 Menu navigation

The menu consists of two levels. To change settings, generally proceed as follows.

1.		Open menu.
2.		Select the desired menu item.
3.		Confirm selection.
4.		Select the setting of the parameters in question.
5.		Confirm changed setting. A tick appears in front of the confirmed setting.
6.		Keep pressing the key until you reach the desired menu level or exit the menu. Some menus can only be exited by selecting and confirming the menu item <i>Back / Zurück / Retour / Atrás.</i>

5.3 Settings in the device menu

5.3.1 Programs

The Centrifuge 5430 / 5430 R has more than 50 programmable memory locations.

Load program	Load the selected program. This appears in the display with number and name and can be started immediately using the \diamond start/stop key. When selecting a program with a too high g-force (rcf)/speed for the rotor used, it flashes and a safety message appears.
Save program	Save the set centrifugation parameters (centrifugation duration, temperature (only 5430 R), g-force (rcf)/speed, soft ramp and At set rpm) under the selected number. In addition, you can assign a program name with a maximum of 20 characters. The centrifuging duration, the temperature (only 5430 R) and the g-force/rotational speed can still be changed in this menu using the corresponding arrow buttons time , temp (only 5430 R) and speed .
Delete program	Delete the selected program. Program numbers 1 to 5 cannot be deleted.

These functions are only available with the centrifuge at a standstill.

If the program memory is empty the menu item *Delete program* is exited automatically after the last program has been deleted. You will furthermore be unable to call up this menu item if the program memory is empty.

Program numbers which are already occupied can be overwritten.

5.3.2 Use program keys

You can also save and load Programs 1 to 5 directly by pressing the program keys:

5.3.2.1 Load program

- ▶ Press the desired program key **briefly**.

The pressed program key illuminates in blue, the parameters are displayed.

By pressing again, you can exit the selected program again. The blue light of the key will then go out. The parameters of the most recent centrifugation are then displayed again.





5.3.2.2 Save program

1. Set the centrifugation parameters (centrifugation duration, temperature (only 5430 R), g-force (rcf)/speed, soft ramp and At set rpm).
2. Press the desired program key for at least **2 seconds**.

A signal tone sounds and the program key you pressed lights up.







The centrifuging parameters are saved under the appropriate program number (1-5).

5.3.3 Other menu items

Menu item/meaning	Setting	Function	Display
Soft ramp Reduce speed of acceleration and braking ramp. Not used for Short Spin centrifuging.	on off	Rotor accelerates and brakes slowly. Rotor accelerates and brakes rapidly.	
Key lock Set the current centrifugation parameters permanently to prevent the time, temperature (only 5430 R), g-force (rcf) or speed, soft ramp and At set rpm from being unintentionally modified.	on off	Set the centrifugation parameters permanently. Release the permanent settings.	 
At set rpm Set start of centrifuging run time.	on off	The set time is counted down only once 95% of the specified g-force (rcf) or speed has been reached. The set time is counted down immediately.	 
Short Spin Before the start of a short run (see <i>Short-spin centrifugation on p. 43</i>) it is possible to switch between the maximum and currently set g-force (rcf) or speed. Soft ramp is not used for Short Spin centrifuging.	Maximum value Current value	Short-spin run at maximum g-force (rcf) or speed of the rotor used. Short run at set g-force (rcf)/speed.	

Menu item/meaning	Setting	Function	Display
Continuous cooling (only 5430 R) Time limitation of continuous cooling (see p. 41) . Continuous cooling is only activated when the rotor is stopped and the centrifuge lid is closed.	8 h ∞	Preset value. Endless operation of continuous cooling. Caution! Icing possible! Set at own risk!	
Fast Temp pro (only 5430 R) Time and temperature programming for the automatic temperature control run. The selection <i>Once/Repeatedly</i> only appears if no Fast Temp pro has been set (see <i>FastTemp pro</i> on p. 40).	Once Repeatedly	Set the date and time for the start of a temperature control run. Set the week days and the common start time for several repeated temperature control runs. Fast Temp pro is active from the date set.	FTpro

5.3.4 Settings

Menu item/meaning	Setting	Function	Display
Display Select standard display or extended display of centrifuging parameters.	Standard display Extended display	If the centrifuge is at rest the target values are displayed, and during centrifugation the actual values of run time, temperature (only 5430 R) and the g-force (rcf)/speed. In addition to the standard display, specified values are always shown at the bottom of the display.	
Loudspeaker Switch loudspeaker on and off. In the event of error messages, a signal tone sounds even if the loudspeaker is switched off.	On Off	Switch on loudspeaker. Switch off loudspeaker.	 
Volume Adjust the speaker volume using the menu arrow keys  and  in 5 stages. The signal tone for error messages is always issued at least at medium volume.	Cancel Save Default	Exit menu item without saving. Save volume just set. Restore default volume.	
Date/time Set date and time. The system does not switch automatically between summer and winter time.		In the date display, set year (YYYY), month (MM) and day (DD). In the time display, set hours (hh) and minutes (mm). Before setting the clock time the time format is selected (12 h / 24 h).	
Contrast Adjust the display contrast using the menu arrow keys  and  .	Cancel Save Default	Exit menu item without saving. Save the contrast just set. Restore default contrast.	

Operation









Centrifuge 5430/5430 R
English (EN)

Menu item/meaning	Setting	Function	Display
Language		Set menu language (English, Deutsch, Français or Español) . (see <i>Set menu language on p. 32</i>).	
Standby Switch standby mode on and off. If the centrifuge is not used during the set time period and no continuous cooling takes place (only 5430 R), it switches to the standby mode (see p. 44).	On Off Set time	Switch on standby mode. Switch off standby mode. Using the arrow keys, set the time after which the centrifuge should automatically change to the standby mode (1 to 60 min).	
Lid release (only 5430)	Automatic Manual	Lid opens automatically at the end of centrifuging when the rotor stops. Lid remains closed at the end of centrifuging when the rotor stops and can be opened using the now flashing key open .	

5.4 Configure centrifuge

5.4.1 Set menu language

Proceed as follows to set menu language.

1.		Open the menu.
2.		Select <i>Settings</i> .
3.		Confirm your selection.
4.		Select <i>Language</i> .
5.		Confirm your selection.
6.		Select <i>English, Deutsch, Français</i> or <i>Espanol</i> .
7.		Confirm your selection. A tick appears in front of the selected language. The setting takes effect immediately.
8.		Press key several times to exit the menu.

5.4.2 Setting the date and time

Proceed as follows to set date and time.

1.		Open the menu.
2.		Select <i>Settings</i> .
3.		Confirm your selection.
4.		Select <i>Date/time</i> .
5.		Confirm your selection.
6.		Set date.
7.		Confirm setting.
8.		Set time format (12 h/24 h).
9.		Confirm setting.
10.		Set time.
11.		Confirm setting.
12.		Press key several times to exit the menu.



There is no automatic switch between summer time and winter time.

5.5 Preparing for centrifugation

5.5.1 Switching on the centrifuge

1. Switch on the centrifuge using the mains power switch or the  standby key.
Only 5430: After switching the device on at the mains/power switch, the centrifuge lid opens automatically.
2. Open the closed centrifuge lid by pressing the **open** key.
The parameter settings of the last run are displayed.

5.5.2 Inserting the rotor



- ▶ **Swing-bucket rotors:** Remove the buckets before inserting and/or removing the rotor. Use both hands to pick up the rotor cross.
- ▶ **Rotor F-35-6-30:** Only insert and/or remove the rotor with the enclosed rotor removal tool.

1. Place the rotor vertically onto the motor shaft.
2. Insert the supplied rotor key into the rotor nut.
Rotor FA-45-24-11-HS: use the special rotor key.
3. Turn the rotor key **clockwise** until the rotor nut is firmly tightened.

5.5.3 Automatic rotor detection

The centrifuge has automatic rotor detection. It detects a newly inserted rotor during centrifugation and displays its name for approx. 2 seconds. The set g-force (rcf)/speed (rpm) is automatically limited to the maximum permissible value of the rotor, if necessary.



If you start centrifuging immediately after a rotor change, the centrifuge has not carried out an automatic rotor detection yet. The speed set for the previous rotor may exceed the maximum permitted speed for the new rotor. In this case, the centrifuge stops after the automatic rotor detection and displays the error message *Note C*. The new maximum permissible speed is displayed. You can now restart centrifugation with this setting or adjust the speed.

- ▶ Always check the set g-force (rcf)/speed (rpm) after a rotor change and adjust it if necessary.

5.5.4 Manual rotor detection



CAUTION! Risk of injury when turning the rotor manually.

- ▶ When turning a swing-bucket rotor, ensure that your fingers do not get jammed or caught on the buckets.

- ▶ In order to trigger the rotor detection manually, turn the rotor **counterclockwise** by hand.
 - The name of the rotor appears in the display.
 - The g-force (rcf)/speed (rpm) automatically is limited to the maximum value of the rotor.

5.5.5 Loading the rotor



CAUTION! Risk of injury due to asymmetric loading of a rotor.

- ▶ Always load all positions of a swing-bucket rotor with buckets.
- ▶ Load buckets symmetrically with identical tubes or plates.
- ▶ Only load adapters with suitable tubes or plates.
- ▶ Always use tubes or plates of the same type (weight, material/density and volume).
- ▶ Use a balance to check that loading is symmetrical by balancing the adapters and tubes or plates that are used.

The device automatically detects imbalances during operation and stops the run immediately with an error message and a signal tone. Check the loading, balance the tubes and re-start the centrifugation.



CAUTION! Danger from damaged or overloaded tubes.

- ▶ When loading the rotor, observe the safety instructions for hazards resulting from overloaded or damaged tubes.



The device automatically detects imbalances during operation and stops the run immediately with an error message and a signal tone.

- ▶ Check the load, balance the tubes and restart the run.

5.5.5.1 Fixed-angle rotors



Rotor lid

- Fixed-angle rotors may only be operated with the appropriate rotor lid in each case. This is clearly shown by the identical rotor name labeling on the rotor and on the rotor lid.
- To carry out an aerosol-tight centrifugation, an aerosol-tight rotor (label: **red ring**) and the corresponding aerosol-tight rotor lid (label: **aerosol-tight** and **red lid screw**) must be used.

To load the rotor, proceed as follows:

1. Check the maximum load (adapter, tube and contents) per rotor bore.
The information about this can be found on the rotor and in this operating manual (see *Rotors on p. 69*).
2. Load rotors and adapters only with the tubes intended for them.
3. Insert tubes opposite each other in pairs into the rotor bores. To ensure symmetrical loading, tubes that are arranged opposite each other must be of the same type and contain the same filling quantity.

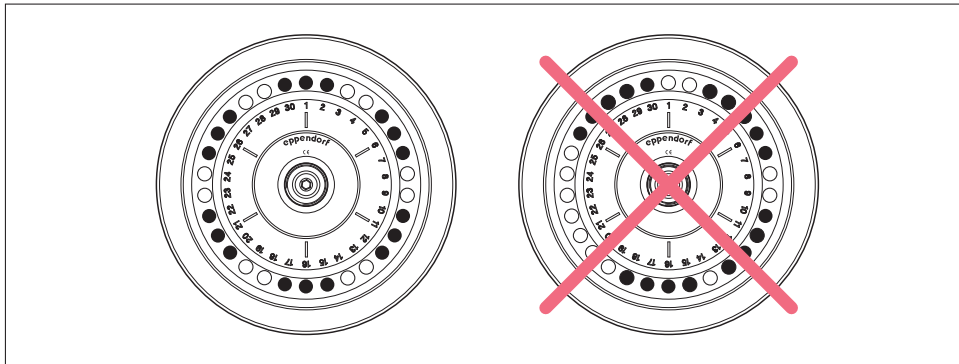

To keep the weight differences between the filled sample tubes low, we recommend taring with a balance. This will reduce wear on the drive and cut operating noise.

4. Attach and tighten the rotor lid.



Spin columns

For centrifuging spin columns in the rotor FA-45-24-11-Kit, you can leave the tube lids open. However, this is only permitted with the tubes specified by the kit manufacturers. For reliable centrifugation, you must lean the open tube lids against the edge of the rotor. Ensure that this does not involve the lids projecting beyond the edge of the rotor, and then put on the associated rotor lid.

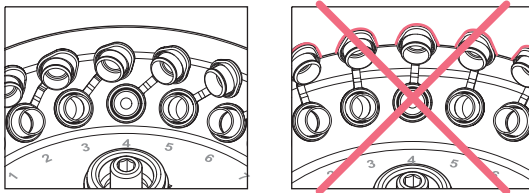

5.5.5.2 Swing-bucket rotors

Prerequisites

- A rotor, bucket and adapter combination approved by Eppendorf.
- Opposite buckets have the same weight category.
- Matching and tested tubes and plates.



NOTICE! Filling the plates too high can cause overflowing.

During the run the meniscuses in the tubes along the edges of the plates are at an angle. This is due to the centrifugal forces and cannot be avoided.

- ▶ Fill the plate wells to a maximum of 2/3 of the maximum filling volume.

To load the rotor, proceed as follows:

1. Make sure that the bucket grooves are clean and lightly grease them with pivot grease (int. order no.: 5810 350.050/North America: 022634330).
Dirty grooves and pivots prevent the buckets from swinging out evenly.
2. Hang the buckets into the rotor.
All rotor positions must be equipped with buckets.
3. Check to see if all buckets are completely hung and can freely swing out.
4. Carry out a manual loading and swing test the first time a tube or plate type is used.
5. Check and observe the maximum load per bucket (adapter, tube or plate and contents) and the loading height.
The information about this can be found on the rotor and in this operating manual (see *Rotors on p. 69*).
6. Load the buckets symmetrically.

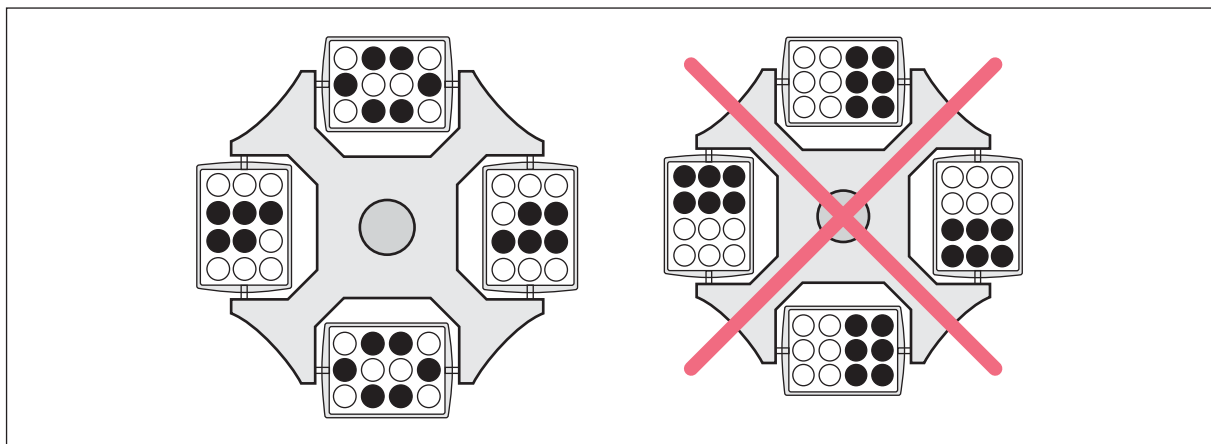

Fig. 5-3: Incomplete, but symmetrical loading of the buckets. All pivots of the rotor have to be evenly loaded.

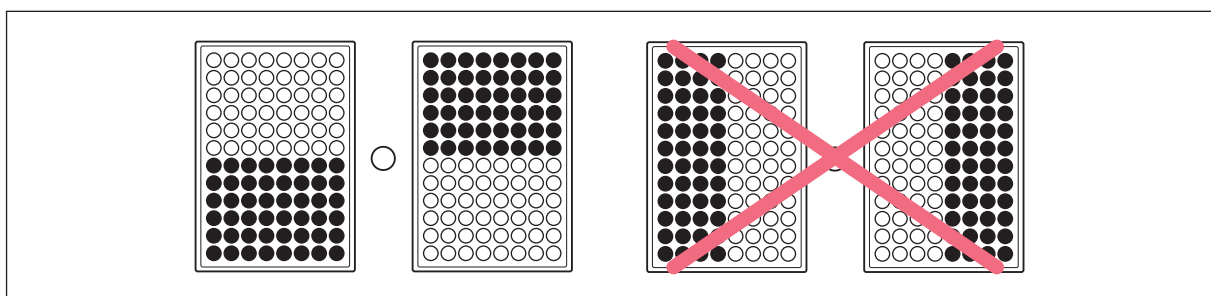

Fig. 5-4: Symmetrical loading of the plates.

The plate charging shown on the right-hand side is incorrect as the buckets will not swing out properly. The plates have some play in the buckets.

7. Check the loading of the buckets.

Operation

Centrifuge 5430/5430 R
English (EN)



- ▶ Carry out a brief centrifugation test at low speed (e.g., 1000 rpm) when you use a tube or plate type for the first time.



5430 R only: When using the A-2-MTPs, centrifuge without the upper shell of the wind shield in order to guarantee precise and quick temperature control of samples. Note that the centrifugation noise will increase slightly in this case.
This does not apply to the S-24-11-AT. The S-24-11-AT must always be operated with a rotor lid.

5.5.6 Closing the centrifuge lid



WARNING! Risk of injury when opening or closing the centrifuge lid.

There is a risk of crushing your fingers when opening or closing the centrifuge lid.

- ▶ Do not reach between the device and centrifuge lid when opening or closing the centrifuge lid.
- ▶ Do not reach into the locking mechanism of the centrifuge lid.
- ▶ Open the centrifuge lid fully to ensure that the centrifuge lid cannot slam shut.

1. Check the correct attachment of the rotor and rotor lid.
2. Push down the centrifuge lid until the lid latch engages and the lid is automatically closed.
The centrifuge will close automatically.
The **open** key lights up blue. ■ appears on the display.

5.6 Cooling (only 5430 R)

5.6.1 Temperature adjustment

- ▶ Set the temperature using the **temp** arrow keys between -11°C and +40°C.
The temperature can also be changed during centrifugation.
At higher ambient temperature a brief fan noise is possible until the desired temperature has been reached. This indicates a heavy cooling performance.

5.6.2 Temperature display

If the rotor is stopped:	Set temperature
During centrifugation:	Actual temperature

The set temperature appears in the extended display.

5.6.3 Temperature monitoring

After the set temperature has been reached, the centrifuge reacts to temperature deviations during centrifugation as follows:

Deviation from set value	Action
± 3 °C	Temperatures on the display are flashing.
± 5 °C	Periodic warning tone and display <i>Error 18</i> . Centrifugation is stopped automatically.

5.6.4 FastTemp

This function can be used to start a temperature control run directly without samples with a rotor and temperature-specific speed in order to quickly adjust the rotor chamber, including the rotor, buckets and adapters, to the previously set temperature.

The **FastTemp pro** function for programming the temperature control run with defined start times is described in the next section.

Prerequisites

- The centrifuge is switched on.
- The rotor and rotor lid are attached properly.
- The centrifuge lid is closed.
- Temperature and g-force (rcf)/speed (rpm) for the centrifugation are set (see *Centrifuging on p. 41*).

1. Press the **fast temp** key.

The display shows *Fast Temp*, the remaining duration of the temperature control run as well as the current temperature and g-force (rcf)/speed (rpm).

The temperature control run ends automatically when the set temperature is reached. A periodic signal tone sounds.

2. Press the **start/stop** key to end the temperature control run early.

After the set temperature has been reached and the temperature control run is complete, the centrifuge keeps the rotor chamber with the centrifuge lid closed at the set target temperature if the temperature is below the ambient temperature. However, independent of the target temperature, 4 °C must be met via this continuous cooling in order to prevent the rotor chamber from freezing.



The centrifuge stops the cycle automatically if the rotor or the buckets have reached the set temperature. Therefore, there may be a delay of approx. 30 min between the display of the set temperature and the automatic end of the temperature control run.



5430 R only: When using the A-2-MTPs, centrifuge without the upper shell of the wind shield in order to guarantee precise and quick temperature control of samples. Note that the centrifugation noise will increase slightly in this case.

This does not apply to the S-24-11-AT. The S-24-11-AT must always be operated with a rotor lid.

5.6.5 FastTemp pro

You can have the previously described temperature control run **FastTemp** (see p. 39) start automatically at a specified time. Two options are available:

Once	The temperature control run is started once at the set time.
Several times	The temperature control run is started at the set time on the next specified weekday. This is repeated for an unlimited period of time with each weekday specified.

5.6.5.1 Programming the start time

1. Select *Fast Temp pro* in the device menu.
2. Select *Once* or *Repeatedly*.
This selection only appears as long as the **FastTemp pro** function has not already been activated. Otherwise it is only possible to edit or delete the programmed start time.
3. Only if *Several times* is selected: Activate/deactivate weekdays with **menu/enter**, select *Next* and confirm with **menu/enter**.
4. Enter date and time for the one-time or repeated start of the temperature control run as well as the set temperature and confirm with **menu/enter**.
An overview of the current settings is displayed.
5. Edit the settings again or save.
6. Exit the menu.
 - **FastTemp pro** is now activated. In the display the **FTPRO** symbol appears as long as an automatic start of a temperature control run is still outstanding. In the standby mode **FTPRO** *Fast Temp pro* is displayed.
 - The temperature control run **FastTemp** (see p. 39) starts automatically at the set time.
 - After a one-off programmed temperature control run, the following symbol is extinguished **FTPRO**. With several programmed temperature control runs, the **FastTemp pro** remains active until you deactivate it. To do this, select *Fast Temp pro* in the device menu and delete the settings.

5.6.5.2 Preparing the centrifuge

- ▶ Ensure that the centrifuge is switched on or in the standby mode during the start time set and the rotor and rotor lid are properly attached and the centrifuge lid is closed.

5.6.5.3 Automatic start of the temperature control run

1. If the centrifuge is in standby mode, it switches to the operating mode 1 min before the set start time.
2. At the start time the temperature control run **FastTemp** (see *FastTemp* on p. 39) begins. *Fast Temp pro* appears in the display.

Automatically starting the temperature control run is not possible during centrifugation.

5.6.6 Continuous cooling

If the rotor stops, the rotor chamber will be maintained at the target temperature if the following requirements have been met:

- The centrifuge is switched on.
- The centrifuge lid is closed.
- The set temperature is lower than the ambient temperature.
- The centrifuge is not in standby mode.

During continuous cooling the following applies:

- The set and actual temperature are displayed alternately.
- Irrespective of the set temperature, the temperature does not go below 4 °C to prevent the rotor chamber from freezing and from increased condensation in the device.
- The temperature adjustment takes longer because the rotor is not rotating.

To end continuous cooling, open the centrifuge lid or press the standby key.

If the centrifuge is not used for more than 8 hours, the continuous cooling is switched off automatically. The device then switches to standby mode. This protects against ice formation in the rotor chamber and increased condensation in the device. With **FastTemp** you can quickly reach the desired temperature again (see p. 39).

You can change the continuous cooling to endless operation at your own risk. To do so, in the device menu under *Continuous cooling* enable the ∞ (see p. 30) item.

5.7 Centrifuging



CAUTION! Danger due to incorrectly loaded rotors and damaged/overloaded tubes!

- ▶ Before commencing centrifugation, follow the safety instructions relating to risks from asymmetrically loaded and/or overloaded rotors and from overloaded, damaged and/or open tubes.



WARNING! Risk of injury from improperly attached rotors and rotor lids.

- ▶ Only centrifuge with the rotor and rotor lid firmly tightened.
 - ▶ If any unusual noises occur when the centrifuge starts, the rotor or the rotor lid may not be attached properly. Stop the centrifugation immediately.
-

Each of the centrifuging variants described here must be preceded by the preparation described above (see *Preparing for centrifugation* on p. 34).



5430 R only: Please also note the instructions on cooling (see *Cooling (only 5430 R)* on p. 38).

5.7.1 Centrifugation with time setting

Perform the following steps in the sequence described.

1. Use the **time** arrow keys to set run time.
2. **5430 R only:** Use the **temp** arrow keys to adjust the temperature.
3. Use the **speed** arrow keys to the g-force (rcf)/speed.
4. Press **start/stop** to start centrifuging.

During centrifugation:

-  blinks in the display as long as the rotor is running.
- The remaining run time will be displayed in minutes. The last minute is counted down in seconds.
- **5430 R only:** The current temperature will be displayed.
- The current g-force (rcf) or rotor speed is displayed.
- The shortcut keys, the , **open** and **short** keys, and all menu items which directly affect centrifugation, are blocked during centrifugation.

End of centrifugation

- The centrifuge automatically stops after the set time has elapsed. The elapsed centrifugation will be shown in a blinking display during the braking process. A signal tone sounds when the rotor is at a standstill.
 - **Only 5430:** The centrifuge lid opens automatically. The display shows the symbol .
 - **5430 R only:** The centrifuge lid remains closed to maintain the sample temperature. It can be opened lid by pressing the blinking **open** key.
5. Remove the material for centrifuging.



- During the run you can modify the total run time, the temperature (only 5430 R), the speed and the rpm/rcf indication. The new parameters are adopted immediately. Please note that the shortest new total run time that can be set is the elapsed time plus 2 minutes.
- You can also terminate the centrifugation before the set run time has elapsed by pressing the **start/stop** key.

5.7.2 Centrifuging in continuous operation



Perform the following steps in the sequence described.

1. Use the **time** arrow keys to set the continuous run.
The continuous operation function can be set above 99:59 h or below 30 seconds. The timer shows ∞ to indicate continuous operation.
2. **5430 R only:** Use the **temp** arrow keys to adjust the temperature.
3. Use the **speed** arrow keys to the g-force (rcf)/speed.
4. Press **start/stop** to start centrifuging.
 blinks in the display as long as the rotor is running.
Time is counted upwards, first in 30-second increments and then in minute increments from ten minutes.

5. Press **start/stop** to end centrifuging after the desired time period.
 - The centrifugation time will be shown in a blinking display during the braking process.
 - A signal tone sounds when the rotor is at a standstill.
 - **Only 5430:** The centrifuge lid opens automatically. The display shows the symbol .
 - **5430 R only:** The centrifuge lid remains closed to maintain the sample temperature. It can be opened lid by pressing the blinking **open** key.
6. Remove the material for centrifuging.

5.7.3 Short-spin centrifugation

You can carry out a short-spin cycle with the currently set or with the maximum g-force (rcf)/speed of the rotor used. This is set in the device menu (see *Other menu items on p. 30*) before executing the following steps in the sequence specified:

1. For short-spin cycle with the current g-force (rcf)/speed, set this directly with the arrow keys **speed**.
2. **5430 R only:** Use the **temp** arrow keys to adjust the temperature.
3. Start the short run: Hold the **short** key pressed down.
 -  blinks in the display as long as the rotor is running.
 - The time is counted upwards in seconds.
 - During short run centrifuging all other keys are blocked. However, short run centrifuging is interrupted if another key is pressed simultaneously.
4. End short spin run: Release the **short** key.
 - The centrifugation time will be shown in a blinking display during the braking process.
 - A signal tone sounds when the rotor is at a standstill.
 - **Only 5430:** The centrifuge lid opens automatically. The display shows the symbol .
 - **5430 R only:** The centrifuge lid remains closed to maintain the sample temperature. It can be opened lid by pressing the blinking **open** key.
5. Remove the material for centrifuging.



During the braking process, you can restart the centrifugation up to two times by pressing the **short** key again.



The soft ramp does not work during short-spin centrifugation.

Operation

Centrifuge 5430/5430 R
English (EN)

5.7.4 Removing the rotor

- ▶ **Swing-bucket rotors:** Remove the buckets before inserting and/or removing the rotor. Use both hands to pick up the rotor cross.
- ▶ **Rotor F-35-6-30:** Only insert and/or remove the rotor with the enclosed rotor removal tool.

1. Turn the rotor nut **counterclockwise** using the supplied rotor key.
Rotor FA-45-24-11-HS: use special rotor key.
2. Remove the rotor vertically in an upward motion.
3. **5430 R only:** Switch off the centrifuge after use and empty the condensation water tray (remove it from the left side of the device). Leave centrifuge lid fully opened and protect it against closing.

5.8 Standby mode

The centrifuge automatically changes from the ready state to the standby mode if the following prerequisites are met:

- The centrifuge was not used for the time set in the device menu (1 to 60 min)(see *Settings on p. 31*)
- **5430 R only:** The centrifuge lid is open.

In the **Standby mode**, the following applies :

- The standby key  lights red.
- **5430 R only:** The rotor chamber is not cooled (see *Continuous cooling on p. 41*).

In the **Ready state**, the following applies:

- The centrifugation parameters are displayed.
- The standby key  lights green.
- **5430 R only:** The rotor chamber is cooled when the centrifuge lid is closed (see *Continuous cooling on p. 41*).

You can switch between standby mode and ready state at any time when centrifugation is not performed by pressing the standby key.

5.9 Information on the rotors

5.9.1 Rotor F-35-6-30: Plate carrier

5.9.1.1 Transferring the rotor

Prerequisites

The rotor nut is loose.

Use the plate carrier to insert the rotor in the centrifuge and to remove it.

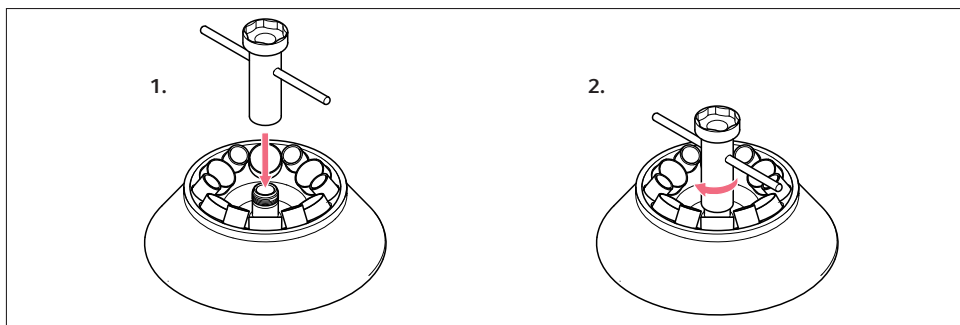

1. Fit the plate carrier with the narrow side on the rotor thread.
2. Tighten the plate carrier by approx. 3 turns in clockwise direction.
3. Hold onto the plate carrier and transfer the rotor.
4. Remove the plate carrier by turning it counterclockwise.
5. **Inserting the rotor:** Tighten the rotor with the enclosed rotor key (see *Inserting the rotor on p. 34*).

5.9.1.2 Loosening the rotor lid

Use the plate carrier to loosen firmly tightened rotor lid screws.

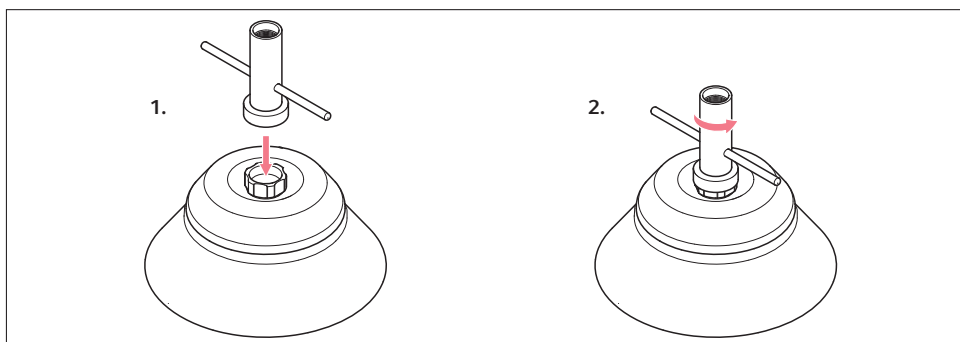

1. Position the plate carrier with the wide side on the rotor lid screw.
2. Loosen the rotor lid screw by turning the plate carrier counterclockwise.

5.9.2 Rotor A-2-MTP

5.9.2.1 Transferring the rotor



NOTICE! If handled incorrectly, the rotor may fall.

The swing-bucket rotor may fall if the buckets are used as handles.

- ▶ Remove the buckets before inserting and/or removing a swing-bucket rotor.
- ▶ Always use both hands to carry the rotor cross.

5.9.2.2 Fitting and removing the upper shell of the wind shield

The upper shell of the wind shield is used for noise reduction.

1. Before using it for the first time, remove the attachment that is mounted to the knob of the upper shell of the wind shield.
2. Fit the upper shell of the wind shield and turn in by max. 1/4 of a turn until it is lowered onto the rotor hub.

The lock indicator must protrude from the knob so that the red marking is clearly visible:

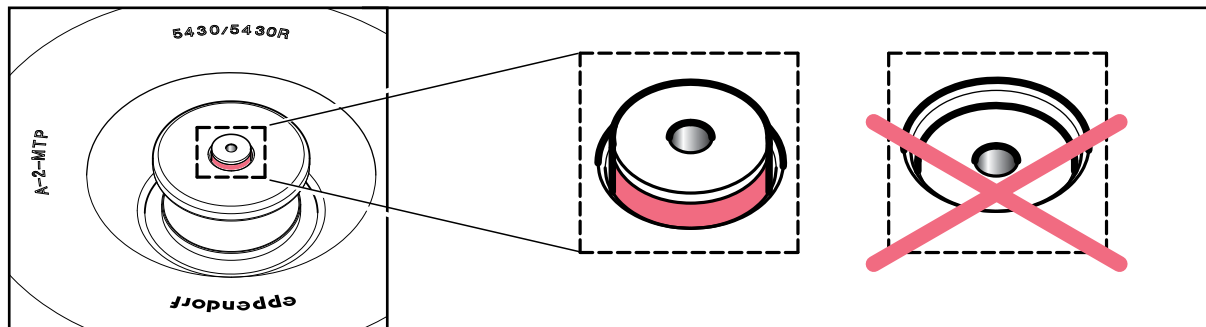

The loose fit of the upper shell is intended and facilitates self-centering.

3. Pull on the knob of the upper shell of the wind shield in order to lift it.



5430 R only: When using the A-2-MTPs, centrifuge without the upper shell of the wind shield in order to ensure precise and quick temperature control of the samples. Note that the centrifugation noise will increase slightly in this case.

This does not apply to the S-24-11-AT. The S-24-11-AT must always be operated with a rotor lid.

5.9.3 Rotor FA-45-24-11-HS: Using the special rotor key

5.9.3.1 Tightening the rotor

1. Insert the rotor key for rotor FA-45-24-11-HS in the rotor nut.
2. Turn the rotor key in clockwise direction until it slips ('click').
The rotor is correctly tightened.

5.9.3.2 Loosening the rotor

- ▶ Turn the rotor nut with the rotor key for rotor FA-45-24-11-HS in counterclockwise direction.



The rotor key for rotor FA-45-24-11-HS can only be used to tighten or loosen this rotor. For the other rotors described in this operating manual, use the rotor key that is delivered with the Centrifuge 5430 / 5430 R.

5.9.4 QuickLock

The aerosol-tight rotors FA-45-48-11, FA-45-30-11, FA-45-24-11-Kit, FA-45-16-17 and S-24-11-AT are equipped with a rotor lid quick lock (QuickLock).

The rotors FA-45-30-11 and FA-45-24-11-Kit were redesigned and are now equipped with a quick lock (QuickLock) only instead of a rotor lid with thread.

Closing the rotor lid

1. Check the correct positioning of the external sealing ring in the groove.
2. Place the rotor lid on the rotor in a vertical motion.
3. To lock the rotor, turn the red rotor lid screw clockwise as far as it will go, and after an audible "click" is heard.



The rotor is only properly locked after the audible "click" is heard!

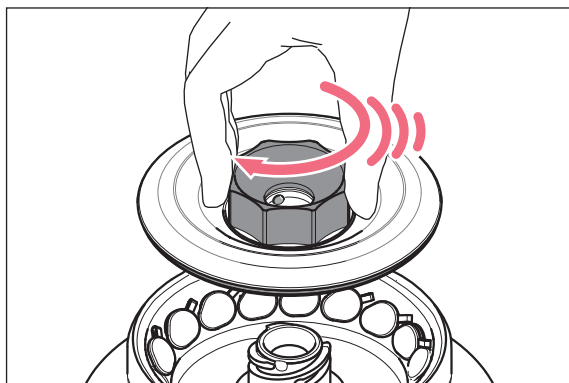

If the locking system is stiff, lightly lubricate the pins in the rotor lid screw and the rotor lid seal with pivot grease.

5.9.5 Rotor: S-24-11-AT: Use with centrifuge 5430

From software version 4.4 onwards, no retrofitting is required to use the rotors. Retrofitting of older devices is possible from serial number 10.000 onwards. Retrofitting must only be carried out by an authorized service technician.

1. Have retrofitting done, if required.

5.9.6 Rotor: S-24-11-AT: Use with centrifuge 5430 R

From software version 1.5 onwards, no retrofitting is required to use the rotors in Centrifuge 5430 R. Exception: Devices with software version 2.0 and 2.1 need to be retrofitted. All devices can be retrofitted. The software version of the device is shown on the screen after switching the device on. Retrofitting must only be carried out by a trained service technician.

1. Have retrofitting done, if required.

5.10 Information on aerosol-tight centrifugation



WARNING! Damage to health due to limited aerosol tightness if an incorrect rotor/rotor lid combination is used.

Aerosol-tight centrifugation is only guaranteed if the rotors and rotor lids intended for this purpose are used. The designation of aerosol-tight fixed-angle rotors always starts with **FA**. The aerosol-tight rotors and rotor lids of this centrifuge are also marked with a red ring on the rotor and a red rotor lid screw.

- ▶ Always use rotors and rotor lids marked as aerosol-tight together for aerosol-tight centrifugation. The details specifying in which centrifuge the aerosol-tight rotors and rotor lids may be used can be found on the rotor and on the top of the rotor lid.
- ▶ Only use aerosol-tight rotor lids in combination with the rotors indicated on the rotor lid.



WARNING! Damage to health due to limited aerosol tightness if used incorrectly.

Mechanical stresses and contamination by chemicals or other aggressive solvents may impair the aerosol tightness of the rotors and rotor lids. Autoclaving at excessively high temperatures can lead to plastic tubes, adapters and rotor lids becoming brittle and deformed.

- ▶ Check the integrity of the seals of the aerosol-tight rotor lids or caps before each use.
- ▶ Only use aerosol-tight rotor lids or caps if the seals are undamaged and clean.
- ▶ Do not exceed temperatures of 121 °C or a time of more than 20 min. when autoclaving.
- ▶ After each proper autoclaving process (121 °C, 20 min.), coat the threads of the rotor lid screw with a thin layer of pivot grease (order no. Int. 5810 350.050, North America 022634330).
- ▶ Replace aerosol-tight rotor lids without replaceable seals after 50 autoclaving cycles.
- ▶ On aerosol-tight rotor lids with exchangeable seals (e.g. QuickLock rotor lids) the seal only needs to be replaced after 50 autoclaving cycles.
- ▶ **Never** close aerosol-tight rotors or buckets for storage.



The aerosol tightness of rotors, rotor lids, buckets and caps has been tested and certified according to Annex AA of IEC 61010-2-020.

5.10.1 Aerosol-tight centrifugation in a fixed-angle rotor

To ensure aerosol tightness, the following applies:

- Replace aerosol-tight rotor lids without exchangeable seal and cap after 50 autoclaving cycles.
- Replace the seal of aerosol-tight rotor lids with exchangeable seal (e.g., QuickLock rotor lids) after 50 autoclaving cycles.
- Lightly grease the replaced seal with pivot grease after it is inserted.

6 Maintenance

6.1 Service options

Eppendorf recommends having your device checked and maintained by trained specialist personnel at regular intervals.

Eppendorf offers you tailor-made service solutions for the preventive maintenance, qualification and calibration of your device. For information, offers and contact options, please visit www.eppendorf.com/epservices.

6.2 Service



WARNING! Risk of fire or electrical shock

- ▶ Have the centrifuge's electrical safety, especially the continuity of the protective connections, checked every 12 months by trained and skilled personnel.

6.3 Prepare cleaning/disinfection

The procedure described in the following chapter applies to the cleaning as well as to the disinfection or decontamination. The table below describes the steps required on top of this:

Cleaning	Disinfection/decontamination
<ol style="list-style-type: none"> 1. Use a mild cleaning fluid to clean the accessible surfaces of the device and the accessories. 2. Carry out the cleaning as described in the following chapter. 	<ol style="list-style-type: none"> 1. Choose the disinfection method which corresponds to the legal regulations and guidelines in place for your range of application. For example, use alcohol (ethanol, isopropanol) or alcohol-based disinfectants. 2. Carry out the disinfection or decontamination as described in the following chapter. 3. Then clean the device and the accessories.



If you have any further questions regarding cleaning and disinfection or decontamination or regarding the cleaning agents to be used, contact the Application Support of Eppendorf SE. The contact details are provided on the back of this manual.

6.4 Cleaning/disinfection



DANGER! Electric shock due to the ingress of liquid.

- ▶ Switch off the device and disconnect it from the mains/power line before commencing any cleaning or disinfection procedures.
 - ▶ Do not allow any liquids to enter the inside of the housing.
 - ▶ Do not spray clean or spray disinfect the housing.
 - ▶ Do not reconnect the device to the mains/power line unless both the inside and outside of the device are completely dry.
-



NOTICE! Damage due to aggressive chemicals.

- ▶ Do not use any aggressive chemicals on the device or its accessories, such as strong and weak bases, strong acids, acetone, formaldehyde, halogenated hydrocarbons or phenol.
- ▶ If the device has been contaminated by aggressive chemicals, clean it immediately using a mild cleaning agent.



NOTICE! Corrosion due to aggressive cleaning agents and disinfectants.

- ▶ Do not use any corrosive cleaning agents, aggressive solvents or abrasive polishes.
- ▶ Do not incubate the accessories in aggressive cleaning agents or disinfectants for longer periods.



NOTICE! Damage from UV and other high-energy radiation.

- ▶ Do not use UV, beta or gamma rays, or any other high-energy forms of radiation for disinfection.
- ▶ Avoid storage in areas with high UV radiation.



NOTICE! Danger due to deformed or brittle tubes. Autoclaving at excessively high temperatures can lead to plastic vessels becoming brittle and deformed.

This could result in damage to the device and the accessories and sample loss.

- ▶ Observe the temperatures specified by the manufacturer when autoclaving tubes.
 - ▶ Do not use any deformed or brittle tubes.
-



Autoclaving

All rotors, rotor lids and adapters, except rotor A-2-MTP, can be autoclaved (121 °C, 20 min). Replace the lids of the aerosol-tight rotors after a maximum of 50 autoclaving cycles.

Aerosol-tight rotor lids with a replaceable seal (e.g., QuickLock rotor lids) only: Only the seal needs to be replaced after a maximum of 50 autoclaving cycles.



Swing-bucket rotors

- Before cleaning the rotor, remove old pivot grease from grooves and pegs.
- Make sure that the grooves and pegs are clean. Contaminated grooves and pegs prevent carriers from swinging out evenly.
- After cleaning, lightly lubricate the pegs of the rotor and the grooves of the buckets with pivot grease (order no. int.: 5810 350.050/North America: 022634330) so that the buckets can move freely in a swinging motion.

6.4.1 Cleaning and disinfecting the device

1. Open the lid. Switch off the device using the mains/power switch. Disconnect the mains/power plug from the voltage supply.
2. Loosen the rotor nut by turning the rotor key **counterclockwise**.
3. Remove the rotor.
4. Clean and disinfect all accessible surfaces on the device including the mains/power cord using a damp cloth and the recommended cleaning agents.
5. Thoroughly clean the rubber seals of the rotor chamber with water.
6. Rub the dry rubber seal with glycerol or talcum powder to prevent it from becoming brittle. Other components of the device, such as the lid latch, lid springs, motor shaft and rotor cone, must not be lubricated.
7. Clean the motor shaft using a soft, dry, lint-free cloth. Do not grease the motor shaft.
8. Check the motor shaft for any damage.
9. Inspect the device for any corrosion and damage.
10. Leave the centrifuge lid open when the device is not in use.
11. Only reconnect the device to the mains/power supply if it is fully dry on the inside and on the outside.

6.4.2 Cleaning and disinfecting the rotor

1. Inspect the rotor and accessories for any damage and corrosion. Do not use any damaged rotors or accessories.
2. Clean and disinfect the rotors and accessories using the recommended cleaning agents.
3. Use a bottle brush to clean and disinfect the rotor bores.
4. Clean and disinfect the rotor lids. **QuickLock ONLY:** The sealing ring must be removed to ensure that the groove below is cleaned thoroughly.

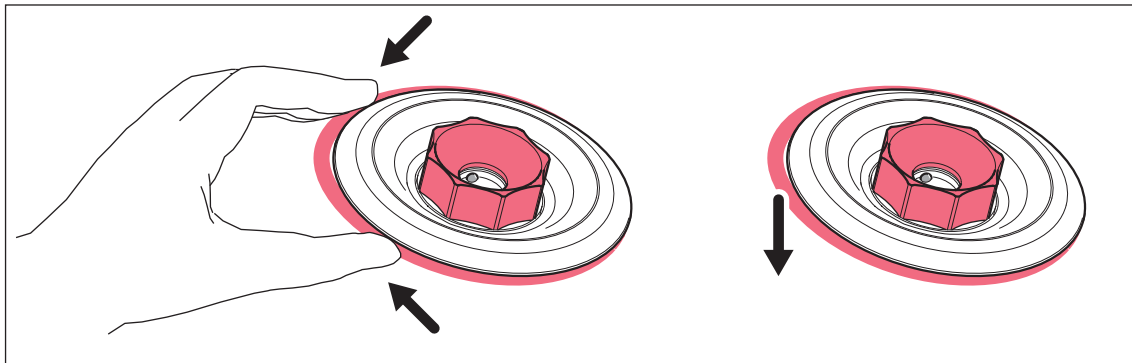

5. Rinse the rotors and accessories thoroughly with distilled water. Rinse the rotor bores of fixed-angle rotors particularly thoroughly.



Do not put the rotor into the dishwasher and do not immerse the rotor in liquid, as liquid may enter through the openings.

6. Place the rotors and accessories on a towel to dry. Place fixed-angle rotors with the rotor bores facing down so the bores can also dry.
7. Reinsert the sealing ring of the rotor lid correctly into the clean and dry groove and grease it lightly with pivot grease.
8. Clean the rotor cone with a soft, dry, lint-free cloth. Do not lubricate the rotor cone.
9. Inspect the rotor cone for damage.
10. Place the dry rotor onto the motor shaft.
11. Tighten the rotor nut firmly by turning it **clockwise** with the rotor key.
12. Load the fixed-angle rotor with the cleaned adapters or the swing-bucket rotor with the cleaned buckets and adapters, if necessary.
13. Leave the rotor lid open when the rotor is not being used.

6.5 Additional care instructions for refrigerated centrifuges.

- ▶ The condensation water outlet also needs to be cleaned on a regular basis, e.g., using a bottle brush.
- ▶ Regularly clear the rotor chamber of ice formations via defrosting, either by leaving the centrifuge lid open or carrying out a brief temperature control run at approx. 30°C.
- ▶ Wipe up condensation water in the rotor chamber. Use a soft absorbent cloth for this.
- ▶ No later than every 6 months, remove any dust deposits from the ventilation gaps of the centrifuge using a brush or swab. First switch off the centrifuge and remove the mains/power plug.
- ▶ Regularly check the gas spring of the centrifuge lid for proper functioning.
A defective gas spring is an insufficient support for the centrifuge lid and could cause injury if the centrifuge lid falls down. We recommend that the gas spring be replaced by a service technician every 2 years.

6.6 Cleaning glass breakage

When using glass tubes there is a risk of glass breakage in the rotor chamber. The resulting glass splinters are swirled around in the rotor chamber during centrifugation and have a sandblasting effect on the rotor and accessories. Very small particles of glass can become lodged in the rubber parts (e.g., the motor sleeve, the rotor chamber seal, and the rubber mats of adapters).



NOTICE! Glass breakage in the rotor chamber

Glass tubes in the rotor chamber may break if the *g*-force is too high. Broken glass can damage the rotor, accessories and samples.

- ▶ Please note the manufacturer's information on the recommended centrifugation parameters (load and speed).

Effects of glass breakage in the rotor chamber:

- Fine black metal abrasion dust in the rotor chamber (with metal rotor bowls).
- The surfaces of the rotor chamber and accessories are scratched.
- The chemical resistance of the rotor chamber is reduced.
- Contamination of samples.
- Wear on rubber parts.

How to proceed in case of glass breakage

1. Remove all splinters and glass powder from the rotor chamber and accessories.
2. Thoroughly clean the rotor and rotor chamber. Thoroughly clean the bores of the fixed-angle rotors, in particular.
3. If required, replace the rubber mats and adapters to prevent any further damage.
4. Regularly check the rotor bores for deposits and damage.

6.7 Fuses

The fuse holder is located under the mains power socket.

1. Pull out the power plug.
2. Remove the fuse holder towards the rear.

The two fuses can now be reached. The fuses can be replaced.

Instead of removable fuses, the Centrifuge 5430 R features a thermal overcurrent protective switch. The mains power switch jumps to the '0' switch setting if the overcurrent protective switch is triggered.

1. Use the mains power switch to switch the device back on after more than 20 s.

6.8 Decontamination before shipment

If you are shipping the device to the authorized Technical Service for repairs or to your authorized dealer for disposal please note the following:



WARNING! Risk to health from contaminated device.

1. Observe the information contained in the decontamination certificate. It is available as a PDF document on our webpage (<https://www.eppendorf.com/decontamination>).
 2. Decontaminate all parts to be shipped.
 3. Include the fully completed decontamination certificate in the shipment.
-

7 Troubleshooting

If you cannot remedy an error with the recommended measures, please contact your local Eppendorf partner. The contact address can be found on the Internet at www.eppendorf.com.

7.1 General errors

Problem	Cause	Solution
No display.	No mains/power connection.	▶ Check the mains/power connection.
	Mains/power outage.	▶ Check the fuse of the centrifuge. ▶ Check the mains/power fuse of the lab.
Centrifuge lid cannot be opened.	The rotor is still running.	▶ Wait for the rotor to stop.
	Mains/power outage.	1. Check the fuse of the centrifuge. 2. Check the mains/power fuse of the lab. 3. Activate the emergency lid release.
Centrifuge cannot be started.	The centrifuge lid is not closed.	▶ Close the centrifuge lid.
Centrifuge shakes when it starts up.	The rotor is loaded asymmetrically.	1. Stop the centrifuge and load symmetrically. 2. Restart the centrifuge.
Centrifuge brakes during a short run centrifugation, although the short key is pressed.	The short key was released briefly more than twice (protective function for the drive).	▶ Press the short key continuously during a short run centrifugation. ▶ Briefly press the short key.
Temperature display flashes. (only 5430 R)	Temperature deviation from set value: ± 3 °C.	▶ Check the settings. ▶ Check unhindered air circulation through the air slots. ▶ Thaw ice or switch off the centrifuge and allow it to cool down.

7.2 Error messages

If one of the following error messages appears, proceed as follows:

1. Remove fault (see Remedies).
2. Press **open** key to clear the error message.
3. If necessary, repeat centrifugation.

Some errors can have various causes. The actual cause is described in the message in the device display.

Problem	Cause	Solution
<i>Note A</i> <i>Lid latch</i>	Centrifuge lid could not be locked.	▶ Try to close the centrifuge lid again.
<i>Note B</i> <i>Imbalance</i>	The rotor is loaded asymmetrically.	▶ Load the rotor symmetrically and balance it.
<i>Note C</i> <i>Rotor detection</i>	Set g-force/speed too high, e.g., after a rotor change(see <i>Automatic rotor detection on p. 34</i>).	1. Check the g-force/speed. 2. Repeat the run.

Problem	Cause	Solution
<i>Error 1</i> <i>Rotor detection</i>	Rotor not detected.	▶ Check the rotor. ▶ If this error message appears again, test with a different rotor.
<i>Error 2</i> <i>Electronics fault</i>	Electronics fault.	▶ Switch the centrifuge off and back on again after >20 s.
<i>Error 3</i> <i>Speed check</i>	Error in the rotational speed measurement system.	▶ Insert and tighten rotor.
<i>Error 3</i> <i>Speed check</i>	Error in the rotational speed measurement system.	▶ Wait for the displayed time.
<i>Error 5</i> <i>Lid latch</i>	Prohibited opening of lid or lid switch is defective during a run.	1. Wait for the rotor to stop. 2. Open the centrifuge lid and then close it again. 3. Repeat the run.
<i>Error 6</i> <i>Drive fault</i>	Drive fault.	▶ Repeat the run. ▶ If this error message appears again, switch centrifuge off and back on again after >20 s.
	The drive is overheated.	▶ Allow the drive to cool down for at least 15 min.
<i>Error 7</i> <i>Speed check</i>	Major deviation in the speed check.	1. Wait for the rotor to stop. 2. Tighten the rotor.
<i>Error 8</i> <i>Speed check</i>	<ul style="list-style-type: none"> • Drive fault. • Rotor loose. • Incorrect rotor. 	1. Wait for the rotor to stop. 2. Tighten the rotor. 3. Repeat the run.

Problem	Cause	Solution
<i>Error 9 to Error 14</i>	Electronics fault.	▶ Switch the centrifuge off and back on again after >20 s.
<i>Error 16 to Error 17</i> <i>Electronics fault</i>	Electronics fault.	▶ Switch the centrifuge off and back on again after > 20 s.
<i>Error 18</i> <i>Rotor chamber</i> <i>temperature</i> <i>(5430 R only)</i>	Temperature deviation from set value in the rotor chamber: $\Delta T > 16 \text{ }^\circ\text{C}$.	▶ Allow the centrifuge to cool down and repeat the run.
<i>Error 18</i> <i>Rotor chamber</i> <i>temperature</i> <i>(5430 R only)</i>	Temperature deviation from set value in the rotor chamber: $T > 50 \text{ }^\circ\text{C}$.	▶ Allow the centrifuge to cool down and repeat the run.
<i>Error 22</i> <i>Electronics fault</i> <i>(5430 R only)</i>	Electronics fault.	▶ Switch the centrifuge off and back on again after > 20 s.
<i>Error 25</i> <i>Mains/power failure</i>	Mains/power failure during a run.	▶ Check the mains/power supply.
<i>Error 26</i> <i>Electronics fault</i> <i>(5430 R only)</i>	Electronics fault.	▶ Switch the centrifuge off and back on again after > 20 s.
<i>Error 27</i> <i>Electronics fault</i> <i>(5430 R only)</i>	Electronics fault.	▶ Switch the centrifuge off and back on again after > 20 s.
<i>Error 28</i> <i>Electronics fault</i>	Electronics fault.	▶ Press the open key.
<i>Error 30</i> <i>Lid latch</i>	Centrifuge lid could not be locked.	▶ Try to close the centrifuge lid again.
<i>Error 30</i> <i>Lid latch</i>	Centrifuge lid could not be released.	▶ Switch the centrifuge off and back on. If the error occurs again: 1. Switch off the centrifuge. 2. Activate the emergency lid release (see <i>Emergency release on p. 60</i>).
<i>Error 30</i> <i>Lid latch</i>	The centrifuge lid has not been opened wide enough.	▶ Open the centrifuge lid wider by hand.

7.3 Emergency release

If the centrifuge lid cannot be opened, you can activate the emergency release manually.



WARNING! Risk of injury from rotating rotor.

If the emergency release of the lid is operated, the rotor may continue to rotate for several minutes.

- ▶ Wait for the rotor to stop before activating the emergency release.
- ▶ To check, look through the monitoring glass in the centrifuge lid.



Use the rotor key delivered with the Centrifuge 5430 for the emergency release.
The rotor key for the rotor FA-45-24-11-HS is not suitable for this purpose.

1. Disconnect the mains/power plug.
2. Carry out the following steps for the emergency release on both the left side and right side of the centrifuge (see Fig. 1 and Fig. 2).
3. **Only 5430:** Remove the plastic cover for the emergency release.
4. Insert the centrifuge rotor key in the rear hexagonal opening until a noticeable resistance is felt.
5. **Slightly press** and turn the rotor key counterclockwise five to ten revolutions, as depicted on the openings of the emergency release.
This will release the centrifuge lid.
6. Open the centrifuge lid.
7. Remove the rotor key and put the plastic covers back on (Centrifuge 5430).

8 Transport, storage and disposal

8.1 Transport



CAUTION! Risk of injury due to lifting and carrying heavy loads

The device is heavy. Lifting and carrying the device can lead to back injuries.

- ▶ Transport and lift the device with an adequate number of helpers.
- ▶ Use a transport aid for transporting the device.

- ▶ Remove the rotor from the centrifuge before transport.
- ▶ Use the original packaging and the transport securing devices for transport.

	Air temperature	Relative humidity	Atmospheric pressure
General transport	-25 °C – 60 °C	10 % – 75 %	30 kPa – 106 kPa
Air freight	-20 °C – 55 °C	10 % – 75 %	30 kPa – 106 kPa

8.2 Storage

	Air temperature	Relative humidity	Atmospheric pressure
In transport packing	-25 °C – 55 °C	10 % – 75 %	70 kPa – 106 kPa
Without transport packing	-5 °C – 45 °C	10 % – 75 %	70 kPa – 106 kPa

8.3 Disposal

Observe the relevant legal regulations when disposing of the product.

Information on the disposal of electrical and electronic devices in the European Community:

Within the European Community, the disposal of electrical devices is regulated by national regulations based on EU Directive 2012/19/EU pertaining to waste electrical and electronic equipment (WEEE).

According to these regulations, any devices supplied after August 13, 2005, in the business-to-business sphere, to which this product is assigned, may no longer be disposed of in municipal or domestic waste. They are marked with the following symbol to indicate this:

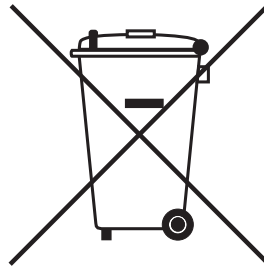

As the disposal regulations may differ from one country to another within the EU, please contact your supplier for more information.

9 Technical data

9.1 Power supply

Centrifuge 5430

Mains/power connection	230 V, 50 to 60 Hz 120 V, 50 to 60 Hz 100 V, 50 to 60 Hz
Current consumption	3 A (230 V) 6 A (120 V) 7 A (100 V)
Power consumption	Maximum 475 W
EMC: Noise emission (radio interference)	230 V: EN 61326-1/EN 55011 – Class A 120 V: CFR 47 FCC Part 15 – Class A 100 V: EN 61326-1/EN 55011 - Class A
EMC: Noise immunity	EN 61326-1
Overvoltage category	II
Protection class	1
Fuses	250 V 4 A T HBC (230 V) 250 V 8 A T HBC (120 V) 250 V 8 A T HBC (100 V)
Pollution degree	2

Centrifuge 5430 R

Mains/power connection	230 V, 50 to 60 Hz 120 V, 50 to 60 Hz 100 V, 50 to 60 Hz
Current consumption	6 A (230 V) 12 A (120 V) 12 A (100 V)
Power consumption	Maximum 1050 W
EMC: Noise emission (radio interference)	230 V: EN 61326-1/EN 55011 – Class A 120 V: CFR 47 FCC Part 15 – Class A 100 V: EN 61326-1/EN 55011 – Class A
EMC: Noise immunity	EN 61326-1
Overvoltage category	II
Protection class	1
Pollution degree	2

9.2 Ambient conditions

Environment	For indoor use only. The surroundings must not be moist.
Ambient temperature	5430: 4 °C – 40 °C 5430 R: 10 °C – 35 °C
Relative humidity	10 % – 75 %, non-condensing.
Atmospheric pressure	79,5 kPa – 106 kPa

9.3 Weight/dimensions

Centrifuge 5430

Dimensions	Width: 335 mm Depth: 415 mm Height: 250 mm
Weight without rotor	29 kg

Centrifuge 5430 R

Dimensions	Width: 380 mm Depth: 640 mm Height: 296 mm
Weight without rotor	56 kg

*) The noise level was measured frontally in a sound measuring room with accuracy class 1 at a distance of 1 m from the device and at lab bench height.

Rotor weights:		Accessories without caps:	
S-24-11-AT	1340 g	Bucket	27 g
FA-45-48-11	2110 g		
F-45-48-11	1770 g		
FA-45-16-17	2050 g		
FA-45-30-11	1500 g		
FA-45-24-11-Kit	1600 g		
F-45-30-11	1020 g		
FA-45-24-11-HS	2800 g		
F-35-6-30	3900 g		
F-45-64-5-PCR	1230 g		
F-45-18-17-Cryo	1080 g		
A-2-MTP	3100 g	Bucket	540 g

9.4 Noise level

The noise level was measured in a sound measuring room with accuracy class 1 (DIN EN ISO 3745), frontally, at a distance of 1 m from the device and at lab bench height.

Noise level	< 56 dB(A)
-------------	------------

9.5 Application parameters

Run time	30 s to 99:59 h, infinity (∞) Adjustable to 10 min in 0.5 min increments, then increments of 1 min.
Temperature of 5430 R	-11°C to 40°C
Relative centrifugal force (or rcf)	1 to 30,130 x g Adjustable in increments of 10 x g up to 3,000 x g, then in increments of 100 x g
Rotational speed	100 to 17,500 rpm Adjustable in increments of 10 rpm up to 5,000 rpm, then in increments of 100 rpm
Maximum load	48 tubes with 2.0 mL each or 6 conical tubes with 50 mL each
Maximum kinetic energy	10,000 J
Compulsory test log book	No
Permitted density of the material for centrifuging at max. g-force/rpm and max. load	1.2 g/mL

Rotor	Lowest achievable temperature -11°C set 23°C ambient temperature 60 min run time	Speed to safely maintain 4°C sample temperature 4°C set 23 °C ambient temperature
FA-45-48-11	< 0 °C	12 700 rpm
F-45-48-11	< 0 °C	12700 rpm
FA-45-30-11	< 0 °C	14 000 rpm
F-45-30-11	< 0 °C	14000 rpm
FA-45-24-11-HS	< 5 °C	17 500 rpm
FA-45-24-11-Kit	< 0 °C	13200 rpm
F-45-64-5-PCR	< 0 °C	11800 rpm
F-45-18-17-Cryo	< 0 °C	8900 rpm
FA-45-16-17	< 0 °C	14200 rpm
F-35-6-30	< 0 °C	7830 rpm
A-2-MTP	< 0 °C	4680 rpm
S-24-11-AT	< 0 °C	12700 rpm

9.6 Acceleration and deceleration times

The following table contains acceleration times and deceleration times for the rotors of the Centrifuge 5430 / 5430 R. The details were determined with the rotor at maximum load, for swing-bucket rotors with round bucket. Fluctuations may occur depending on the condition of the device and the load.

- Level 9: shortest acceleration time/deceleration time
- Level 0: longest acceleration time/deceleration time (with the brake off)

Rotor	Acceleration time/Deceleration time Without soft ramp		
	Acceleration time/Deceleration time With soft ramp		
	230 V	120 V	100 V
FA-45-48-11	≤ 20 s/20 s	≤ 20 s/20 s	≤ 27 s/20 s
F-45-48-11	≤ 61 s/65 s (SOFT)	≤ 61 s/65 s (SOFT)	≤ 61 s/65 s (SOFT)
FA-45-30-11	≤ 15 s/15 s	≤ 15 s/15 s	≤ 20 s/15 s
F-45-30-11	≤ 61 s/65 s (SOFT)	≤ 61 s/65 s (SOFT)	≤ 61 s/65 s (SOFT)
FA-45-24-11-Kit	≤ 15 s/16 s ≤ 78 s/90 s (SOFT)	≤ 15 s/16 s ≤ 78 s/90 s (SOFT)	≤ 20 s/16 s ≤ 78 s/90 s (SOFT)
FA-45-16-17	≤ 20 s/20 s ≤ 61 s/66 s (SOFT)	≤ 20 s/20 s ≤ 61 s/66 s (SOFT)	≤ 30 s/20 s ≤ 61 s/66 s (SOFT)
S-24-11-AT	≤ 13 s/16 s ≤ 61 s/66 s (SOFT)	≤ 13 s/16 s ≤ 61 s/66 s (SOFT)	≤ 16 s/16 s ≤ 61 s/66 s (SOFT)
FA-45-24-11-HS	≤ 21 s/16 s ≤ 60 s/65 s (SOFT)	≤ 21 s/16 s ≤ 60 s/65 s (SOFT)	≤ 30 s/16 s ≤ 60 s/65 s (SOFT)
F-45-64-5-PCR	≤ 12 s/15 s ≤ 62 s/65 s (SOFT)	≤ 12 s/15 s ≤ 62 s/65 s (SOFT)	≤ 15 s/15 s ≤ 62 s/65 s (SOFT)
F-45-18-17-Cryo	≤ 8 s/11 s ≤ 77 s/85 s (SOFT)	≤ 8 s/11 s ≤ 77 s/85 s (SOFT)	≤ 8 s/11 s ≤ 77 s/85 s (SOFT)
F-35-6-30	≤ 23 s/23 s ≤ 62 s/67 s (SOFT)	≤ 23 s/23 s ≤ 62 s/67 s (SOFT)	≤ 27 s/27 s ≤ 62 s/67 s (SOFT)
A-2-MTP	≤ 18 s/21 s ≤ 63 s/67 s (SOFT)	≤ 18 s/21 s ≤ 63 s/67 s (SOFT)	≤ 18 s/21 s ≤ 63 s/67 s (SOFT)

9.7 Accessory service life



CAUTION! Danger due to material fatigue.

If the service life is exceeded, it cannot be guaranteed that the material of the rotors and the accessories will withstand the stresses during centrifugation.

- ▶ Do not use any accessories which have exceeded their maximum service life.

Eppendorf states the maximum service life of rotors and accessories in cycles and years. The number of cycles is decisive. If determination of the number of cycles is not possible, the service life in years applies.

Each centrifugation run during which the rotor is accelerated and braked is counted as a cycle, independent of the speed and the duration of the centrifugation run.

For the following rotors, the service life is based on the following standard laboratory day: Use for 25 cycles per day on 5 days a week, 52 weeks a year.

Rotor		Centrifuge	Max. service from the first commissioning onward	
			in cycles	in years
QuickLock	Rotor lid with thread			
FA-45-48-11		5430, 5430 R	100000	15
FA-45-30-11		5430, 5430 R	100000	15
FA-45-24-11-Kit		5430, 5430 R	100000	15
FA-45-16-17		5430, 5430 R	100000	15
F-35-6-30		5430, 5430 R	75000	10
F-45-64-5-PCR		5430, 5430 R	75000	10
S-24-11-AT		5430, 5430 R	100000	15
	A-2-MTP including corresponding bucket and upper shell of the wind shield	5430, 5430 R	100000	15

Unless stated otherwise (in the manual of the centrifuge, indication of the number of cycles on the rotor, in the instructions for use of the rotor), all other rotors and rotor lids can be used over the entire service life of the centrifuge if the following prerequisites are met:

- proper use
- recommended maintenance
- undamaged condition

Accessories	Max. service from the first commissioning onward
Aerosol-tight rotor lids with exchangeable seal (e.g., QuickLock rotor lids)	3 years (replace seals every 50 autoclaving cycles)
Aerosol-tight rotor lids without exchangeable seal	3 years or 50 autoclaving cycles, whichever occurs first
Non-aerosol-tight rotor lids	3 years
Aerosol-tight caps made of PP, PC, PEI	3 years or 50 autoclaving cycles, whichever occurs first
Adapter	1 year

The date of manufacture is stamped on the rotors in the format *03/15* or *03/2015* (= March 2015). On the inside of the plastic rotor lid, the date of manufacture is stamped in the form of a clock🕒.

To ensure aerosol tightness, the following applies:

- ▶ Replace aerosol-tight rotor lids without exchangeable seal and cap after 50 autoclaving cycles.
- ▶ Replace the seal of aerosol-tight rotor lids with exchangeable seal (e.g., QuickLock rotor lids) after 50 autoclaving cycles.

10 Rotors for the Centrifuge 5430 / 5430 R

10.1 Rotors

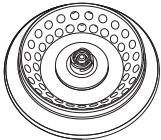
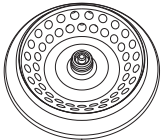
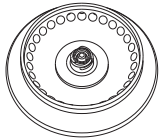

The Centrifuge 5430 / 5430 R can be operated with the following rotors. When using sample tubes, observe the manufacturers' information regarding centrifugation stability (max. *g*-force).

	Max. capacity	Max. <i>g</i> -force (rcf)/ speed (rpm) without adapter	Max. load per rotor bore ⁽¹⁾	Notes
		Acceleration/ deceleration time ⁽²⁾ (soft): with soft ramp		
Rotor FA-45-48-11 With aerosol-tight QuickLock rotor lid 	48 micro test tubes for 1.5/ 2.0 mL. With adapters: • 0.2 mL PCR tubes • 0.4 mL micro test tubes • 0.5 mL micro test tubes • 0.6 mL Microtainers	Outer row: 18,213 × <i>g</i> Inner row: 16,048 × <i>g</i> / 12,700 rpm	3.75 g	• Aerosol-tight ⁽³⁾ QuickLock rotor lid (aluminum)
		≤ 20 s/20 s ≤ 61 s/65 s (soft)		
Rotor F-45-48-11 With polypropylene rotor lid 	48 micro test tubes for 1.5/ 2.0 mL. With adapters: • 0.2 mL PCR tubes • 0.4 mL micro test tubes • 0.5 mL micro test tubes • 0.6 mL Microtainers	Outer row: 18,213 × <i>g</i> Inner row: 16,048 × <i>g</i> / 12,700 rpm	3.75 g	
		≤ 20 s/20 s ≤ 61 s/65 s (soft)		
Rotor FA-45-30-11 With aerosol-tight QuickLock rotor lid 	30 micro test tubes for 1.5/ 2.0 mL. With adapters: • 0.2 mL PCR tubes • 0.4 mL micro test tubes • 0.5 mL micro test tubes • 0.6 mL Microtainers	25,000 × <i>g</i> / 15,350 rpm	3.75 g	• Aerosol-tight ⁽³⁾ QuickLock rotor lid (aluminum).
		≤ 15 s/15 s ≤ 61 s/65 s (soft)		

Rotors for the Centrifuge 5430 / 5430 R

Centrifuge 5430/5430 R

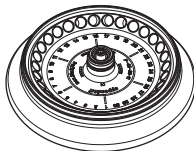
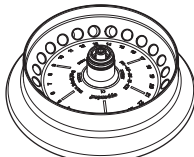
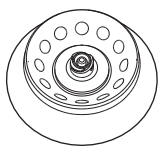
English (EN)

	Max. capacity	Max. g-force (rcf)/ speed (rpm) without adapter	Max. load per rotor bore ⁽¹⁾	Notes
		Acceleration/ deceleration time ⁽²⁾ (soft): with soft ramp		
Rotor F-45-30-11 With polypropylene rotor lid 	30 micro test tubes for 1.5/2.0 mL. With adapters: <ul style="list-style-type: none"> • 0.2 mL PCR tubes • 0.4 mL micro test tubes • 0.5 mL micro test tubes • 0.6 mL Microtainers 	20,817 × g / 14,000 rpm ≤ 15 s/15 s ≤ 61 s/65 s (soft)	3.75 g	
Rotor FA-45-24-11-Kit With aerosol-tight QuickLock rotor lid 	24 spin columns or 1.5/2.0 mL micro test tubes. With adapters: <ul style="list-style-type: none"> • 0.2 mL PCR tubes • 0.4 mL micro test tubes • 0.5 mL micro test tubes • 0.6 mL Microtainers 	19,090 × g / 13,200 rpm ≤ 15 s/16 s ≤ 78 s/90 s (soft)	3.75 g	<ul style="list-style-type: none"> • Aerosol-tight⁽³⁾ QuickLock rotor lid (aluminum). • Uniquely high edge, for all commercial spin columns. Also observe the note on centrifugation with open tube lids
Rotor FA-45-16-17 With aerosol-tight QuickLock rotor lid 	16 micro test tubes for 5.0 mL. With adapters: <ul style="list-style-type: none"> • 16 HPLC vessels 	21,191 × g / 14,200 rpm ≤ 20 s/20 s ≤ 61 s/66 s (soft)	9.5 g	<ul style="list-style-type: none"> • Aerosol-tight⁽³⁾ QuickLock rotor lid (aluminum).
Rotor S-24-11-AT With aerosol-tight QuickLock rotor lid 	24 micro test tubes for 1.5/2.0 mL. This rotor is only intended for use with 1.5/2.0 mL micro test tubes. Spin Columns and the adapters including the corresponding tubes for 0.2 mL, 0.4 mL, 0.5 mL and 0.6 mL must not be used with this rotor.	16,049 × g / 12,700 rpm ≤ 13 s/16 s ≤ 61 s/66 s (soft)	3.75 g	<ul style="list-style-type: none"> • Aerosol-tight⁽³⁾ QuickLock rotor lid (aluminum). • The rotor must always be used with rotor lid.

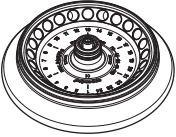
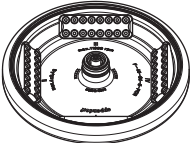
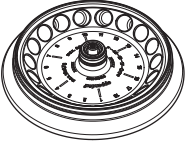
	Max. capacity	Max. g -force (rcf)/ speed (rpm) without adapter	Max. load per rotor bore ⁽¹⁾	Notes
		Acceleration/ deceleration time ⁽²⁾ (soft): with soft ramp		
Rotor FA-45-24-11-HS 	24 micro test tubes for 1.5/ 2.0 mL. With adapters: <ul style="list-style-type: none"> • 0.2 mL PCR tubes • 0.4 mL micro test tubes • 0.5 mL micro test tubes • 0.6 mL Microtainers 	30,130 × g / 17,500 rpm	3.75 g	<ul style="list-style-type: none"> • Aerosol-tight⁽³⁾ rotor lid (aluminum). • Max. g-force/speed (30,130 × g/17,500 rpm) only with tubes approved for this speed by the manufacturer. • Particularly resistant to chemicals, marked: <i>coated</i>. • Spin columns available, better with rotor FA-45-24-11-kit. • The rotor must be tightened and loosened with the special rotor key for rotor FA-45-24-11-HS
Rotor F-45-64-5-PCR 	64 PCR tubes (0.2 mL) or eight 5- or 8-PCR strips, each with the enclosed adapters.	13,808 × g / 11,800 rpm	3.4 g (without adapter)	<ul style="list-style-type: none"> • Max. g-force/speed (13,808 × g/11,800 rpm) only with tubes approved for this speed by the manufacturer. • Particularly resistant to chemicals, marked: <i>coated</i>. • Spin columns available, better with rotor F-45-64-5-PCR-kit. • The rotor must be tightened and loosened with the special rotor key for rotor F-45-64-5-PCR
Rotor F-45-18-17-Cryo 	18 cryogenic tubes or 18 sealable centrifugation tubes, max. Ø: 16.9 mm. With enclosed adapters: max. Ø: 13.4 mm, max. tube length: 50 mm.	8,324 × g / 8,900 rpm	8.7 g	<ul style="list-style-type: none"> • Max. g-force/speed (8,324 × g/8,900 rpm) only with tubes approved for this speed by the manufacturer. • Particularly resistant to chemicals, marked: <i>coated</i>. • Spin columns available, better with rotor F-45-18-17-Cryo-kit. • The rotor must be tightened and loosened with the special rotor key for rotor F-45-18-17-Cryo

Rotors for the Centrifuge 5430 / 5430 R

Centrifuge 5430/5430 R

English (EN)

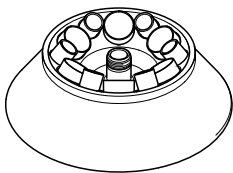
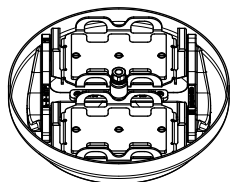
	Max. capacity	Max. g -force (rcf)/ speed (rpm) without adapter	Max. load per rotor bore ⁽¹⁾	Notes
		Acceleration/ deceleration time ⁽²⁾ (soft): with soft ramp		
Rotor F-35-6-30 	6 conical tubes for 50 mL with or without skirted bottom or 6 conical tubes for 15 mL, each with enclosed adapter, or 6 Centriplus centrifuge filter units with adapters. With adapters: <ul style="list-style-type: none"> • 6 conical tubes 50 mL with snap cap • 12 conical tubes 5 mL 	$7,745 \times g$ / 7,830 rpm	110 g	<ul style="list-style-type: none"> • The rotor must be inserted and removed using the enclosed plate carrier. • Tubes with snap cap are not aerosol-tight. • Centrifugation of dished-bottom vessels and blood collection tubes possible with additional adapters (see appendix).
Rotor A-2-MTP 	Two buckets to hold: <ul style="list-style-type: none"> • Microplates • Cell-culture plates • PCR plates • Deepwell plates (max. height 29 mm) • Slides (with CombiSlide adapter) 	$2,204 \times g$ / 4,680 rpm	170 g (per bucket)	<ul style="list-style-type: none"> • Centrifugation of PCR plates is only possible with the corresponding adapters. • Max. perm. loading height: 29 mm. • 5430 R only: More effective cooling through centrifugation without upper shell of the wind shield (see <i>Swing-bucket rotors on p. 36</i>).

(1) Maximum load per rotor bore for adapter + tube + contents.

(2) According to DIN 58 970 (device version: 230 V, 120 V and 100 V, 50 to 60 Hz).

(3) Aerosol tightness tested and certified by the Centre of Emergency Preparedness and Response, Health Protection Agency, Porton Down (UK) (see . certificates at the end of this operating manual).

For the rotors and rotor lids labeled *coated*, color fluctuations may occur as a result of the production process. These fluctuations have no effect on service life or resistance to chemicals.

10.1.1 rcf display and calculation



Use the **rpm/rcf** key to switch the display of the speed of centrifugation between **rpm** (rpm) and **g-force** (rcf). Please note that the *g*-force displayed when switching is standardized to the rotor without adapter. When using adapters, the following maximum *g*-force (rcf) can be reached at maximum speed:



Rotor F 35-6-30 is standardized for the conical 50 mL vessels with blue adapter.

Rotor	Adapter	Max. centrifugation radius r_{max} [cm]	Max. <i>g</i> -force (rcf)
Rotor FA-45-48-11/ Rotor F-45-48-11	Without adapter	Outer row: 10.1 Inner row: 8.9	Outer row: 18,210 Inner row: 16,048
	For 0.2 mL PCR tubes	Outer row: 8 Inner row: 6.8	Outer row: 14,425 Inner row: 12,261
	For 0.4 mL micro test tubes	Outer row: 10.1 Inner row: 8.9	Outer row: 18,210 Inner row: 16,048
	For 0.5 mL micro test tubes	Outer row: 9 Inner row: 7.8	Outer row: 16,229 Inner row: 14,065
	For 0.6 mL Microtainers	Outer row: 10.1 Inner row: 8.9	Outer row: 18,210 Inner row: 16,048
Rotor FA-45-30-11/ Rotor F-45-30-11	Without adapter	9.5	20,871
	For 0.2 mL PCR tubes	7.4	16,215
	For 0.4 mL micro test tubes	9.5	20,871
	For 0.5 mL micro test tubes	8.4	18,407
	For 0.6 mL Microtainers	9.5	20,817
Rotor FA-45-24-11-Kit	Without adapter	9.8	19,090
	For 0.2 mL PCR tubes	7.7	15,000
	For 0.4 mL micro test tubes	9.8	19,090
	For 0.5 mL micro test tubes	8.7	16,950
	For 0.6 mL Microtainers	9.8	19,090
Rotor FA-45-16-17	For 5.0 mL micro test tubes	9.4	21,191
Rotor S-24-11-AT	Without adapter	8.9	16,049
Rotor FA-45-24-11-HS	Without adapter	8.8	30,130
	For 0.2 mL PCR tubes	6.7	22,940
	For 0.4 mL micro test tubes	8.8	30,130
	For 0.5 mL micro test tubes	7.7	26,364
	For 0.6 mL Microtainers	8.8	30,130
Rotor F-45-64-5-PCR	For PCR strips, inner row	7.7	11,987
	For PCR strips, outer row	8.7	13,808

Rotors for the Centrifuge 5430 / 5430 R

Centrifuge 5430/5430 R
English (EN)

Rotor	Adapter	Max. centrifugation radius r_{\max} [cm]	Max. g -force (rcf)
Rotor F-45-18-17-Cryo	Without adapter	9.4	8,320
	For cryogenic tubes	9.0	7,970
Rotor F-35-6-30*	For conical tubes 5 mL	10.3 9.0	7,060 6,196
	For conical tubes 15 mL	11.0	7,540
	For conical tubes 50 mL	10.5	7,197
	For Centriplus centrifuge filter units	11.1	7,567
Rotor A-2-MTP	Without adapter	9.0	2,204
	For 384-well PCR plates	7.7	1,885
	For 96-well PCR plates	7.3	1,788
	CombiSlide adapter	7.7	1,885

*) Centrifugation of dished-bottom vessels and blood collection tubes possible with additional adapters (see table 12-1 in the appendix).

To determine the g -force (rcf) for a specific adapter, you can perform a calculation according to DIN 58 970 with the following formula:

$$\text{rcf} = 1.118 \cdot 10^{-5} \cdot n^2 \cdot r_{\max}$$

n : Speed in min^{-1} (rpm)

r_{\max} : Max. centrifugation radius in cm

Example:

In Rotor FA-45-30-11, the 0.5 mL adapter has a maximum radius of 8.4 cm. At 7,000 rpm, a maximum g -force of $4,600 \times g$ is achieved.

11 Ordering Information

11.1 Rotors, rotor lids and gaskets

11.1.1 Rotors with QuickLock rotor lid

Rotor FA-45-48-11

Order no. (International)	Order no. (North America)	Description
5427 754.008	5427754008	Fixed-angle rotor FA-45-48-11 aerosol-tight, angle 45°, 48 places, max. tube diameter 11 mm, incl. rotor lid (aluminum)
5427 762.000	5427762000	Rotor lid for FA-45-48-11 aerosol-tight, aluminum
5820 767.006	5820767006	Seal for rotor lid FA-45-24-11-Kit (5427 R/530/5430 R), FA-45-48-11 (5427 R/5430/5430 R, 5804/5804 R/5810/5810 R), FA-30x2 (5910 R, 5920 R, 5910 Ri), FA-48x2 (5910 R, 5920 R, 5910 Ri) 5 pieces

Rotor FA-45-30-11

Order no. (International)	Order no. (North America)	Description
5427 753.001	5427753001	Fixed-angle FA-45-30-11 aerosol-tight, angle 45°, 30 places, max. tube diameter 11 mm, incl. rotor lid (aluminum)
5427 761.004	5427761004	Rotor lid for FA-45-30-11 aerosol-tight, aluminum
5820 762.004	5820762004	Seal for rotor lid FA-45-30-11 (5427 R/5430/5430 R) 5 pieces

Rotor FA-45-24-11 kit

Order no. (International)	Order no. (North America)	Description
5427 752.005	5427752005	Fixed-angle rotor FA-45-24-11-Kit aerosol-tight, angle 45°, 24 places, max. tube diameter 11 mm, incl. rotor lid (aluminum)
5427 760.008	5427760008	Rotor lid for FA-45-24-11-Kit aerosol-tight, aluminum
5820 767.006	5820767006	Seal for rotor lid FA-45-24-11-Kit (5427 R/530/5430 R), FA-45-48-11 (5427 R/5430/5430 R, 5804/5804 R/5810/5810 R), FA-30x2 (5910 R, 5920 R, 5910 Ri), FA-48x2 (5910 R, 5920 R, 5910 Ri) 5 pieces

Rotor FA-45-16-17

Order no. (International)	Order no. (North America)	Description
5427 750.002	5427750002	Fixed-angle rotor FA-45-16-17 aerosol-tight, angle 45°, 16 places, max. tube diameter 17 mm, incl. rotor lid (aluminum)
5427 751.009	5427751009	Rotor lid for FA-45-16-17 aerosol-tight, aluminum
5409 717.006	5409717006	Seal for rotor lid FA-45-24-11 (5427 R), FA-45-16-17 (5430/5430 R) 5 pieces

Rotor S-24-11-AT

Order no. (International)	Order no. (North America)	Description
5427 757.007	5427757007	Swing-bucket rotor S-24-11-AT aerosol-tight, steel, angle 90°, 24 places, max. tube diameter 11 mm, incl. rotor lid (aluminum)
5427 758.003	5427758003	Rotor lid for S-24-11-AT aerosol-tight, aluminum
5409 719.009	5409719009	Seal for rotor lid S-24-11-AT (5427 R/5430/5430 R) 5 pieces
5409 721.003	5409721003	Tube holder for S-24-11-AT for 4 × 1,5 mL/2,0 mL Eppendorf tubes set of 2 pieces

11.1.2 Rotors with threaded rotor lid

Rotor F-45-48-11

Order no. (International)	Order no. (North America)	Description
5427 755.004	5427755004	Rotor F-45-48-11 aluminum, angle 45°, 48 places, max. tube diameter 11 mm, incl. rotor lid (polypropylene)
5427 756.000	5427756000	Rotor lid for F-45-48-11 Polypropylene

Rotor FA-45-30-11

Order no. (International)	Order no. (North America)	Description
5427 719.008	022654063	Rotor lid for FA-45-30-11 aerosol-tight, PTFE-coated, aluminum

Rotor F-45-30-11

Order no. (International)	Order no. (North America)	Description
5427 712.003	022654004	Rotor F-45-30-11 PTFE-coated, angle 45°, 30 places, max. tube diameter 11 mm, incl. rotor lid (polypropylene)
5427 718.001	022654021	Rotor lid for F-45-30-11 Polypropylene

Rotor FA-45-24-11-HS

Order no. (International)	Order no. (North America)	Description
5427 710.000	022654080	Rotor FA-45-24-11-HS aerosol-tight, PTFE-coated, angle 45°, 24 places, max. tube diameter 11 mm, incl. rotor lid (aluminum), incl. rotor key
5427 711.007	022654101	Rotor lid for FA-45-24-11-HS aerosol-tight, PTFE-coated, aluminum

Rotor FA-45-24-11-Kit

Order no. (International)	Order no. (North America)	Description
5427 704.000	022654144	Rotor lid for FA-45-24-11-Kit aerosol-tight, aluminum

Rotor F-45-64-5-PCR

Order no. (International)	Order no. (North America)	Description
5427 714.006	022654209	Rotor F-45-64-5-PCR angle 45°, 64 places, max. tube diameter 5 mm, incl. rotor lid (aluminum) and adapters
5427 720.006	022654225	Rotor lid for F-45-64-5-PCR aluminum

Rotor F-45-18-17-Cryo

Order no. (International)	Order no. (North America)	Description
5427 705.007	022654161	Rotor F-45-18-17-Cryo angle 45°, 18 places, max. tube diameter 17 mm, incl. rotor lid (polypropylene) and adapters
5427 707.000	022654187	Rotor lid for F-45-18-17-Cryo Polypropylene

Rotor F-35-6-30

Order no. (International)	Order no. (North America)	Description
5427 716.009	022654306	Rotor F-35-6-30 angle 35°, 6 places, max. tube diameter 30 mm, incl. rotor lid (aluminum) and adapters for 15/50 mL conical tubes
5427 739.009	5427739009	angle 35°, 6 places, max. tube diameter 30 mm, incl. rotor lid
5427 715.002	022654322	Rotor lid for F-35-6-30 aluminum

11.1.3 Rotor with attached rotor lids

Rotor A-2-MTP

Order no. (International)	Order no. (North America)	Description
5427 700.005	022634403	Rotor A-2-MTP with 2 buckets and windshield upper shell
5427 722.009	022634420	MTP buckets for A-2-MTP Set of 2
5427 725.008	022654446	Wind shield upper shell for A-2-MTP aluminum

11.2 Accessories

11.2.1 Adapter

Order no. (International)	Order no. (North America)	Description
5425 715.005 5425 717.008 5425 716.001	022636260 022636243 022636227	Adapter used in FA-45-48-11, F-45-48-11, FA-45-30-11, F-45-30-11, FA-45-24-11-HS and FA-45-24-11-Kit for 1 PCR tube (0.2 mL, max. Ø 6 mm), set of 6 for 1 micro test tube (0.4 mL, max. Ø 6 mm), set of 6 for 1 sample tube (0.5 mL, max. Ø 6 mm) or 1 Microtainer (0.6 mL, max. Ø 8 mm), set of 6
5427 717.005	022654241	Adapter used in F-45-64-5-PCR for PCR strips, set of 4 pieces
5702 752.002 5427 708.006	022639498 5427708006	Adapter used in F-45-18-17-Cryo for cryo tubes (max. Ø 13 mm) and sealable centrifuge tubes (max. Ø 12.2 mm), max. length 50 mm, set of 6 for 1.5 mL HPLC vials, 18 pieces
5427 740.007 5427 741.003 5427 746.005 5427 726.004 5427 732.004 5427 735.003	5427740007 5427741003 5427746005 022654365 022654512 022654538	Adapter used in F-35-6-30, small tube bore 13 × 65-89, set of 2 13 × 90-110, set of 2 for Eppendorf Tubes 5.0 mL, set of 2 for 15 mL conical tubes, set of 2 for 7 - 15 mL round-bottom tubes and blood collection tubes, set of 2 for 9 - 15 mL round-bottom tubes and blood collection tubes, set of 2
5427 742.000 5427 743.006	5427742000 5427743006	Adapter used in F-35-6-30, large tube bore 13 × 65-89, set of 2 13 × 90-110, set of 2

Ordering Information
Centrifuge 5430/5430 R
English (EN)

Order no. (International)	Order no. (North America)	Description
5427 747.001	5427747001	for Eppendorf Tubes 5.0 mL, set of 2
5427 727.000	022654349	for 50 mL conical tubes, set of 2
5427 723.005	022654331	for Centriplus centrifugal filter units, set of 6
5427 734.007	022654524	for 7 - 15 mL round-bottom tubes and blood collection tubes, set of 2
5427 738.002	022654545	for 9 - 15 mL round-bottom tubes and blood collection tubes, set of 2
5427 736.000	022654556	for 20 - 30 mL round-bottom tubes, set of 2
5427 737.006	022654567	for 50 mL round-bottom tubes, set of 2
5825 711.009	022638947	Adapter used in A-2-MTP
5825 713.001	022638955	for 96-well PCR plates, set of 2
5825 706.005	022638963	for 384-well PCR plates, set of 2 CombiSlide Adapter, set of 2

11.2.2 Other accessories

Order no. (International)	Order no. (North America)	Description
5416 301.001	022634305	Rotor key Standard
5427 730.001	5427730001	for rotor FA-45-24-11-HS
5427 728.007	5427728007	Plate carrier for Rotor F-35-6-30
5810 350.050	022634330	Pivot grease Tube 20 mL
5428 850.418	022680452	Tray for condensation water

11.2.3 Fuses for Centrifuge 5430

Order no. (International)	Order no. (North America)	Description
5301 850.249	022654403	Fuse 4.0 A T (230 V), 2 pieces
5427 850.341	022654381	8.0 A T (120 V, 100 V), 2 pieces

Declaration of Conformity

The product named below fulfills the requirements of directives and standards listed. In the case of unauthorized modifications to the product or an unintended use this declaration becomes invalid. This declaration of conformity is issued under the sole responsibility of the manufacturer.

Product name:

Centrifuge 5430, Centrifuge 5430 R

including components

Product type:

Centrifuge

Relevant directives / standards:

2006/42/EC: DIN EN ISO 12100 + Cor.1, DIN EN 378-2 (only 5430 R)

2014/35/EU: DIN EN 61010-1, DIN EN 61010-2-020

2014/30/EU: DIN EN 61326-1, DIN EN 55011

2011/65/EU: DIN EN IEC 63000
(incl. (EU) 2015/863)

Further applied standards: IEC 61010-1 + Cor. + A1 + A1/Cor.1, IEC 61010-2-020
UL 61010-1, UL 61010-2-020
CAN/CSA C22.2 No. 61010-1-12, CAN/CSA C22.2 No. 61010-2-020
IEC 61326-1, CISPR 11 + A1, 47 CFR FCC part 15
YY/T 0657, GB 4793.1, GB 4793.7, GB 18268.1, YY/T 0466.1, SJ/T 11364,
GB/T 26572

Person authorized to compile

the technical file acc. to 2006/42/EC: Dr. Marlene Jentzsch
Senior Vice President
Division Separation & Instrumentation
Eppendorf SE

Hamburg, November 09, 2021



Dr. Wilhelm Plüster
Management Board



Dr. Marlene Jentzsch
Senior Vice President
Division Separation & Instrumentation

Your local distributor: www.eppendorf.com/contact
Eppendorf SE · Barkhausenweg 1 · 22339 Hamburg · Germany
eppendorf@eppendorf.com

Eppendorf® and the Eppendorf Brand Design are registered trademarks of Eppendorf SE, Germany.
All rights reserved, incl. graphics and pictures. Copyright ©2021 by Eppendorf SE.

ISO
9001
Certified

ISO 13485
Certified

ISO 14001
Certified

CERTIFICATE OF COMPLIANCE

Certificate Number 2018-2-9-E215059
Report Reference E215059-D1010-1/A0/C0-UL
Issue Date 2018-2-9

Issued to: Eppendorf AG
Applicant Company: Barkhausenweg 1
Hamburg, D-22339 Germany

Listed Company: Same as Applicant

This is to certify that representative samples of Laboratory centrifuge
5430R (5428)

Have been investigated by UL in accordance with the Standard(s) indicated on this Certificate.

Standard(s) for Safety: UL 61010-1, 3rd Edition, May 11, 2012, Revised July 15 2015, CAN/CSA-C22.2 No. 61010-1-12, 3rd Edition, Revision dated July 2015

Additional Standards: IEC 61010-1 - Edition 3 - Revision Date 2013/02/01
IEC 61010-2-020 - Edition 3 - Issue Date 2016/05/01
UL 61010-2-020 - Edition 3 - Issue Date 2016/12/15
CSA C22.2 NO. 61010-2-020 - Edition 3 - Issue Date 2017/05/01

Additional Information: See the UL Online Certifications Directory at www.ul.com/database for additional information.

Only those products bearing the UL Certification Mark should be considered as being covered by UL's Certification and Follow-Up Service.

Look for the UL Certification Mark on the product.

This is to certify that representative samples of the product as specified on this certificate were tested according to the current UL requirements.

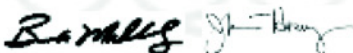

Bruce Mahrenholz, Assistant Chief Engineer, Global Inspection and Field Services, UL LLC
Joseph Hosey, General Manager, Director of Sales – Canada, UNDERWRITERS LABORATORIES OF CANADA INC.

Any information and documentation involving UL Mark services are provided on behalf of UL LLC (UL) or any authorized licensee of UL. For questions, please contact a local UL Customer Service Representative www.ul.com/contactus





Certificate of Containment Testing

**Rotor FA 45-30-11 (5427 713.107-00)
with sealed lid in Eppendorf centrifuge
5430**

Report No. 955-05

Report prepared for: Eppendorf AG, Hamburg, Germany
Issue Date: 2nd June 2005

Test Summary

The FA 45-30-11 rotor (5427 713.107-00) was containment tested in the Eppendorf centrifuge 5430, using Annex AA of IEC 1010-2-20. The rotor was shown to contain a large spill within the rotor.

Report Written By

A blue ink signature written over a dashed horizontal line.

Report Authorised By

A blue ink signature written over a dashed horizontal line.

Centre of Emergency Preparedness and Response
Health Protection Agency
Porton Down
Salisbury
Wiltshire SP4 0JG
United Kingdom

Certificate of Containment Testing

**Rotor FA 45-24-11-HS
(5427 710.108-01) with sealed lid in
Eppendorf centrifuge 5430**

Report No. 980-05 B

Report prepared for: Eppendorf AG, Hamburg, Germany
Issue Date: 8th November 2005

Test Summary

The FA 45-24-11-HS rotor (5427 710.108-01) was containment tested in the Eppendorf centrifuge 5430, using Annex AA of IEC 1010-2-20. The rotor was shown to contain a large spill within the rotor.

Report Written By

A blue ink signature written over a horizontal dashed line.

Report Authorised By

Two blue ink signatures written over a horizontal dashed line.



Certificate of Containment Testing

**Rotor FA 45-24-11-KIT (5427 703.101-00)
with sealed lid in Eppendorf centrifuge
5430**

Report No. 956-05

Report prepared for: Eppendorf AG, Hamburg, Germany
Issue Date: 7th June 2005

Test Summary

The FA 45-24-11-KIT rotor (5427 703.101-00) was containment tested in the Eppendorf centrifuge 5430, using Annex AA of IEC 1010-2-20. The rotor was shown to contain a large spill within the rotor.

Report Written By

A blue ink signature written over a horizontal dashed line.

Report Authorised By

A black ink signature written over a horizontal dashed line.



Certificate of Containment Testing

Containment Testing of Rotor FA-45-30-11 (5427 753.109-00) in the Eppendorf 5430/R Bench Top Centrifuge



Report No. 201-12 B

Report Prepared For: Eppendorf AG, Hamburg, Germany

Issue Date: 12th September 2012

Test Summary

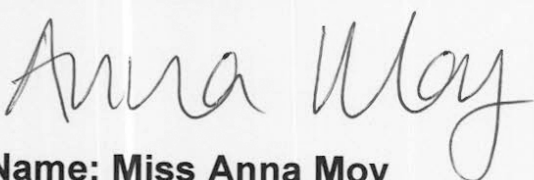
Rotor FA-45-30-11 (5427 753.109-00) was containment tested in the Eppendorf 5430/R bench top centrifuge, using Annex AA of IEC 1010-2-20. The sealed rotor was shown to contain a spill within the centrifuge

Report Written By  Name: Miss Anna Moy Title: Biosafety Scientist	Report Authorised By  Name: Mrs Sara Speight Title: Senior Biosafety Scientist
--	--



Certificate of Containment Testing

Containment Testing of Rotor FA-45-48-11 (5427 754.105-00) in the Eppendorf 5430/R Bench Top Centrifuge



Report No. 201-12 A

Report Prepared For: Eppendorf AG, Hamburg, Germany

Issue Date: 12th September 2012

Test Summary

Rotor FA-45-48-11 (5427 754.105-00) was containment tested in the Eppendorf 5430/R bench top centrifuge, using Annex AA of IEC 1010-2-20. The sealed rotor was shown to contain a spill within the centrifuge

Report Written By  Name: Miss Anna Moy Title: Biosafety Scientist	Report Authorised By  Name: Mrs Sara Speight Title: Senior Biosafety Scientist
--	--



Certificate of Containment Testing

Containment Testing of Rotor FA-45-24-11-Kit (5427 752.102-00) in the Eppendorf 5430/R Bench Top Centrifuge

Report No. 201-12 D

Report Prepared For: Eppendorf AG, Hamburg, Germany

Issue Date: 12th September 2012

Test Summary

Rotor FA-45-24-11-Kit (5427 752.102-00) was containment tested in the Eppendorf 5430/R bench top centrifuge, using Annex AA of IEC 1010-2-20. The sealed rotor was shown to contain a spill within the centrifuge

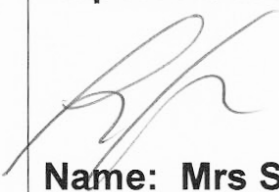
Report Written By  Name: Miss Anna Moy Title: Biosafety Scientist	Report Authorised By  Name: Mrs Sara Speight Title: Senior Biosafety Scientist
--	--



Certificate of Containment Testing

Containment Testing of Rotor FA-45-16-17 (5427 750.100-00) in the Eppendorf 5430/R Bench Top Centrifuge

Report No. 39/13

Report Prepared For: Eppendorf AG, Hamburg, Germany

Issue Date: 24th April 2013

Test Summary

Rotor FA-45-16-17 (5427 750.100-00) was containment tested in the Eppendorf 5430/R bench top centrifuge, using Annex AA of IEC 61010-2-020:2006 (2nd Ed.). The sealed rotor was shown to contain a spill within the centrifuge.

Report Written By

Name: Miss Anna Moy

Title: Biosafety Scientist

Report Authorised By

Name: Mrs Sara Speight

Title: Senior Biosafety Scientist



Certificate of Containment Testing



Containment Testing of Rotor S-24-11-AT (5427 757.104-00) in the Eppendorf 5430/R Bench Top Centrifuge

Report No. 201-12 E

Report Prepared For: Eppendorf AG, Hamburg, Germany
Issue Date: 12th September 2012

Test Summary

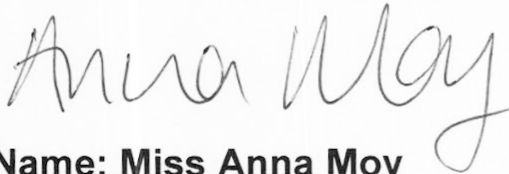
Rotor S-24-11-AT (5427 757.104-00) was containment tested in the Eppendorf 5430/R bench top centrifuge, using Annex AA of IEC 1010-2-20. The sealed rotor was shown to contain a spill within the centrifuge

Report Written By  Name: Miss Anna Moy Title: Biosafety Scientist	Report Authorised By  Name: Mrs Sara Speight Title: Senior Biosafety Scientist
--	--

Evaluate Your Manual

Give us your feedback.

www.eppendorf.com/manualfeedback

Your local distributor: www.eppendorf.com/contact

Eppendorf SE · Barkhausenweg 1 · 22339 Hamburg · Germany
eppendorf@eppendorf.com · www.eppendorf.com