



# FREEZER OWNERS' MANUAL

BLOOD BANK

## Document History

Revision	Date	Change Initiator (s)	Revision Description
1	Nov 2021	T. Bostic	Initial release: HS-MAT-LBL-0006
2	Dec 2021	T. Bostic	Minor content and formatting changes. CR-2021-0067.

## Updates to this Document

This document is provided for informational purposes only and is subject to change without notice and is not a guarantee of commitment by COREPOINT Scientific™ or Horizon Scientific, Inc., a Standex International Corporation business. Horizon Scientific, Inc., assumes no responsibility or liability for any errors or inaccuracies that may appear in the content within this document. The most recent revision is considered to be up to date and valid.

## Confidential/Proprietary Notices

The use of the content of this document, in part or in whole is expressly prohibited. CORPOINT Scientific™, is a registered trademarks or trademarks of Horizon Scientific, Inc., a Standex International Corporation business in the United States of America. All other trademarks and registered trademarks are the property of their respective owners. Horizon Scientific, Inc., doing business as (DBA) Horizon Scientific and Horizon.

## Disclaimer

This manual is intended as a resource to provide the operator with instructions on the proper use and maintenance of particular COREPOINT Scientific™ and of Horizon Scientific, Inc. products.

Failure to adhere to the instructions as herein could result in improper product operation, injury, and potentially void product warranties. COREPOINT Scientific™ and of Horizon Scientific, Inc. accepts no liability or responsibility for results stemming from improper use or maintenance of its products.

The content within this guide is provided for illustrative purposes only and may vary from the actual hardware or software photos, screen shots or illustrations.

Horizon Scientific, Inc.  
125 Varnfield Drive  
Summerville, SC 29483

[www.horizonscientific.com](http://www.horizonscientific.com)

# TABLE OF CONTENTS

- 1. GENERAL ..... 4**
  - 1.1 INTENDED AUDIENCE ..... 4
  - 1.2 INTENDED USE ..... 4
  - 1.3 SAFETY AND NOTICES ..... 4
- 2. INSTALLATION ..... 8**
  - 2.1 UNPACKING ..... 8
  - 2.2 GENERAL RECOMMENDATIONS..... 8
  - 2.3 LOCATION AND FUNCTIONAL INSPECTION ..... 8
  - 2.4 LEVELING AND ANCHOR INSTALLATION (*Anchors are optional accessories*)..... 10
  - 2.5 DOOR ALIGNMENT ..... 11
  - 2.6 DRAWERS..... 12
  - 2.7 ELECTRICAL COMPONENTS..... 13
  - 2.8 ELECTRICAL INSTALLATION ..... 13
  - 2.9 CHART RECORDER (*If included*) ..... 14
  - 2.10 TEMPERATURE PROBES ..... 14
  - 2.11 EXTERNAL PROBE ACCESS PORT ..... 15
  - 2.12 BATTERY BACKUP..... 16
  - 2.13 INITIAL POWER UP AND OPERATION ..... 16
- 3. CONTROLLER ..... 17**
  - 3.1 CONTROLLER OVERVIEW ..... 17
  - 3.2 OPERATING THE CONTROLLER ..... 18
- 4. PRODUCT SPECIFICATIONS..... 28**
  - 4.1 OPERATING STANDARDS ..... 28
- 5. MAINTENANCE ..... 29**
  - 5.1 INSPECTION AND SERVICING ..... 29
  - 5.2 SERVICE AND ANALYSIS GUIDE ..... 31
- 6. WARRANTY ..... 32**
  - 6.1 FACTORY WARRANTY ..... 32
  - 6.2 COMPRESSOR WARRANTY..... 32
  - 6.3 ADDITIONAL WARRANTY INFORMATION ..... 32
  - 6.4 WARRANTY CLAIMS..... 33
- 7. COMPLIANCE ..... 34**
  - 7.1 APPLICATION..... 35
  - 7.2 SAFETY ..... 35
  - 7.3 ENVIRONMENTAL ..... 35

---

# 1. GENERAL

## 1.1 INTENDED AUDIENCE

This manual is intended for authorized service technicians and end users. The information herein pertains only to the specifically indicated products.

## 1.2 INTENDED USE

This unit is intended for medical and laboratory use including the storage of Blood Products as defined and regulated by the FDA and is a listed Class II medical device, 21CFR part 820 compliant.

## 1.3 SAFETY AND NOTICES

### Symbols found in this manual



This is a general warning, caution, hazard, or important consideration symbol.



This is an electrical hazard caution / warning symbol.



This is a hot surface hazard caution / warning symbol.



This is a flammable hazard caution / warning symbol.



This is a pinch or potential injury hazard caution / warning symbol.

### Warnings, cautions, and important considerations





**WARNING:** This product can expose you to chemicals including chromium which is known to the State of California to cause cancer and birth defects or other reproductive harm. For more information, go to [www.P65Warnings.ca.gov](http://www.P65Warnings.ca.gov)





**WARNING:** Electric Shock Hazard. Do Not Remove top electrical cover. Contact a qualified service representative.

 **WARNING:** Do not remove electrical system components access unless instructed to do so.

 **WARNING:** Do not modify, change, damage, refrigeration circuit or electrical components, unless work is performed by a certified technician.

 **WARNING:** Only use manufacturing supplied power cord, never use an extension cord.

 **WARNING:** The controller automatically switches power to devices such as the light circuit, perimeter heaters, or evaporator fans. Always unplug before making repairs.

 **WARNING:** Never open / extend multiple drawers at the same time.

 **WARNING:** Do not overload drawers or shelves with heavy products or concentrated loads, this increases likelihood of items falling and causing injury.

 **WARNING:** Do not store any unsealed chemical material in this cabinet. Corrosive fumes from chemical material can linger inside of the chamber and cause serious damage to the refrigeration coils. Storing unsealed chemical material in this equipment will void the factory product warranty.

 **WARNING:** Do not store or use gasoline, or other flammable liquid in this cabinet. This equipment is not rated to be a flammable material storage.

 **WARNING:** Do not operate this equipment in the presence of explosive fumes.

 **WARNING:** This equipment is not rated as a hazardous locations storage cabinet.

 **CAUTION:** Before moving the unit, make sure the door is closed, casters are unlocked and free of obstructions, and disconnect the power cord (make sure cord is secured).

 **CAUTION:** Do not touch the hot surfaces associated with the condenser system.

 **CAUTION:** Do not use any devices to accelerate the defrosting process.

 **CAUTION:** Avoid any sharp edges or points when working on or in the unit.

 **CAUTION:** Keep fingers out of pinch point areas; clearances between the doors and between the doors and cabinet are necessarily small; be careful closing doors.



**CAUTION:** While cleaning condenser coil, care should be taken when lifting the canopy to prevent the canopy from falling.



**IMPORTANT:** Only use manufacturer supplied or approved components and authorized personnel, when servicing the unit.



**IMPORTANT:** This unit must be properly installed and located in accordance with the Installation Instructions before it is used.



**IMPORTANT:** This unit must be decontaminated prior to sending for repair or service. Contact Horizon Scientific or your distributor for decontamination instructions.

### **Specific to hydrocarbon refrigerants only:**



**DANGER:** Risk of fire or explosion, flammable refrigerant used. Do not use mechanical devices to defrost the unit. Do not puncture refrigerant tubing.

- **DANGER:** Risk of fire or explosion, flammable refrigerant used. To be repaired only by trained service personnel. Do not puncture refrigerant tubing.
- **CAUTION:** Risk of fire or explosion, flammable refrigerant used. Consult repair manual/owner's guide before attempting to service this product. All safety precautions must be followed.
- **CAUTION:** Risk of fire or explosion, flammable refrigerant used. Dispose of properly in accordance with federal or local regulations.
- **CAUTION:** Risk of fire or explosion, flammable refrigerant used. Do not puncture of refrigerant tubing; follow handling instructions carefully.
- **Environment:** Proper ventilation must be provided, and all ventilation openings kept free of obstruction

## 1.4 RECEIVING AND SHIPPING DAMAGE HANDLING

Each unit is carefully inspected to meet our high standard quality assurance policy before it ships to you. Unfortunately, shipping damage can happen during transportation to you. There are two general types of shipping damage. The first is visible damage. This type of damage includes visible loss, damage, shortage or any external evidence of loss or damage that is visible at time of delivery. This type of damage must be noted in detail on your delivery receipt. Make sure the driver signs and dates the delivery receipt, acknowledging the damages. We also recommend taking many pictures to demonstrate and document the damaged area(s). This must happen at the time of delivery. Keep a copy for your records and send another to the carrier's damage claims department along with a formal request for an inspection report. Follow up with a phone call. Their contact information can be found on the carrier's web site.

The second type of shipping damage is concealed damage. This type of damage will probably not be apparent at time of delivery and may not be discovered until unpacking and inspecting the unit. Remember, time is of the essence. You should unpack and inspect the unit as soon as possible. Each day that passes reduces the likelihood that the carrier will pay the claim. As soon as the concealed damage is discovered, stop unpacking and retain all packing materials. Take many pictures to demonstrate and document the concealed damage area(s). Contact the carrier by phone to report the claim. Note the date and time and person you spoke with. Get a claim number. Follow up with a written letter referencing the claim number and including a formal request for an inspection. Again, consult the carrier's website for specific claim instructions and follow them precisely.



**AS STATED ABOVE, THE CARRIER IS YOUR SOLE SOURCE FOR SATISFACTION OF A DAMAGE CLAIM. UNDER NO CIRCUMSTANCES SHOULD THE MERCHANDISE BE RETURNED TO THE MANUFACTURER. NO RETURNS WILL BE ACCEPTED WITHOUT PRIOR AUTHORIZATION.**

## 2. INSTALLATION

### 2.1 UNPACKING

- A fork truck or pallet jack is required to remove the unit from the pallet. Remove packaging for unobstructed access under the unit.
- When using a fork truck, place forks under the unit from the front or rear of the unit. Forks should be set as wide as possible for stability. DO NOT place forks in the center of the unit to avoid tip over.
- When using a pallet jack, align forks directly in front or back of the unit, making sure to avoid the casters. Lift forks to the same height as the top runners supporting the unit. Slide unit straight forward or backward until casters are free from the skid, then lower unit to the floor.

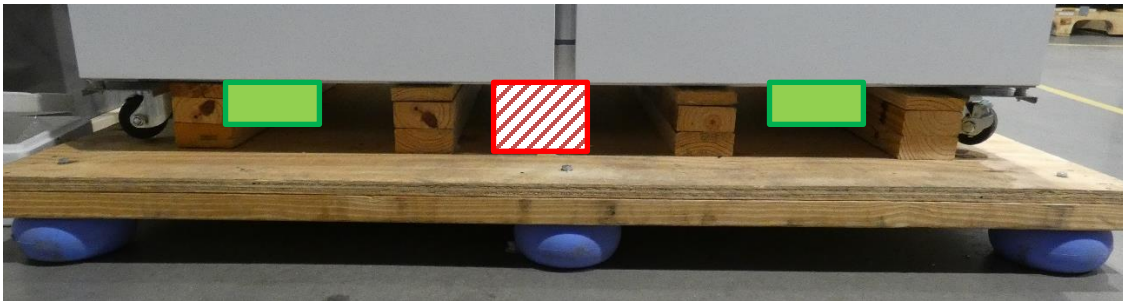

**Pallet and Fork Positions**

Remove foam/cardboard shipping supports from the inside of the chamber prior to powering on unit. Make sure to do this after the unit is set in place to prevent damage.

### 2.2 GENERAL RECOMMENDATIONS

- Allow the unit to come to room temperature before starting. The high temperature alarm will sound until the unit is able to bring the internal temperature down from initial start-up.
- Allow for the set point to be reached and for the unit to stabilize before storing products.
- Do not overload the unit.
- Only store items within drawers or baskets. Products stacked against walls or doors may obstruct air flow and impair the performance of unit.

### 2.3 LOCATION AND FUNCTIONAL INSPECTION

Ambient conditions: Unlike a household unit, this equipment is designed for scientific and medical applications. Many components are heavy duty and optimized to meet demanding temperature performance requirements. Therefore, the sounds generated from its operation may not be accepted by everyone in the room. Please take the operation sound factor into consideration and locate the unit accordingly.



Please ensure the ambient temperature is typically climate-controlled, +18°C to +26°C (+65°F to +78°F), <70% RH, to ensure efficiency and strong thermal performances. Some ambient state excursions are acceptable, but performance may be impacted if used in other environmental conditions. Please refer to the Product Specifications section of this manual for guidance.

Clearance Space: This model requires a minimum of 2 clearance space around the unit. This will allow good airflow and access to the unit for periodic maintenance, or service.

The cabinet must be located within reach of an outlet that has appropriate power supply as listed above with a protective earth ground. The outlet should be easily accessible when installation is complete as this is the only method for powering off the equipment.



Do not stack items on top of the unit. This can damage sheet metal components and block airflow, compromising performance.

## 2.4 LEVELING AND ANCHOR INSTALLATION (Anchors are optional accessories)

### Leveling

Ensure that the placement chosen for installation has a level floor. The unit must be level side to side and front to back. If the unit is not level, corrections can be made using hard and durable shim stock (hard plastic or corrosion resistant metal sheets) under the casters. Ensure that the caster locks are engaged.



If the unit is not level, automated door closure and drawer operation may be negatively impacted.

### Anchor Brackets (optional)



It is highly recommended that the system is anchored in some manner to resist tip over. Since different installations have different requirements, the optional anchor system may not meet your requirements.



Anchor brackets provide tip over resistance only. This is not a seismic rated system. Application performance is not warranted since the installation is not controlled by Horizon Scientific, Inc.

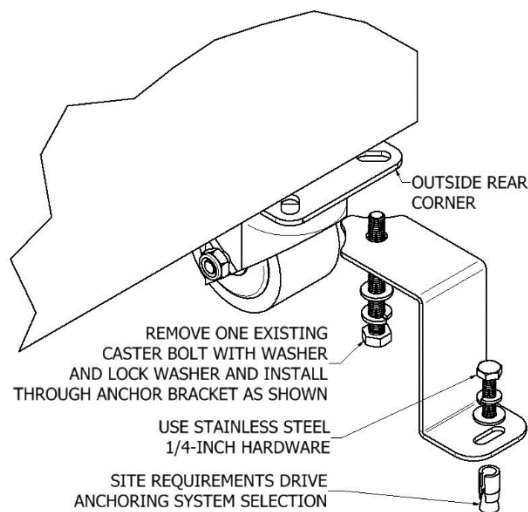

### Anchor Bracket Installation

Anchor brackets are attached to the unit using the exterior, rear caster bolts. One anchor bracket is required for each rear caster. The following process is suggested but on-site conditions may require adaptation. Only qualified technicians should perform this operation.

The anchor bolt and type must be selected and installed by a qualified, on-site technician. It is recommended that ¼" diameter stainless steel bolts and washers be used for installation to prevent corrosion. The anchor bracket provides flexibility to accommodate most floors, but shims can be used if necessary.

1. On each of the rear casters, remove the rear most, outboard bolt. Be careful to retain the washers.
2. Position an anchor bracket on each side and reuse the removed bolts to attach the bracket. Firmly tighten the bolts.
3. Position the unit exactly as it is to be installed in the facility.
4. Mark the slot position on the floor for each side once the installation position is finalized.
5. Drill and install floor anchor hardware as appropriate on one anchor bracket without fully tightening the floor anchor bolt.
6. Verify the position of the remaining slot is still properly aligned.
7. Drill and install the second set of floor anchor hardware and anchor bracket.
8. Firmly tighten both anchor bolts.

## **2.5 DOOR ALIGNMENT**

Verify that each door is level and opens and closes easily. If adjustment is needed, the bolts for the top hinge bracket may be loosened and moved by a qualified technician to properly align the door.

## 2.6 DRAWERS

### Product Storage Setup

The cabinet comes standard with repositionable and removable stainless-steel drawers supported by high capacity sliding rails. Pilasters are factory installed and allow user to select spacing between each drawer. Drawers are rated to 65 lbs. (29.5 kg) each.



Drawers are designed for a precision fit; it is critical that they are properly installed and locked securely into position.



**CAUTION:** The drawers and drawer hardware present pinch points when assembling and disassembling.

### Drawer Installation and Repositioning

1. Position support bracket with both hooks inserted completely into the front and back pilaster strips at the same height (level horizontally).
2. Engage white locking levers at front and back of bracket, making sure bracket is properly secured to both pilasters.
3. Repeat steps 1-2 for opposing support bracket, making sure brackets are at same height on left and right to support both sides of the tray.
4. To remove and replace drawers:
  - i. Depress locking tabs on drawer sides (alternatively, the integral slide locks can be used to remove the inner slide race while it stays attached to the drawer)
  - ii. Pull up front of drawer out of vertical tabs
  - iii. Slide drawer forward out of horizontal tabs
  - iv. To replace drawer, reverse the process and reset locking tabs when installed



**Drawer Bracket Lever Lock**



**Drawer Removal**

## 2.7 ELECTRICAL COMPONENTS

### Remote Alarms Contacts

The remote alarm contacts terminal block is located at the back of the cabinet as shown. Terminals are labeled NC (normally closed), COM (Common), and NO (normally open). Terminal connections are rated per the included specification table. End user is responsible for proper field installation.

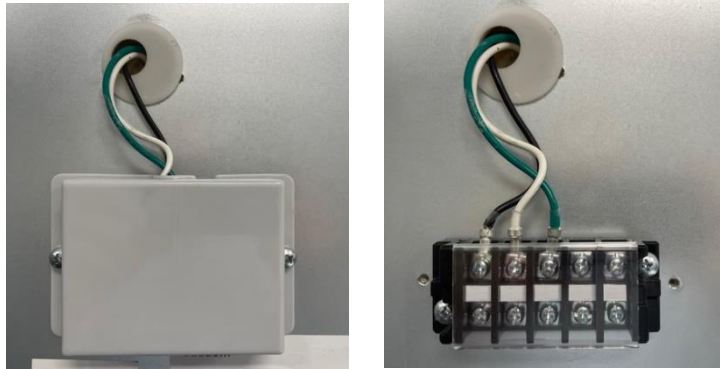

**Remote Alarm Contact (RAC) Terminal Block: Black and White – Normally Closed, Green and White – Normally Open**

### RS485 terminals

The RS485 terminals are located on the top of the unit. Connect wires to the -Tx/Rx, +Tx/Rx, and GND terminals per the label.

## 2.8 ELECTRICAL INSTALLATION

Check the proposed external power outlet/supply to be used to ensure that the voltage, phase and current carrying capacity of the circuit from the electrical panel correspond to the requirements of the cabinet.



The supply circuit to this cabinet must conform to NEC (National Electrical Code). Consult the cabinet Serial-Data plate for voltage, cycle, phase, and amperage requirements before making connection.



Supply voltage should not vary more than 10% from the serial plate ratings



DO NOT connect this equipment to a GFI (Ground Fault Interrupt) circuit.



**Do not use an extension cord or any multi-outlet strip or plug.** Using such devices can lead to insufficient power and component failure, such as the compressor or starting components.



If the power cord is damaged, it should be replaced immediately by an authorized service technician.



Be sure your unit is properly grounded. Use the 3-prong plug provided into a 3-prong grounded outlet. Unless the above grounding method is followed, you are not protected against severe or lethal shock in the event of a short circuit of an electrical component or wiring of the unit.

## 2.9 CHART RECORDER (If included)



Caution: Do not lift the pen arm in order to install or remove chart paper. This will bend the pen arm and may prevent the arm from providing enough pressure to draw a legible mark. Ensure that the current time and day is aligned with the line groove when it is installed.

### Chart recorder operation and paper replacement

1. Press and hold (#3) button approximately 1 second. When pen arm moves, release button. The LED will flash.
2. When the pen arm stops moving (off the paper), unscrew and remove the chart knob from the center of the paper.
3. Place chart paper on the recorder.
4. Rotate the paper so the correct time is aligned with the time-line groove.
5. Make sure to hold chart paper in place while securing chart knob is fully tightened. (NOTE: only hand tighten chart knob. Over tightening can damage the chart motor gearbox).
6. Press and hold (#3) button approximately 1 second until pen arm begins moving. Make sure it is writing on the paper, if not may need to be adjusted to properly contact the paper. Also make sure it stops at the correct temperature.
7. Calibrate the recorder to match the temperature if needed and close the chart recorder door.

### Chart recorder power supply

The chart recorder uses AC power during normal operation. If power fails, the recorder continues to record the temperature with the supplied 9V battery back-up. The light on the chart recorder indicates the power status:

- LED indicator shows green continually when main power is functioning, and the battery is charged.
- LED indicator shows flashes green to indicate that either the main power has failed, and the recorder is receiving power only from the battery back-up, or the main power is on and the battery needs to be replaced.
- LED indicator flashes during the chart paper changing mode.

## 2.10 TEMPERATURE PROBES

A primary temperature monitoring probe (a bottle containing a glycerol mixture or a thermally equivalent a solid ballast) has been provided with the unit. This probe is located on the right side, near the top of the cabinet interior. The glycerol or solid ballasts are designed to simulate the temperature of stored product during normal operation. Failure to maintain a full probe bottle may cause the display to report temperatures that do not represent the stored product temperature accurately.

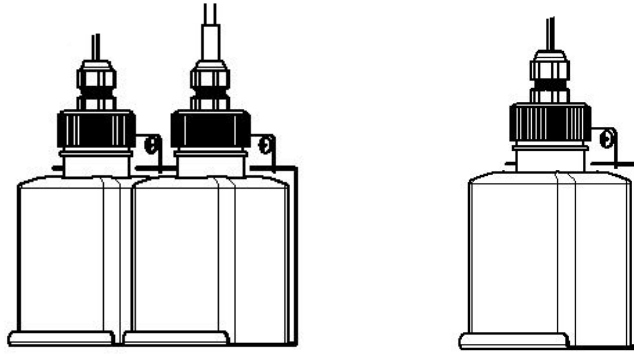

**Liquid Thermal Ballast Configurations**

A secondary temperature monitoring probe (solid ballast) has also been provided with the unit. This probe is located on the right side, near the bottom of the cabinet interior.

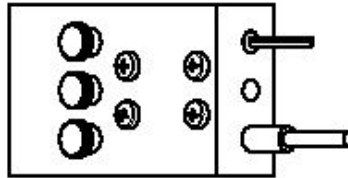

**Solid Thermal Ballast**

## **2.11 EXTERNAL PROBE ACCESS PORT**

This unit is equipped with a  $\frac{3}{4}$ " (19 mm) port that can be used for external monitoring devices. This port is located on the back of the unit. Remove the rubber plug in the port for routing.



**Probe Access Port on Rear of Unit**

## **2.12 BATTERY BACKUP**

The controller comes standard with a battery backup feature that allows the controller to maintain temperature monitoring and alarms even if the main power is lost.

To activate the battery backup, insert the 5A glass fuse into the battery fuse holder at the top of the unit and secure the thumbscrew cap. This fuse is shipped loose so the batteries are not discharged during transport or storage.

NOTE: The unit cannot cool without main power, but the controller will continue to display and log alarms until the battery backup is discharged.

Note: A low battery voltage alarm may sound after powering on the unit. The alarm may be muted, and it may be necessary for the batteries to charge properly up to 1 hour before the alarm can be cleared.

## **2.13 INITIAL POWER UP AND OPERATION**

Once all elements of the installation and any on site IQ (Installation Qualification) have been completed, your unit is ready for startup. Simply plug in the unit into a grounded outlet that meets the electrical requirements, and the unit will automatically begin the startup sequence.

These units employ an advanced PID, programmable controller to modulate the temperature within the cabinet. The controller, which is located on the canopy of the unit, is factory set.

Each time power is applied to the unit, the controller records a “power loss alarm” condition to document each time the controller is powered on. This alarm can be cleared immediately as it does not impact the function of the unit. Refer to the next section for details on the operation of the controller.



## 3. CONTROLLER

### 3.1 CONTROLLER OVERVIEW



**Important:** The graphics within this manual are for illustration only and do not indicate expected performance, parameter settings, or system response. Some settings, features, or functions described in this section may not apply to your model.



Panel front view

#### Key functions



**ALARM KEY:** Displays active alarms, alarm history, acknowledge alarms, and clear alarms. Back lit when an alarm is active.



**PROGRAM KEY:** Allows access to set points and main control parameters.



**ESCAPE KEY:** Returns to the main menu (SYSTEM STATUS).



**DOWN KEY:** Decreases parameter values and scrolls through screens.



**ENTER KEY:** Moves the cursor between parameter fields and confirms the set data.



**UP KEY:** Increases parameter values and scrolls through screens.

## 3.2 OPERATING THE CONTROLLER



Initial screen: Displays software version temporarily during initialization. After initialization, Press  ENTER key from the System Status screen to display.

KEY:  ESCAPE

Pressing the  Escape key will display the following screen. The SYSTEM STATUS screens are display only. To change set points, use the Setup Menu. To view the other SYSTEM STATUS screens, press the UP or Down Arrow keys.

Note: The main system status screen will change in appearance depending on what options are enabled in the control. The following three screens show what the main system status screen will look like with different options.

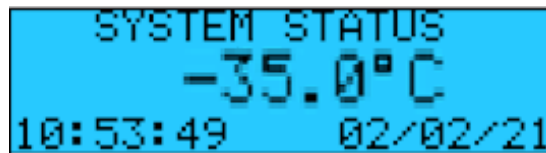

This screen displays the product temperature and the current date and time.



This screen displays the product temperature probe and the reading from the control probe



This screen displays the status of the refrigeration system, the number of door openings and the status of the backup battery.



```
SYSTEM STATUS 4
COMP RUN:      0hrs
FAN RUN:       0hrs
DEFROST RUN:   0hrs
```

This screen displays the run hours of critical components of the refrigeration system

KEY:  PROGRAM



Pressing the  Program key will display the following screen.



```
SETUP MENU
SETPOINTS  >
PARAMETERS >
SENSOR TEST >
```

This screen allows access to the listed set up screens. Press the  Enter to move the cursor to the desired field and press the Up or Down Arrow key to select the screens of each group.

Note: For all screens that allow values or parameters to be changed, navigation will follow this sequence:



Press the  Enter key to move the cursor between data fields that may be set by the user. Use the Up or Down Arrow key to increase or decrease the value of the selected data field. When the correct value or selection is displayed press the  Enter key to confirm the selection, which moves the cursor will to the next field. When the cursor is in the upper left-hand corner, press the Up or Down Arrow key to scroll through the other screens within the menu or press the  Escape key to return to the System Status screen.

### Set points

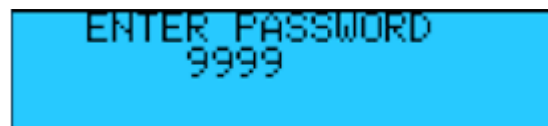
Note: If password protection is used, the following screen will be displayed before allowing access to the SET POINTS screens. On initial start-up there is no password protection. The passwords are set in the PARAMETERS group. If no password protection is used the “ENTER PASSWORD” screen will not be displayed.



```
ENTER PASSWORD
9999
```

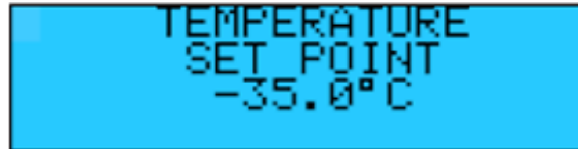

Press the  Enter key to move the cursor to the four-digit password. Use the Up or Down Arrow key to increase or decrease the number. When the correct password is displayed press the  Enter key to enter the password. If the correct password was entered the corresponding Set Points screen will be displayed. If a wrong password was entered “WRONG PASSWORD” will be displayed on the bottom line. The password can be re-entered or press the  Escape key to return to the System Status screen.

## SET POINTS: Screen 1



```
TEMPERATURE
SET POINT
-35.0°C
```

Factory Default Setting: -35.0°C

Press the  Enter key to move the cursor to the setpoint field. Use the Up or Down arrow key to increment the setpoint. Press the  Enter key to move the cursor back to upper left-hand corner

## SET POINTS: Screen 2



```
AIR TEMP ALARM
HIGH ALARM> -10.0°C
LOW ALARM> -50.0°C
ALARM DELAY>120 sec
```

Factory Default Setting: High Alarm -10.0°C

Factory Default Setting: Low Alarm -50.0°C

Factory Default Setting: Alarm Delay 120 Sec

Note: The High and Low Air Temperature Alarms provide an early warning prior to the product temperature alarm. They should be set to allow the normal rise and fall of the air temperature during normal operation. High ambient temperature and heavy door use may require a longer Alarm Delay. The ALARM DELAY is the amount of time in seconds that the temperature must be above or below the alarm set point for the alarm to activate.

## SET POINTS: Screen 3



```
PROD TEMP ALARM
HIGH ALARM> -20.0°C
LOW ALARM> -50.0°C
ALARM DELAY> 0 sec
```

Factory Default Setting: High Alarm -20.0°C

Factory Default Setting: Low Alarm -50.0°C

Factory Default Setting: Alarm Delay 0 Sec

Note: The ALARM DELAY is the amount of time in seconds that the temperature must be above or below the alarm set point for the alarm to activate.

There will be separate product temperature alarm screens for both upper product and lower product probes.

#### SET POINTS: Screen 4

```
LOWER TEMP ALARM  
HIGH ALARM> -20.0°C  
LOW ALARM> -50.0°C  
ALARM DELAY> 0 sec
```

#### SET POINTS: Screen 5

```
DEFROST> DISABLED  
FORCE DEFROST> OFF  
MAX. DF TIME> 36 min  
MIN. DF TEMP> 2.0°C
```



Caution do not change defrost settings. Ice buildup will impact the freezers' ability to maintain temperature. Defrost settings should not be altered by a user or a technician without first consulting technical service.

#### SET POINTS: Screen 6

```
DEFROST SCHEDULE  
  
DF1>00:00 DF4>18:00  
DF2>06:00 DF5>23:59  
DF3>12:00 DF6>23:59
```

#### SET POINTS: Screen 7

```
DELAY SETUP  
STARTUP> 2 sec  
FAN> 60 sec
```

This screen allows the user to edit the system startup delay and the fan delay.

STARTUP: Time, in seconds, after controller initializes before compressor starts

FAN: Time after defrost before evaporator fan restarts. Does not apply to refrigerators.



Force Defrost: Use this setting to manually initiate a defrost cycle that will terminate automatically per the user defined settings

## PARAMETERS:

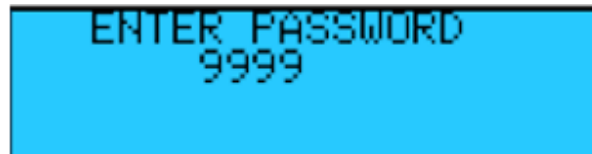
Note: If the password protection is used the following screen will be displayed before allowing access to the PARAMETERS screens. On initial start-up there is no password protection. The passwords are set in the PARAMETERS group. If no password protection is used the "ENTER PASSWORD" screen will not be displayed.



```
ENTER PASSWORD
9999
```

Press the  Enter key to move the cursor to the four-digit password. Use the Up or Down Arrow key to increase or decrease the number. When the correct password is displayed press the  Enter key to enter the password. If the correct password was entered the corresponding screen will be displayed. If a wrong password was entered "WRONG PASSWORD" will be displayed on the bottom line. The password can be re-entered or press the  Escape key to return to the System Status screen.

## PARAMETERS: Screen 1

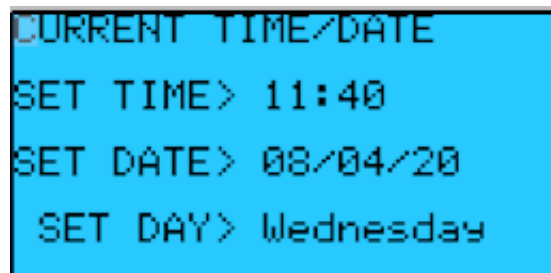

```
CURRENT TIME/DATE
SET TIME> 11:40
SET DATE> 08/04/20
SET DAY> Wednesday
```

Note: This setting allows the user to edit the real-time clock. The system will reference the real-time clock for scheduling and alarm logging purposes.

## PARAMETERS: Screen 2



```
DOOR AJAR ALARM
ENABLE
DELAY > 0 min
```

Factory Default Setting: Door Ajar Alarm Enable

Factory Default Setting: Delay 1 min

Note: This setting allows the user to enable or disable the door ajar alarm feature and set the delay in minutes.

### PARAMETERS: Screen 3

```
PRODUCT LOWER  
ENABLE  
DISPLAY PROD UPPER
```

Factory Default Setting: ENABLE lower Product probe

Factory Default Setting: display upper product probe

Note: This setting allows the user to enable or disable an optional secondary product probe. This screen also allows the user to select the probe displayed on the system status screen between the upper and lower product temperatures.

### PARAMETERS: Screen 4

```
AUDIBLE ALARM SETUP  
TONE> CONSTANT  
RING-BACK> 20 min
```

Factory Default Setting: TONE > CONSTANT

Factory Default Setting: RING-BACK > 20 min

TONE: The sound of the audible alarm can be any of these: constant, intermittent slow or intermittent fast

RING-BACK: Time in minutes between acknowledging (muting) an alarm and when it resounds if the alarm condition is still present

### PARAMETERS: Screen 5

```
COOLING OFFSET  
ON > 0.5°C = -34.5°C  
OFF > -0.3°C = -35.3°C
```



Caution, cooling offset parameters are critical to the function of the system and should not be altered by a user or a technician without first consulting technical service.

### PARAMETERS: Screen 6

```
EVAP STATUS  
EVAP TEMP: -35.0°C
```

Displays evaporator temperature

## PARAMETERS: Screen 7

```
PASSWORD SETUP  
LEVEL> LEVEL 1
```

Note: Password level indicates how much access is granted when that password is input. Level 2 access should be set prior to Level 1 access since Level 2 allows for passwords to be managed and changed after initial setup.

LEVEL 1: Password protection for the Level 1 users allows read only access to all setpoints, alarms, and parameters

```
USER 1  
USER 2  
USER 3  
USER 4
```

LEVEL 2: Password protection for the Admin allows editable access to all setpoints, alarms and parameters.

```
PASSWORD SETUP  
LEVEL> LEVEL 2
```

IMPORTANT NOTE: The use and selection of Passwords is RECOMMENDED to protect the system from intentional or inadvertent tampering. If the passwords are not utilized, there will not be password prompting during programming. This is a security feature to protect the factory settings, and ultimately preserve the refrigerated contents.

## PARAMETERS: Screen 8

```
COMMUNICATIONS  
UNIT IDENT > 1  
BAUD RATE > 19200  
PROTOCOL>SUP RS485
```

UNIT IDENT: Sets the unit identification for serial communications.

BAUD RATE: Sets the Baud Rate for the serial communications. Baud rates supported 1200, 2400, 4800, 9600, & 19200.

## PARAMETERS: Screen 9

```
AIR TEMP CALIBRATE  
OFFSET> 0.0°C  
ACTUAL> -35.0°C
```

OFFSET: Allows calibration for the Air Temperature Sensor.

ACTUAL: Displays the current sensor reading.



## PARAMETERS: Screen 10



```
PRODUCT 1 TEMP CAL
OFFSET> 0.0°C
ACTUAL> -35.0°C
```

OFFSET: Allows calibration for the Product Temperature Sensor.

ACTUAL: Displays the current sensor reading.

There will be separate product temperature calibration screens for both upper product (1) and lower product probes.

## PARAMETERS: Screen 11



```
PRODUCT 2 TEMP CAL
OFFSET> 0.0°C
ACTUAL> -30.8°C
```

## PARAMETERS: Screen 12



```
RUN HOURS SETUP
RESET COMP RUN HRS>N
RESET FAN RUN HRS>N
RESET DEF RUN HRS>N
```

This settings screen allows the user to reset the run hours of the compressor and fan and restart the counter. This screen also allows the user to reset the defrost run hours.

## Calibration, verification, and validation



The display temperatures should be verified on start-up and periodically thereafter to assure that the unit is performing to the requirements. Comparative measurements can be accomplished by utilizing a calibrated Temperature Monitoring Device.

Next place the calibrated Temperature Monitoring Device in a medium that simulates the product being stored (per site verification / validation standards) at the appropriate process temperatures. Allow the medium and thermometer temperature to equalize before comparing the displayed product temperatures and thermometer reading. The displayed Product Temperature should read within  $\pm 1^{\circ}\text{C}$  of the calibrated device. If the displayed Product Temperature is out of range enter an offset in the Product Temperature Calibration screen.

## Alarm test with Password

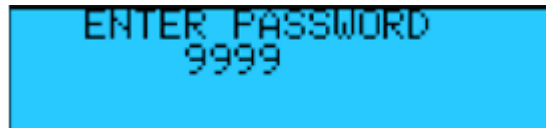
Note: If the password protection is used the following screen will be displayed before allowing access to the ALARM TEST screen. On initial startup there is no password protection the passwords are set in the PARAMETERS group. If no password protection is used the “ENTER PASSWORD” screen will not be displayed.



Press the  Enter key to move the cursor to the four-digit password. Use the Up or Down Arrow key to increase or decrease the number. When the correct password is displayed press the  Enter key to enter the password. If the correct password was entered the corresponding screen will be displayed. If a wrong password was entered “WRONG PASSWORD” will be displayed on the bottom line. The password can be re-entered or press the  Escape key to return to the System Status screen.

## Alarm Test

The Alarm Test feature of this controller will test the High and Low Temperature Alarms for the two product temperature sensors.

P1 LO TEMP TEST: Upper product sensor low temperature alarm test.

P1 HI TEMP TEST: Upper product sensor high temperature alarm test.

When the test is active the temperature will begin to rise for the high temperature alarm tests and fall for the low temperature alarm tests. The temperature will continue to rise or fall for three (3) minutes then the test will be stopped. When the temperature reaches the Alarm Set Point for the selected sensor the alarm will sound, and the display will show the alarm. The Alarm History Screen will log the temperature, time, and date that the alarm occurred.

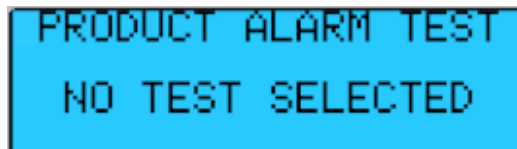

Press the ENT key to move the cursor to the NO TEST SELECTED data field. Use the Up or Down Arrow key to scroll through the tests. When the correct test is displayed press the ENT key to start the test. Press the ESC key to return to the System Status screen.



This screen will be displayed when a test is active. To end a test, press the ENT key to move the cursor to the TEST data field and use the Up or Down Arrow key to scroll through the tests until “NO TEST SELECTED” is displayed. Press the ENT key to end the test.

## ALARMS

During normal operation, should an alarm occur, the ALARM button will **glow red**, and an **audible buzzer** will sound to indicate the presence of the alarm. Pressing the ALARM button once will silence the buzzer for the period of time set for the RING BACK. If the alarm is still active after the RING BACK time has expired the buzzer will sound again. Pressing it again will bring up the first alarm screen. Successive presses of the ALARM button will bring up each alarm screen in sequence until the final screen indicating "NO MORE ALARMS, PRESS ENTER TO CLEAR ALARM". Pressing the ENTER button on the final screen then returns you to the screen that was being displayed when the alarm sounded. Most alarms are self-explanatory.

During normal operation, when no alarms are active, pressing the ALARM button will display the Alarm History screen:



The ALARM HISTORY screen will display the last alarm that has occurred. The controller will store the last 100 alarms that have occurred. To view the Alarm History Log, press the ENT button to move the cursor to the alarm #. Using the UP and Down Arrow buttons scroll through the stored alarms.

Each alarm will display the date and time of the alarm along with the product temperature (P1) when the alarm occurred.

## 4. PRODUCT SPECIFICATIONS

### 4.1 OPERATING STANDARDS

These models are designed to operate under the following conditions:

- Indoor use only
- Maximum altitude: 6562 ft. (2000 m)
- Optimal ambient conditions: 18°C to +26°C (+65°F to +78°F), <70% RH
- Short duration ambient conditions: 15°C to 32°C (59°F to 90°), <80% RH

### Electrical Specifications:

Model	Input Voltage & Frequency	Voltage Tolerance	Rated Amperage	Power Source	Remote Alarm Maximum Capacity
NSBF23WSWCR/0	115V 60 Hz	± 10%	7.0	Grounded outlet, meeting national electric code (NEC) in the U.S. and all local electrical requirements	230VAC @ 10A, 115VAC @ 10A and 30VDC @ 10A
NSBF23WSW/0					
NSBF49WSWCR/0					
NSBF49WSW/0			7.6		

### Unit Specifications:

Model	Cabinet Type	Door(s)	Gross Capacity Cu. Ft. / (L)	Exterior Dimensions W x D x H in. / (m)	Net Wt. lbs. / (kg)
NSBPF23WSW/0	Upright	Single hinged, solid	23 (650)	26.9 x 36.4 x 81.5 (683 x 925 x 2070)	355 (161)
NSBPF23WSWCR/0	Upright	Single hinged, solid	23 (650)	26.9 x 36.4 x 81.5 (683 x 925 x 2070)	360 (164)
NSBPF49WSW/0	Upright	Double hinged, solid	49 (1380)	54 x 36.8 x 81.5 (1372 x 925 x 2070)	670 (304)
NSBPF49WSWCR/0	Upright	Double hinged, solid	49 (1380)	54 x 36.8 x 81.5 (1372 x 925 x 2070)	675 (307)

## 5. MAINTENANCE



**Observe all Warning Labels. Disconnect power to eliminate injury from electrical shock when servicing equipment or cleaning.**



Important: It is critical that cleaning recommendations are followed to ensure optimal performance and longevity of the unit.

### 5.1 INSPECTION AND SERVICING

#### Periodic inspections

Every 3 months or as required:

- Check that the condenser coil is free of obstruction.

Every 6 months or as required:

- Check the controller backup battery status
- Clean the condenser coil
- Check the door gasket for proper seal
- Check drain line from evaporator pan for blockage or leaks.

#### Battery replacement

Controller backup batteries are 2x 12V rechargeable lead acid batteries connected in series to provide 24V DC power to the controller. If batteries must be replaced, replace both cells at the same time to ensure proper charging and optimum power availability.

1. Disconnect the main power cord from the wall.
2. Remove the battery fuse from the top of the unit.
3. Remove the top cover from the unit.
4. Locate the batteries near the right wall of the cabinet, held in place with a metal bracket.
5. Disconnect the wiring from the 4 battery terminals, noting the polarity of each connection.
6. Remove the 4 screws holding the metal bracket and lift the bracket away from the batteries.
7. Remove both batteries. Replace with new batteries in the same location and orientation.
8. Reverse the procedure above to restart the unit.
9. Note: a low battery voltage alarm may sound after powering on with new batteries. Wait 1 hour for the batteries to charge properly, then clear the alarm. If the battery voltage alarm persists, contact technical service.

#### Cleaning

- Never use abrasive cleaners or instruments (steel pads, wire brushes, etc.) on stainless steel interior or powder coated exterior.
- Never use acid-based cleaners, which will damage the stainless finish. Warm soapy water is best, but if cleaning solution is required, use only alkaline based cleaners.

- Avoid chlorides during cleaning which could damage the stainless-steel finish. Chlorides are commonly found in hard water, salts, and household or industrial cleaners. If cleaners with chlorides are used, rinse with clean water and dry thoroughly.
- Gaskets should be cleaned only with warm soapy water. Cleaning products could damage gaskets or cause them to embrittle over time. Never use tools which could cut or tear the gasket.
- Inspections should be performed quarterly, and the condenser cleaned as necessary to maintain good thermal transfer properties. A soft bristle can be used to loosen these particles that are attached to the grid so that they may be removed with a vacuum cleaner. Care must be taken not to damage the condenser. It is recommended that the condenser be cleaned at least once every 6 months.
- All moving parts have been permanently lubricated and will generally require no maintenance.



Important: Failure to keep the condenser coil clean and clear of obstructions could result in poor performance and possibly damage to the compressor.

## 5.2 SERVICE AND ANALYSIS GUIDE

<u>MALFUNCTION</u>	<u>POSSIBLE CAUSE</u>		<u>SOLUTION</u>	
Compressor will not start	1.	Service cord unplugged	1.	Plug in service cord
	2.	Overload tripped	2.	Determine reasons and correct
	3.	Control stuck open	3.	Repair or replace
	4.	Wiring incorrect	4.	Check wiring against the diagram
Compressor trips on overload protection	1.	Improperly wired	1.	Check wiring against the diagram
	2.	Low voltage to unit	2.	Determine reason and correct
	3.	Inverter malfunction	3.	Determine reason and replace
	4.	Relay failing to close	4.	Determine reason, correct, or replace
Compressor starts and runs, but short cycles on overload protector	1.	Low voltage to unit	1.	Determine reason and correct
	2.	Overload defective	2.	Check current, replace overload protector
	3.	Excessive head pressure	3.	Check ventilation or restriction in refrigeration system
Inverter malfunction	1.	No Power	1.	Check power / ground wiring
	2.	Frequency input error	2.	Check frequency at CCA
	3.	Improper compressor wiring	3.	Check compressor cable connections
Refrigerated space too warm	1.	Control setting too high	1.	Lower the set point
	2.	Refrigerant overcharge	2.	Reclaim and recharge
	3.	Dirty condenser	3.	Clean condenser
	4.	Evaporator coil iced	4.	Determine reason and defrost
	5.	Not operating	5.	Determine reason, replace if necessary
	6.	Air flow to condenser or evaporator blocked Control	6.	Remove obstruction for free air flow. the control
Standard temperature system and freezes the product	1.	Set point is too low	1.	Raise the set point
	2.	Control points stuck	2.	Replace the controller
Objectionable noise	1.	Fan blade hitting fan shroud	1.	Align fan and shroud or replace components
	2.	Tubing rattle	2.	Locate and reform
	3.	Vibrating fan blade	3.	Replace fan blade
	4.	Condenser fan	4.	Check motor bracket mounting, tighten. If necessary, replace components.
	5.	Worn fan motor bearings	5.	Replace fan motor
Ice buildup	1.	Poor door seal	1.	Repair or replace door gasket
	2.	Drain Line blocked	2.	Remove obstruction, defrost unit
	3.	Drain line frozen	3.	Replace insulation and/or drain heater
	4.	Defrost disabled	4.	Enable Defrost
	5.	Defrost Settings	5.	Adjust defrost termination, drip time, fan delay

## 6. WARRANTY

Horizon Scientific, Inc. warrants to the original purchaser every new Horizon Scientific, Inc. refrigerated unit, the cabinet, and all parts thereof, to be free from defects in material or workmanship, when such unit is installed, used, and maintained in accordance with provided instructions. The warranty period starts two weeks from the date of shipment from Horizon Scientific, Inc. This two-week period allows ample shipping time so that the warranty will go into effect at approximately the same time your equipment is delivered. Unless subject to prior written agreement with Horizon Scientific, Inc., this warranty does not allow for any warranty start deferment greater than two weeks from date of shipment due to a delayed installation and/or start-up. By purchasing any product from Horizon Scientific, Inc., you, and any entity for which you are purchasing acknowledge and agree to every provision contained herein, and all other Notices and Terms provided to Purchaser by Horizon Scientific, Inc., which are hereby incorporated.

### 6.1 FACTORY WARRANTY

Under this warranty, Horizon Scientific, Inc., through its authorized service organizations, will repair, or at its option, replace any part found to contain a manufacturing defect in material or workmanship without charge to the owner for parts and service labor. Replacement or repaired parts will be warranted for only the unexpired portion of the original warranty. Horizon Scientific, Inc. will not assume any shipping or cartage costs for parts under warranty. These costs shall be paid by the customer.

### 6.2 COMPRESSOR WARRANTY

In addition to the standard warranty, Horizon Scientific, Inc. warrants its hermetically and semi-hermetically sealed compressors to be free from defects in both material and workmanship under normal use and service in addition to the standard warranty period. Compressors determined by Horizon Scientific, Inc. to have been defective within this extended time period will, at Horizon Scientific, Inc.'s option, be either repaired or replaced with a compressor or compressor parts of similar design and capacity.

The compressor warranty applies only to hermetically and semi-hermetically sealed parts of the compressor and does not apply to any other parts or components, including, but not limited to, cabinet, paint finish, temperature control, refrigerant, metering device, driers, motor starting equipment, fan assembly or any other electrical components.

Horizon Scientific, Inc.'s sole obligation under this warranty is limited to either repair or replacement of parts, subject to the additional limitations below.

This warranty neither assumes nor authorizes any person to assume obligations other than expressly covered by this warranty.

### 6.3 ADDITIONAL WARRANTY INFORMATION

**NO CONSEQUENTIAL DAMAGES.** Horizon Scientific, Inc. is not responsible for economic loss; profit loss; or special, indirect, or consequential damages, including without limitation, losses or damages arising from contents spoilage claims whether because of refrigeration failure, electrical failure, power failure, or compressor failure.



HORIZON SCIENTIFIC, INC.'S MAXIMUM CUMULATIVE LIABILITY RELATIVE TO ALL CLAIMS AND LIABILITIES, INCLUDING OBLIGATIONS UNDER ANY INDEMNITY, WHETHER OR NOT INSURED, SHALL NOT EXCEED THE COST OF THE PRODUCT(S) GIVING RISE TO THE CLAIM OR LIABILITY.

**WARRANTY IS NOT TRANSFERABLE.** This warranty is not assignable and applies only in favor of the original purchaser/user to whom delivered. Any such assignment or transfer shall void the warranties herein made and shall void all warranties, express or implied, including any warranty of merchantability of fitness for a purpose.

**NO IMPLIED WARRANTY OF MERCHANTABILITY OF FITNESS FOR A PARTICULAR PURPOSE.** There are no other warranties, express, implied, or statutory, except the standard warranty and the additional compressor warranty as described above. These warranties are exclusive and in lieu of all other warranties, including implied warranty and merchantability of fitness for a purpose. There are no warranties which extend beyond the description on the face hereof, whether based on contract, warranty, tort (including negligence), strict liability, indemnity, or any other legal theory, and whether arising out of warranties, representations, instructions, installations, or non-conformities from any cause. Purchaser further acknowledges that the purchase price of the Product reflects these warranty terms and remedies.

**ALTERATION, NEGLIGENCE, ABUSE, MISUSE, ACCIDENT, DAMAGE DURING TRANSIT OR INSTALLATION, FIRE, FLOOD OR OTHER EXTERNAL CAUSES.**

Horizon Scientific, Inc. is not responsible for the repair or replacement of any parts that Horizon Scientific, Inc. determines have been subjected after the date of manufacture to alteration, neglect, abuse, misuse, accident, damage during transit or installation, fire, flood, or other external causes. It does not apply to defects resulting from failure to properly install, operate or maintain the product in accordance with the printed instructions provided, or damage caused by the storage of any corrosive material that comes in contact with the interior or exterior portions of the cabinet, or the use of spark producing equipment or containers (such as galvanized or carbonized steel containers) that come in contact with any interior portion of the cabinet.

**OUTSIDE U.S./CANADA.** This warranty does not apply to, and Horizon Scientific, Inc. is not responsible for, any warranty claims made on products sold or used outside the United States and Canada.

**CHOICE OF LAW/VENUE.** The laws of the State of South Carolina shall govern the validity, interpretation, and enforcement of this warranty, regardless of conflicts of law principles. Purchaser agrees that proper venue for any action to enforce the terms of this warranty shall be the Dorchester County District Courts, South Carolina. Purchaser submits the jurisdiction of such courts over the Purchaser and the subject matter of any such action. Any action for breach of these warranty provisions must be commenced within one (1) year after that cause of action has accrued.

## **6.4 WARRANTY CLAIMS**

To obtain prompt warranty service, simply contact the manufacturer at 800-648-4041. Horizon Scientific, Inc.'s shipping records showing date of shipment shall be conclusive in establishing the warranty period. All claims should include model number of the unit, the serial number of the cabinet, proof of purchase, date of installation, and all pertinent information supporting the existence of the alleged defect. Any repairs must be authorized by Horizon for the warranty to be honored.

This page left intentionally blank.

# 7. COMPLIANCE

## 7.1 APPLICATION

**FDA:** FDA listed Class II medical device, 21CFR part 820 compliant

**AABB:** Conforms to the requirements set forth by AABB for refrigerated blood products cold storage

## 7.2 SAFETY

**Safety testing:** This unit is safety certified by Intertek ETL, CETL Listed  (certified to UL471 standard, hydrocarbon refrigerant safety).

**Microprocessor controller:** Complies with the following additional standards electrical safety: EN 60730-1, EN 60730-2-9, EN 61010-1, UL60730. **Electromagnetic compatibility:** EN 61000-6-1, EN 61000-6-2, EN 61000-6-2/EC, EN 61000-6-2/IS1, EN 61000-6-3, EN 61000-6-4; EN 55014-1, EN 55014-2, EN 55014-2/EC, EN 55014-2/A1, EN 55014-2/IS1, EN 55014-2/A2

## 7.3 ENVIRONMENTAL

**EPA:** The refrigerant and foaming agents used in this product EPA SNAP compliant hydrocarbon.

**Microprocessor controller:** Complies with the following additional standards electromagnetic compatibility standards: EN 61000-6-1, EN 61000-6-2, EN 61000-6-2/EC, EN 61000-6-2/IS1, EN 61000-6-3, EN 61000-6-4; EN 55014-1, EN 55014-2, EN 55014-2/EC, EN 55014-2/A1, EN 55014-2/IS1, EN 55014-2/A2

## **CONTACT US**

Technical Support: 1-800-648-4041 x5

Customer Support: 1-800-648-4041 x3  
[technicalservice@horizonscientific.com](mailto:technicalservice@horizonscientific.com)