

100-214-294
Rev. 3

Ultrasonic Bath
Models 1800, 2800, 3800, 5800, 8800

Operator's Manual
www.Bransonic.com

Limited Warranty

Subject to the limitations outlined below, Branson warrants that the Ultrasonic Baths will be free from defects in material and workmanship under normal use and regular service and maintenance for a period of **twenty four (24) months from the date of shipment**. Branson does not warrant that the operation of the software shall be uninterrupted or error free. THIS IS THE SOLE AND EXCLUSIVE WARRANTY GIVEN WITH RESPECT TO THE ULTRASONIC BATHS AND IS IN LIEU OF AND EXCLUDES ALL OTHER WARRANTIES, EXPRESS OR IMPLIED, ARISING BY OPERATION OF LAW OR OTHERWISE, INCLUDING WITHOUT LIMITATION, MERCHANTABILITY AND FITNESS FOR A PARTICULAR PURPOSE WHETHER OR NOT THE PURPOSE OR USE HAS BEEN DISCLOSED TO BRANSON.

This warranty does not extend to any losses or damages due to misuse, accident, abuse, neglect, normal wear and tear, negligence (other than Branson's), unauthorized modification or alteration, use beyond rated capacity, unsuitable power sources or environmental conditions, improper installation, repair, handling, maintenance or application or any other cause not the fault of Branson. If within thirty (30) days after discovery of any warranty defects within the warranty period, the Customer notifies Branson thereof in writing, Branson shall, at its option and as the Customer's exclusive remedy, repair, correct or replace, or refund the purchase price for, that portion of the product found by Branson to be defective. Failure by the Customer to give such written notice within the applicable time period shall be deemed an absolute and unconditional waiver of the Customer's claim for such defects. The Customer must return the product to one of the Branson service centers, whose addresses are provided on page 55 of this manual. The Customer will be responsible for freight sending the unit to the service center. The service center will send the unit back to the Customer with freight prepaid.

Branson's liability, whether based on warranty, negligence, tort or strict liability, or other cause, arising out of and/or incidental to sale, use or operation of the transducer elements, or any part thereof, shall not in any case exceed the cost of repair or replacement of the defective equipment, and such repair or replacement shall be the exclusive remedy of the purchaser, and in no case shall Branson be responsible for any and/or all

consequential punitive or incidental damages including without limitation, and/or any consequential damages arising out of commercial losses.

 **WARNING** 

- Do not place parts or containers directly on the bottom of the tank; use a tray or wire to suspend items. Direct placement can cause the units to fail.
- Do not allow the solution to drop more than 3/8 inch (1 cm) below the operating level line.
- Do not ever use alcohol, gasoline or flammable solutions. Doing so could cause a fire or explosion. Use only water-based solutions.
- Do not use mineral acids. These could damage the tank.

Contents

Front
Cover

Limited Warranty

1	Safety Precautions
3	Introduction
3	Ultrasonic Baths
4	Accessories For Your Unit
4	Unpacking Your Unit
4	Installing Your Unit
5	How Ultrasonics Works
6	Model Name Definition
7	Equipment Specifications (North America Models)
8	Equipment Specifications (Europe Models)
9	Equipment Specifications (Japan Models)
10	Equipment Specifications (China Models)
11	Fuse Table (North America and Japan Models)
12	Fuse Table (Europe and China Models)
13	Operating Your Ultrasonic Bath
13	M Series: Before You Begin
14	M Series: Explanation of Controls
15	M Series: Operating your Unit
16	MH Series: Before You Begin
17	MH Series: Explanation of Controls
18	MH Series: Operating your Unit
19	CPX Series: Before You Begin
20	CPX Series: Explanation of Controls
22	CPX Series: LCD Description
23	CPX Series: Operating your Unit
25	CPXH Series: Before You Begin
26	CPXH Series: Explanation of Controls
31	CPXH Series: LCD Description
33	CPXH Series: Operating your Unit
38	Draining Your Unit
40	Optimizing Your Ultrasonic Bath
43	Application Hints
44	Cleaning Methods

44	Direct Cleaning Method
45	Indirect Cleaning Method
46	Non-Cleaning Application
47	Cleaning Solutions
51	Troubleshooting
55	Service Centers
58	Information for Users on Disposal of Equipment

Safety Precautions

Before using your Ultrasonic Bath, please read and thoroughly understand these safety precautions. Failure to follow them may result in serious personal injury or property damage.

To avoid electrical shock:

- Do unplug from power source before filling or emptying the tank.
- Do plug the unit into an appropriate grounded power socket.
- Do connect the unit to a power supply using a properly sized overcurrent protection device. See label on the back of unit for information on current rating.
- Do keep the control panel and the area around the unit clean and dry—wipe up solution which spills over the tank brim. Water and high voltage can cause electrical shock.
- Do not operate the unit without proper grounding.
- Do not remove the grounding prong on the line cord plug.
- Do not disassemble your unit—high voltage inside the unit is dangerous.
- Do not immerse the unit in water.

To prevent personal and/or property damage:

- Do use water-based solutions.
- Do not ever use alcohol, gasoline or flammable solutions. Doing so could cause a fire or explosion and will void your warranty. Use only water-based solutions.
- Do not ever use mineral acids. These could damage the tank.
- Do not touch the stainless steel tank or cleaning solution—they may be hot.
- Do not allow fluid temperature to exceed 70 °C (158 °F).
- Do not place your fingers or hands into the tank while the unit is operating. Doing so may cause discomfort and possible skin irritation. Avoid contact with solutions and provide adequate ventilation.
- Do not use solutions containing chlorine bleach.

To prevent damage to the unit:

- Do change your solution regularly.
- Do not cover vents on the cover.
- Do not operate the unit dry.
- Do not place parts or containers directly on the bottom of the tank; use a tray or wire to suspend items. Failure to comply may cause transducer damage and will void your warranty.
- Do not allow the solution to drop more than 3/8 inch (1 cm) below the operating level line with heat or ultrasonics on. Failure to comply may cause transducer and/or heater damage and will void your warranty.
- Turn off AC and heater switch before plugging/unplugging the line cord.

Sound level and energy savings

- Do not operate the unit without a cover when possible
- The sound pressure released by the unit depends on the size of the bath and the application, but is less than 80 dBA when used with a cover.
- To reduce the sound pressure it is recommended to use a cover while ultrasonics are activated and to switch the ultrasonics on with the bath loaded when possible.

Introduction

Ultrasonic Baths

This line of ultrasonic baths includes five sizes:

Model Number	Tank Capacity
1800	1/2 gal. (1.91 l)
2800	3/4 gal. (2.81 l)
3800	1-1/2 gal. (5.71 l)
5800	2-1/2 gal. (9.51 l)
8800	5-1/2 gal. (20.81 l)

Each model is constructed using durable industrial style 40 kHz transducers. These provide increased ultrasonic power along with built in sweep frequency to ensure uniform ultrasonic activity throughout the bath. Models 1800 and 2800 have a molded dip in the left side of their rims to facilitate emptying of solution from the tank. Models 3800, 5800 and 8800 have built in drains and are supplied with tank drain kits. Each model can be purchased in four different configurations:

- with a Mechanical Timer (M);
- with a Mechanical Timer plus Heat (MH);
- with Digital Control and Timer (CPX);
- with Digital Control, plus Heat and Timer (CPXH).



When you first fill your unit, or refill it with fresh solution, use warm water for the solution. Turn on the heater (if available), turn on the ultrasonics (press the Sonics key or rotate the Timer), add the cover and the solution will heat quickly to temperature.

Accessories For Your Unit

As parts cannot be placed on the tank bottom, accessories include beaker positioning covers, solid and perforated insert trays, mesh baskets, beakers, and support racks.

NOTE: Tank covers are included with every unit.

Unpacking Your Unit

Please check your unit and its carton carefully for any external or internal damage. If you find damage, contact your shipping carrier immediately, before contacting your distributor. Please retain your packaging for future use.

Installing Your Unit

Check the plate on the back of the unit for correct power requirements. Position your unit within easy reach of a standard grounded electrical outlet. Do not place the unit on a circuit which could become overloaded.

If your unit does not operate correctly, first refer to the troubleshooting section on page 51 for possible causes, or contact an authorized service center listed at the end of this manual for additional information.

How Ultrasonics Works

Ultrasonic sound is sound transmitted at frequencies generally beyond the range of human hearing. In your ultrasonic bath, ultrasonic sound (sonics) can be used for cleaning materials and parts, and for dissolving, homogenizing and degassing liquids. This is how it works:

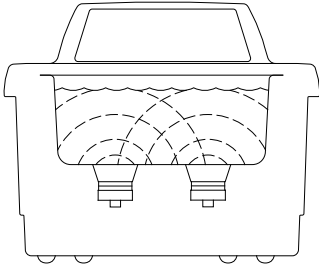

- As the sound waves from the transducer radiate through the solution in the tank, they cause alternating high and low pressures in the solution.

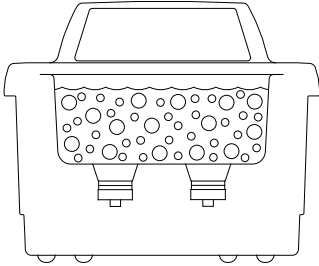

- During the low pressure stage, millions of microscopic bubbles form and grow. This process is called CAVITATION, meaning “formation of cavities”.

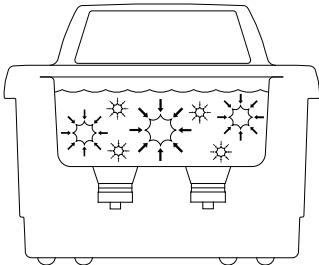

- During the high pressure stage, the bubbles collapse, or “implode” releasing enormous amounts of energy.
- For ultrasonic cleaning applications, these implosions act like an army of tiny scrub brushes. They work in all directions, attacking every surface and invading all recesses and openings.
- This same energy can be used for other applications, such as liquid dissolving, homogenizations, and degassing.

Model Name Definition

Example:

<u>CPX</u>	<u>1800</u>	<u>H</u>	<u>- E</u>
Model	Tank Capacity	Heater	Region/voltage
CPX: Digital M: Mechanical	1800: 1/2 gal. (1.91L) 2800: 3/4 gal. (2.81 l) 3800: 1-1/2 gal. (5.71 l) 5800: 2-1/2 gal. (9.51 l) 8800: 5-1/2 gal. (20.81 l)	Blank: No Heater H: With Heater	Blank: North America (120 VAC) - E: Europe (230 VAC) - J: Japan (100 VAC) - C: China (220 VAC)

NOTE:

- All models have a frequency of 40 kHz.
- In CPXH models, the temperature readout accuracy is $\pm 3\text{ }^{\circ}\text{C}$ ($\pm 5.4\text{ }^{\circ}\text{F}$).
- Models available for 120 V $\pm 10\%$, 50/60 Hz and 220 V $\pm 10\%$, 50/60 Hz operation.
- All 120 V units have CSA/UL or equivalent approval and comply with FCC regulations.
- All 220-230 V units meet CE standards.
- All units have a ground leakage current less than .50 ma.
- Operating temperature is from 5 $^{\circ}\text{C}$ to 40 $^{\circ}\text{C}$ (41 $^{\circ}\text{F}$ to 104 $^{\circ}\text{F}$).

Equipment Specifications (North America Models)

Model Name	Tank Capacity	Tank Size (Inches)	Overall Size (Inches)	Weight	Max Sonics Power	Heater Power	Max. Draw Power Req.
M1800	1/2 gal. (1.91 l)	L: 6 W: 5.5 H: 4	L: 9.9 W: 12 H: 11.9	9 lb (4 kg)	70	0	90
M1800H					70	60	150
CPX1800H					70	60	150
CPX1800					70	0	90
M2800	3/4 gal. (2.81 l)	L: 9.5 W: 5.5 H: 4	L: 13.3 W: 12 H: 11.9	10 lb (4.5 kg)	110	0	130
M2800H					110	90	250
CPX2800H					110	90	250
CPX2800					110	0	130
M3800	1-1/2 gal. (5.71 l)	L: 11.5 W: 6 H: 6	L: 15.6 W: 12.5 H: 14.8	14 lb (6.4 kg)	110	0	130
M3800H					110	180	350
CPX3800H					110	180	350
CPX3800					110	0	130
M5800	2-1/2 gal. (9.51 l)	L: 11.5 W: 9.5 H: 6	L: 15.6 W: 15.8 H: 14.9	16 lb (7.3 kg)	160	0	180
M5800H					160	280	490
CPX5800H					160	280	490
CPX5800					160	0	180
M8800	5-1/2 gal. (20.81 l)	L: 19.5 W: 11.5 H: 6	L: 23.5 W: 18.3 H: 15.4	28 lb (12.7 kg)	280	0	320
M8800H					280	560	930
CPX8800H					280	560	930
CPX8800					280	0	320

Equipment Specifications (Europe Models)

Model Name	Tank Capacity	Tank Size (mm)	Overall Size (mm)	Weight	Max Sonics Power	Heater Power	Max. Draw Power Req.
M1800-E	1.91 l (1/2 gal.)	L: 150 W: 140 H: 100	L: 251 W: 305 H: 302	5.4 kg (12 lb)	70	0	90
M1800H-E					70	60	150
CPX1800H-E					70	60	150
CPX1800-E					70	0	90
M2800-E	2.81 l (3/4 gal.)	L: 240 W: 140 H: 100	L: 338 W: 305 H: 302	6.8 kg (15 lb)	110	0	130
M2800H-E					110	110	250
CPX2800H-E					110	110	250
CPX2800-E					110	0	130
M3800-E	5.71 l (1-1/2 gal.)	L: 290 W: 150 H: 150	L: 396 W: 318 H: 376	8.2 kg (18 lb)	110	0	130
M3800H-E					110	215	350
CPX3800H-E					110	215	350
CPX3800-E					110	0	130
M5800-E	9.51 l (2-1/2 gal.)	L: 290 W: 240 H: 150	L: 396 W: 401 H: 378	9.5 kg (21 lb)	160	0	180
M5800H-E					160	300	490
CPX5800H-E					160	300	490
CPX5800-E					160	0	180
M8800-E	20.81 l (5-1/2 gal.)	L: 495 W: 290 H: 150	L: 597 W: 465 H: 391	16.3 kg (36 lb)	280	0	320
M8800H-E					280	600	930
CPX8800H-E					280	600	930
CPX8800-E					280	0	320

Equipment Specifications (Japan Models)

Model Name	Tank Capacity	Tank Size (Inches)	Overall Size (Inches)	Weight	Max Sonics Power	Heater Power	Max. Draw Power Req.
M1800-J	1.91 l (1/2 gal.)	L: 150 W: 140 H: 100	L: 251 W: 305 H: 302	4 kg (9 lb)	70	0	90
M1800H-J					70	45	135
CPX1800H-J					70	45	140
CPX1800-J					70	0	90
M2800-J	2.81 l (3/4 gal.)	L: 240 W: 140 H: 100	L: 338 W: 305 H: 302	4.5 kg (10 lb)	110	0	130
M2800H-J					110	65	205
CPX2800H-J					110	65	210
CPX2800-J					110	0	130
M3800-J	5.71 l (1-1/2 gal.)	L: 290 W: 150 H: 150	L: 396 W: 318 H: 376	6.4 kg (14 lb)	110	0	130
M3800H-J					110	130	275
CPX3800H-J					110	130	280
CPX3800-J					110	0	130
M5800-J	9.51 l (2-1/2 gal.)	L: 290 W: 240 H: 150	L: 396 W: 401 H: 378	7.3 kg (16 lb)	160	0	180
M5800H-J					160	200	405
CPX5800H-J					160	200	410
CPX5800-J					160	0	180
M8800-J	20.81 l (5-1/2 gal.)	L: 495 W: 290 H: 150	L: 597 W: 465 H: 391	12.7 kg (28 lb)	280	0	320
M8800H-J					280	400	755
CPX8800H-J					280	400	760
CPX8800-J					280	0	320

Equipment Specifications (China Models)

Model Name	Tank Capacity	Tank Size (Inches)	Overall Size (Inches)	Weight	Max Sonics Power	Heater Power	Max. Draw Power Req.
M1800-C	1.91 l (1/2 gal.)	L: 150 W: 140 H: 100	L: 251 W: 305 H: 302	5.4 kg (12 lb)	70	0	90
M1800H-C					70	55	145
CPX1800H-C					70	55	145
CPX1800-C					70	0	90
M2800-C	2.81 l (3/4 gal.)	L: 240 W: 140 H: 100	L: 338 W: 305 H: 302	6.8 kg (15 lb)	110	0	130
M2800H-C					110	105	250
CPX2800H-C					110	105	250
CPX2800-C					110	0	130
M3800-C	5.71 l (1-1/2 gal.)	L: 290 W: 150 H: 150	L: 396 W: 318 H: 376	8.2 kg (18 lb)	110	0	130
M3800H-C					110	205	350
CPX3800H-C					110	205	350
CPX3800-C					110	0	130
M5800-C	9.51 l (2-1/2 gal.)	L: 290 W: 240 H: 150	L: 396 W: 401 H: 378	9.5 kg (21 lb)	160	0	180
M5800H-C					160	285	490
CPX5800H-C					160	285	490
CPX5800-C					160	0	180
M8800-C	20.81 l (5-1/2 gal.)	L: 495 W: 290 H: 150	L: 597 W: 465 H: 391	16.3 kg (36 lb)	280	0	320
M8800H-C					280	560	930
CPX8800H-C					280	560	930
CPX8800-C					280	0	320

Fuse Table (North America and Japan Models)

Model Name	Fuse 1	Fuse 2	Fuse 3
M1800/M1800-J	250V, 2A	250V, 1.6A	250V, 1A
M1800H/M1800H-J			
CPX1800H/CPX1800H-J			
CPX1800/CPX1800-J	250V, 1.6A		
M2800/M2800-J	250V, 2.5A		
M2800H/M2800H-J			
CPX2800H/CPX2800H-J			
CPX2800/CPX2800-J	250V, 1.6A		
M3800/M3800-J	250V, 2.5A		
M3800H/M3800H-J			
CPX3800H/CPX3800H-J			
CPX3800/CPX3800-J	250V, 1.6A		
M5800/M5800-J	250V, 5A	250V, 2A	
M5800H/M5800H-J			
CPX5800H/CPX5800H-J		250V, 2.5A	
CPX5800/CPX5800-J			
M8800/M8800-J	250V, 10A	250V, 3.15A	
M8800H/M8800H-J			
CPX8800H/CPX8800H-J			
CPX8800/CPX8800-J	250V, 5A		

Fuse Table (Europe and China Models)

Model Name	Fuse 1	Fuse 2	Fuse 3
M1800-E/M1800-C	250V, 1.6A	250V, 1.6A	250V, 1A
M1800H-E/M1800H-C			
CPX1800H-E/CPX1800H-C			
CPX1800-E/CPX1800-C			
M2800-E/M2800-C	250V, 2.5A		
M2800H-E/M2800H-C			
CPX2800H-E/CPX2800H-C			
CPX2800-E/CPX2800-C	250V, 1.6A		
M3800-E/M3800-C	250V, 2.5A		
M3800H-E/M3800H-C			
CPX3800H-E/CPX3800H-C			
CPX3800-E/CPX3800-C	250V, 1.6A		
M5800-E/M5800-C	250V, 5A	250V, 2A	
M5800H-E/M5800H-C			
CPX5800H-E/CPX5800H-C			
CPX5800-E/CPX5800-C	250V, 1.6A	250V, 1.6A	
M8800-E/M8800-C	250V, 5A	250V, 2A	
M8800H-E/M8800H-C			
CPX8800H-E/CPX8800H-C			
CPX8800-E/CPX8800-C	250V, 2.5A		

Operating Your Ultrasonic Bath

If this is the first time you are using the ultrasonic bath, please read this whole section before operating your unit.

M Series Before You Begin

CAUTION

- Do not place parts or containers directly on the bottom of the tanks; use a tray or wire to suspend items. Direct placement can cause the units to fail.
- Do not allow the solution to drop more than 3/8 inch (1 cm) below the operating level line with ultrasonics on.
- Do not ever use alcohol, gasoline or flammable solutions. Doing so could cause a fire or explosion. Use only water-based solutions.
- Do not ever use mineral acids. These could damage the tank.

Failure to comply with these cautions will void your warranty.

Step	Action
1	Select your cleaning solution (refer to page 49 for solution effects on metals).
2	Allowing for the volume of the parts you will be cleaning and leaving room for cleaning solution, fill the tank with warm tap water to the operating level line.
3	Add cleaning solution to the tank water.
4	Plug the unit into a grounded outlet.
5	For maximum efficiency, refer to page 40, "Optimizing Your Ultrasonic Bath," before proceeding.

NOTE

If this is the first time you are running the unit, or if you have changed cleaning solution, you must degas the solution. If not, skip to page 15, "Cleaning Items (Treating Samples)."

M Series

Explanation of Controls

M Series Tower

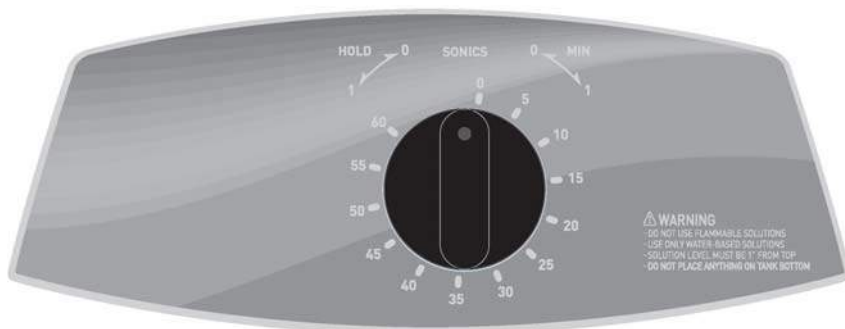

Control	Function
MAIN POWER SWITCH	<p>This switch is located on the back of the unit, next to the power cord receptacle.</p> <ul style="list-style-type: none"> • Press the I (on) side to power on the unit. • Press the O (off) side to power off the unit. <p>When operating the unit, normally leave the Main Power switch in the I (on) position, and use the Timer Knob to activate ultrasonics.</p>
TIMER KNOB	<p>Activates ultrasonics and sets time.</p> <ul style="list-style-type: none"> • Turn clockwise for timed operation (0–60 minutes). • Turn counterclockwise to the HOLD position for continuous operation. • Turn to the zero position to turn unit Off.

M Series Operating your Unit

Degassing

For initial cleaning solution degassing.

Step	Action
1	Turn Main Power switch on.
2	Turn the Timer Knob clockwise to 5–10 and let the unit run to allow the solution to “degas.” NOTE: Refer to page 41 for information on degassing.

Cleaning Items (Treating Samples)

NOTE: To stop ultrasonics at any time, turn the Timer Knob to the zero position.

Step	Action
1	Turn Main Power switch on.
2	Turn the Timer Knob clockwise to set the amount of time (0–60 minutes) you wish the items to be cleaned. Turn the Timer Knob counterclockwise to the HOLD position for continuous operation.
3	Place the items into a basket, perforated tray, or beakers in a positioning cover.
4	If using beakers or a solid tray, add cleaning solution to beakers or tray to cover the items.
5	Slowly lower the tray or beakers into the tank. Do not allow items to contact the tank bottom.
6	When items are clean, slowly remove them from the tank.
7	Rinse the clean items with clean water and dry them, if necessary.

MH Series Before You Begin

CAUTION

- Do not place parts or containers directly on the bottom of the tanks; use a tray or wire to suspend items. Direct placement can cause the units to fail.
- Do not allow the solution to drop more than 3/8 inch (1 cm) below the operating level line with heat or ultrasonics on.
- Do not ever use alcohol, gasoline or flammable solutions. Doing so could cause a fire or explosion. Use only water-based solutions.
- Do not ever use mineral acids. These could damage the tank.

Failure to comply with these cautions will void your warranty.

Step	Action
1	Select your cleaning solution (refer to page 49 for solution effects on metals).
2	Allowing for the volume of the parts you will be cleaning and leaving room for cleaning solution, fill the tank with warm tap water to the operating level line.
3	Add cleaning solution to the tank water.
4	Plug the unit into a grounded outlet.
5	For maximum efficiency, refer to page 40, "Optimizing Your Ultrasonic Bath," before proceeding.

NOTE

If this is the first time you are running the unit, or if you have changed cleaning solution, you must degas the solution. If not, skip to page 18, "Cleaning Items (Treating Samples)."

MH Series Explanation of Controls

MH Series Tower



Control	Function
MAIN POWER SWITCH	<p>This switch is located on the back of the unit, next to the power cord receptacle.</p> <ul style="list-style-type: none"> • Press the I (on) side to power on the unit. • Press the O (off) side to power off the unit. <p>When operating the unit, normally leave the Main Power switch in the I (on) position, and use the Timer Knob to activate ultrasonics.</p>
HEAT SWITCH	<p>Activates heat to 60 °C (140 °F) maximum.</p> <p>NOTE: Refer to pages 40 and 40 for further information on temperature.</p>
TIMER KNOB	<p>Activates ultrasonics and sets time.</p> <ul style="list-style-type: none"> • Turn clockwise for timed operation (0–60 minutes). • Turn counterclockwise to the HOLD position for continuous operation. • Turn to the zero position to turn unit Off.

MH Series Operating your Unit

Degassing

For initial cleaning solution degassing.

Step	Action
1	Turn Main Power switch on.
2	Turn HEAT switch on.
3	Turn the Timer Knob clockwise to 5–10 and let the unit run to allow the solution to “degas.” NOTE: Refer to page 41 for information on degassing.

Cleaning Items (Treating Samples)

NOTE: To stop ultrasonics at any time, turn the Timer Knob to the zero position.

Step	Action
1	Turn Main Power switch on.
2	Turn the Timer Knob clockwise to set the amount of time (0–60 minutes) you wish the items to be cleaned. Turn the Timer Knob counterclockwise to the HOLD position for continuous operation.
3	Place the items into a basket, perforated tray, or beakers in a positioning cover.
4	If using beakers or a solid tray, add cleaning solution to beakers or tray to cover the items.
5	Slowly lower the tray or beakers into the tank. Do not allow items to contact the tank bottom.
6	When items are clean, slowly remove them from the tank.
7	Rinse the clean items with clean water and dry them, if necessary.

CPX Series Before You Begin

▲ CAUTION ▲

- Do not place parts or containers directly on the bottom of the tanks; use a tray or wire to suspend items. Direct placement can cause the units to fail.
- Do not allow the solution to drop more than 3/8 inch (1 cm) below the operating level line with ultrasonics on.
- Do not ever use alcohol, gasoline or flammable solutions. Doing so could cause a fire or explosion. Use only water-based solutions.
- Do not ever use mineral acids. These could damage the tank.

Failure to comply with these cautions will void your warranty.

Step	Action
1	Select your cleaning solution (refer to page 49 for solution effects on metals).
2	Allowing for the volume of the parts you will be cleaning and leaving room for cleaning solution, fill the tank with warm tap water to the operating level line.
3	Add cleaning solution to the tank water.
4	Plug the unit into a grounded outlet.
5	For maximum efficiency, refer to page 40, "Optimizing Your Ultrasonic Bath," before proceeding.

NOTE







If this is the first time you are running the unit, or if you have changed cleaning solution, you must degas the solution. If not, skip to page 23, "Cleaning Items (Treating Samples)."

CPX Series







Explanation of Controls

CPX Series Tower











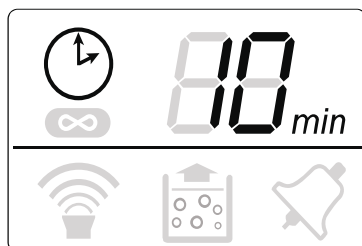



Control	Function
<p>MAIN POWER SWITCH</p>	<p>This switch is located on the back of the unit, next to the power cord receptacle.</p> <ul style="list-style-type: none"> • Press the I (on) side to power on the unit. • Press the O (off) side to power off the unit. <p>When operating the unit, normally leave the Main Power switch in the I (on) position, and use the On/Standby key to switch between the operating state and standby state.</p>
<p>ON/STANDBY</p> 	<p>When the Main Power switch on the rear panel is in the I (on) position, press to power on/off the unit.</p>
<p>UP/DOWN KEYS</p>  	<p>Press to increase/decrease ultrasonic or degassing cycle time (hold for quick increments/decrements).</p> <p>Time values are circular, pressing  from 99 minutes takes you to Constant Sonics Mode ( and "- -" on the display) and then to 1 minutes. Pressing  from 1 minutes takes you to Constant Sonics Mode and then to 99 minutes.</p> <p>During power-up, use to select high or low ultrasonic power output.</p>

Continued...

Control	Function
<p data-bbox="114 172 224 199">SONICS</p> 	<p data-bbox="247 172 932 293">Press to activate ultrasonics. If running in Timed Mode, a timer will begin to count down and ultrasonics will stop at 0 minutes. In Constant Sonics Mode (∞ and “-” on the display), timer has no function.</p> <p data-bbox="247 302 740 329">Press key again to deactivate ultrasonics.</p> <p data-bbox="247 337 937 410">If running in Timed Mode, press  and  keys to adjust the ultrasonic cycle time (adjustable from 1 to 99 minutes).</p>
<p data-bbox="120 427 219 454">DEGAS</p> 	<p data-bbox="247 427 953 516">Press to degas the solution or to run a degas application. A default timer of 5 minutes will begin to count down and degassing will stop at 0 minutes.</p> <p data-bbox="247 524 809 552">Press key again to stop degassing the solution.</p> <p data-bbox="247 560 932 633">During a degas cycle, press  and  keys to adjust the degas cycle time (adjustable from 1 to 99 minutes).</p> <p data-bbox="247 641 894 669">NOTE: Refer to page 41 for information on degassing.</p>

CPX Series LCD Description







Item	Function
 Power Level	<p>Displayed for 15 s only during power-up, shows the current ultrasonic output power selection.</p> <p>Press the Sonics () or Degas key () to go into normal operating mode.</p> <p>Press  or  key to change between high (HI) and low (LO) power ultrasonics.</p>
Sonics/ Degas Timer 	<p>Displays the duration of a timed ultrasonic or degas cycle.</p> <p>Press  and  keys to adjust ultrasonic or degassing cycle time (adjustable from 1 to 99 minutes).</p> <p>In Constant Sonics Mode, “- -” is displayed.</p>
Constant Sonics 	<p>Indicates the unit is operating in Constant Sonics Mode.</p> <p>In Constant Sonics Mode, sonics will remain on until the Sonics key is pressed or the unit is turned off.</p>
Sonics On 	<p>Indicates sonics are active.</p> <p>If running in Timed Mode, ultrasonics will remain on until the timer reaches 0 minutes.</p> <p>In Constant Sonics Mode, ultrasonics will remain on until the Sonics key is pressed or the unit is turned off.</p>
Degas On 	<p>Indicates the unit is in Degas Mode.</p> <p>In Degas Mode, degassing will continue until the timer reaches 0 minutes.</p> <p>NOTE: Refer to page 41 for information on degassing.</p>
Alarm 	<p>Alarm Bell icon flashes when the unit encounters an abnormal operating condition.</p> <p>NOTE: Refer to page 51 for information on troubleshooting.</p>

CPX Series Operating your Unit

Degassing







For initial cleaning solution degassing.

NOTE: To stop degassing at any time, press the Degas key ().

Step	Action
1	Turn Main Power switch on.
2	Press the On/Standby key () to turn on the unit.
3	<p>Press Degas key () once to start the degas process. Default degas time is 5 minutes.</p> <p>If necessary, use / keys to alter degas time during a degas cycle.</p> <p>NOTE: Refer to page 41 for information on degassing.</p>
4	After completing the degas time, you are ready to set operating parameters.

Cleaning Items (Treating Samples)

NOTE: To stop ultrasonics at any time, press the Sonics key ().

Step	Action
1	Turn Main Power switch on.
2	Press the On/Standby key () to turn on the unit.
3	<p>Set the amount of time you wish the items to be cleaned, or select Constant Sonics Mode:</p> <ul style="list-style-type: none"> • Use / keys to increase/decrease cycle time (hold for quick increments/decrements). • Pressing  key from 99 minutes or  from 1 minutes takes you to Constant Sonics Mode ( and "--" on the display).

Continued...

Step	Action
4	Press the Sonics key () to activate ultrasonics.
5	Place the items into a basket, perforated tray, or beakers in a positioning cover.
6	If using beakers or a solid tray, add cleaning solution to beakers or tray to cover the items.
7	Slowly lower the tray or beakers into the tank. Do not allow items to contact the tank bottom.
8	When items are clean, slowly remove them from the tank.
9	Rinse clean items with clean, warm water and dry, if necessary.

CPX Series Before You Begin

CAUTION

- Do not place parts or containers directly on the bottom of the tanks; use a tray or wire to suspend items. Direct placement can cause the units to fail.
- Do not allow the solution to drop more than 3/8 inch (1 cm) below the operating level line with heat or ultrasonics on.
- Do not ever use alcohol, gasoline or flammable solutions. Doing so could cause a fire or explosion. Use only water-based solutions.
- Do not ever use mineral acids. These could damage the tank.

Failure to comply with these cautions will void your warranty.

Step	Action
1	Select your cleaning solution (refer to page 49 for solution effects on metals).
2	Allowing for the volume of the parts you will be cleaning and leaving room for cleaning solution, fill the tank with warm tap water to the operating level line.
3	Add cleaning solution to the tank water.
4	Plug the unit into a grounded outlet.
5	For maximum efficiency, refer to page 40, "Optimizing Your Ultrasonic Bath," before proceeding.







NOTE

If this is the first time you are running the unit, or if you have changed cleaning solution, you must degas the solution. If not, skip to page 34, "Cleaning Items (Treating Samples) in Timed Sonics Mode."









CPXH Series Explanation of Controls

CPXH Series Tower





Control	Function
<p>MAIN POWER SWITCH</p>	<p>This switch is located on the back of the unit, next to the power cord receptacle.</p> <ul style="list-style-type: none"> • Press the I (on) side to power on the unit. • Press the O (off) side to power off the unit. <p>When operating the unit, normally leave the Main Power switch in the I (on) position, and use the On/Standby key to switch between the operating state and standby state.</p>
<p>ON/STANDBY</p> 	<p>When the Main Power switch on the rear panel is in the I (on) position, press to power on/off the unit.</p>
<p>UP/DOWN KEYS</p> 	<p>Press to increase/decrease ultrasonic or degassing cycle time (hold for quick increments/decrements).</p> <p>Time values are circular, pressing  from 99 minutes takes you to 1 minutes. Pressing  from 1 minutes takes you to 99 minutes.</p> <p>If the Fn key was pressed, use the / keys to adjust function settings.</p>





Continued...

Control	Function
<p data-bbox="136 172 203 196">HEAT</p> 	<p data-bbox="245 172 870 228">Press to turn heater on/off. Heater will shut off when set temperature is attained.</p>
<p data-bbox="118 306 221 331">SONICS</p> 	<p data-bbox="245 306 944 461">Press to activate ultrasonics. If running in Timed Mode, a timer will begin to count down and ultrasonics will stop at 0 minutes. In Constant Sonics Mode (∞ and "- - -" on the display), timer has no function. Press key again to deactivate ultrasonics.</p> <p data-bbox="245 472 944 537">If running in Timed Mode, press  and  keys to adjust the ultrasonic cycle time (adjustable from 1 to 99 minutes).</p>
<p data-bbox="123 566 215 591">DEGAS</p> 	<p data-bbox="245 566 923 683">Press to degas the solution or to run a degas application. The degas timer will begin to count down from its current setting and degassing will stop at 0 minutes. Press key again to stop degassing the solution.</p> <p data-bbox="245 695 955 760">During a degas cycle, press  and  keys to adjust degas time (adjustable from 1 to 99 minutes).</p> <p data-bbox="245 771 894 797">NOTE: Refer to page 41 for information on degassing.</p>
<p data-bbox="134 818 205 842">AUTO</p> 	<p data-bbox="245 818 923 875">Press to begin an auto cycle. In Auto Mode, the following actions are carried out automatically by the controller:</p> <ul data-bbox="245 886 955 1097" style="list-style-type: none"> <li data-bbox="245 886 902 912">• Heater is turned on to bring bath to set temperature. <li data-bbox="245 924 955 1037">• When set temperature is reached, ultrasonics are activated. The unit will abort the auto cycle and flash the  icon if set temperature is not reached within a 120-minute period. <li data-bbox="245 1049 955 1097">• When ultrasonics timer reaches 0 minutes, the auto cycle is finished. <p data-bbox="245 1109 955 1195">If at any point during an auto cycle the degas key is pressed, a degas cycle will begin. If ultrasonics has already started, the ultrasonics timer will restart after the degas period.</p>

Continued...





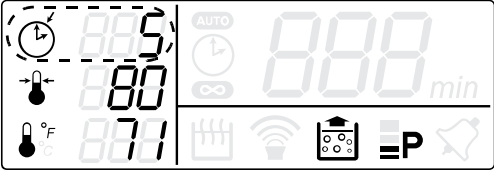

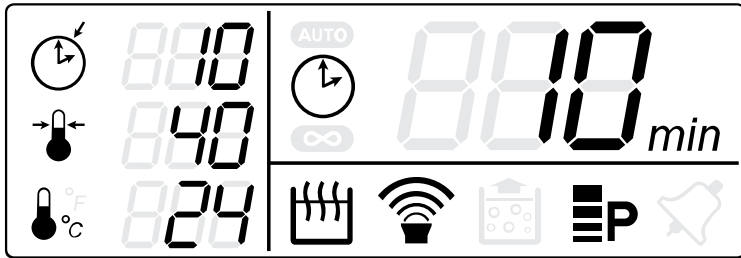

Control	Function
<p data-bbox="96 168 240 201">FUNCTION</p> <div data-bbox="139 212 200 282" style="border: 1px solid black; padding: 5px; display: inline-block; margin-bottom: 10px;">Fn</div>	<p data-bbox="240 168 965 201">Press the Fn key to access less-frequently used functions.</p> <div data-bbox="348 212 855 743" style="text-align: center;"> <pre> graph TD RS[Ready State] -- "(Set Sonics Time)" --> J(()) J -- "Fn 6x" --> SDT[Set Degas Time] J -- "Fn 1x" --> ST[Set Target Temp.] ST -- "Fn 2x" --> CSC[Set Constant Sonics] CSC -- "Fn 3x" --> SPL[Set Power Level] SPL -- "Fn 4x" --> STU[Sel. Temp. Units] STU -- "Fn 5x" --> SDT SDT -- "Fn 6x" --> RS </pre> </div> <p data-bbox="240 751 965 941"> The appropriate icon will flash to indicate which option is selected. If no key is pressed after 15 seconds the unit will save any changes and return to the Ready state. Press the Fn key again after making any changes to scroll through the rest of the options and return to the Ready state. </p> <p data-bbox="240 971 965 1003">The following options are available:</p> <ul data-bbox="240 1011 965 1084" style="list-style-type: none"> • Set Temperature: Press  and  keys to increase/decrease the bath set temperature. <div data-bbox="354 1105 770 1179" style="display: flex; justify-content: space-around; align-items: center;"> <div data-bbox="354 1105 492 1179" style="border: 1px solid black; padding: 5px; display: inline-block;">Fn (1x)</div> <div data-bbox="614 1105 770 1179" style="border: 1px dashed black; border-radius: 50%; padding: 5px; display: inline-block;">Indicates Blinking</div> </div> <div data-bbox="354 1198 852 1365" style="border: 1px solid black; padding: 5px; margin-top: 10px;"> </div> <p data-bbox="817 1385 965 1417" style="text-align: right;">Continued...</p>

Control	Function
<p data-bbox="96 168 242 196">FUNCTION</p> <div data-bbox="139 212 200 282" style="border: 1px solid black; padding: 5px; width: fit-content; margin: 10px auto;">Fn</div>	<ul style="list-style-type: none"> <li data-bbox="253 180 934 293"> <p>• Timed/Constant Sonics: Press △ key to select Constant Sonics Mode (∞ and “- - -” on the display). Press ▽ key to select Timed Sonics Mode.</p> <div data-bbox="355 321 770 391" style="display: flex; align-items: center; margin: 10px 0;"> <div style="border: 1px solid black; padding: 5px; margin-right: 10px;">Fn (2x)</div> <div style="border: 1px dashed black; border-radius: 50%; padding: 5px; text-align: center;">Indicates Blinking</div> </div> <div data-bbox="355 412 852 581" style="border: 1px solid black; padding: 5px; margin: 10px 0;"> </div> <li data-bbox="253 613 898 727"> <p>• Full/Low Power: Press △ key to select full power ultrasonic output. Press ▽ key to select low power ultrasonic output.</p> <div data-bbox="355 748 770 818" style="display: flex; align-items: center; margin: 10px 0;"> <div style="border: 1px solid black; padding: 5px; margin-right: 10px;">Fn (3x)</div> <div style="border: 1px dashed black; border-radius: 50%; padding: 5px; text-align: center;">Indicates Blinking</div> </div> <div data-bbox="355 839 852 1008" style="border: 1px solid black; padding: 5px; margin: 10px 0;"> </div> <li data-bbox="253 1040 944 1122"> <p>• Temperature Units: Press △ key to select Fahrenheit (°F). Press ▽ key to select Celsius (°C).</p> <div data-bbox="355 1143 770 1213" style="display: flex; align-items: center; margin: 10px 0;"> <div style="border: 1px solid black; padding: 5px; margin-right: 10px;">Fn (4x)</div> <div style="border: 1px dashed black; border-radius: 50%; padding: 5px; text-align: center;">Indicates Blinking</div> </div> <div data-bbox="355 1234 852 1403" style="border: 1px solid black; padding: 5px; margin: 10px 0;"> </div> <p data-bbox="809 1425 955 1453" style="text-align: right;">Continued...</p>







Control	Function
<p data-bbox="96 168 242 201">FUNCTION</p> <div data-bbox="139 212 200 282" style="border: 1px solid black; padding: 5px; width: fit-content; margin: 10px auto;">Fn</div>	<ul style="list-style-type: none"> <li data-bbox="253 180 932 370"> <p>• Degas Time: Press / keys to increase/decrease degas time (hold for quick increments/decrements). Time values are circular, pressing  from 99 minutes takes you to 1 minutes. Pressing  from 1 minutes takes you to 99 minutes.</p> <div style="display: flex; justify-content: space-around; align-items: center; margin: 10px 0;"> <div data-bbox="355 396 493 467" style="border: 1px solid black; padding: 5px;">Fn (5x)</div> <div data-bbox="614 402 770 474" style="border: 1px dashed black; border-radius: 50%; padding: 5px;">Indicates Blinking</div> </div> 

CPXH Series LCD Description



Item	Function
<p>Sonics/ Degas Set Time</p> 	<p>Displays the set time for a timed ultrasonic or degas cycle. Press  and  keys to adjust ultrasonic or degassing cycle time (adjustable from 1 to 99 minutes). In Constant Sonics Mode, “- - -” is displayed.</p>
<p>Set Temperature</p> 	<p>Displays the target temperature. Temperature units are indicated by the °F (for Fahrenheit) or °C (for Celsius) right of the Current Temperature icon.</p>
<p>Current Temperature</p> 	<p>Displays the current tank temperature as measured by the unit. Temperature units are indicated right of the icon as either °F (For Fahrenheit) or °C (for Celsius). Units can be switched using the Fn key. See Fn key description on page 29.</p>
<p>Sonics/ Degas Timer</p> 	<p>Displays the remaining time of a running timed ultrasonic or degas cycle. Press  and  keys to adjust ultrasonic or degassing cycle time (adjustable from 1 to 99 minutes).</p>

Continued...









Item	Function
<p>Auto</p> 	<p>Indicates the unit is in Auto Mode. In Auto Mode, the following actions are carried out automatically by the controller:</p> <ul style="list-style-type: none"> • Heater is turned on to bring bath to set temperature. • When set temperature is reached, ultrasonics are activated. The unit will abort the auto cycle and flash the AUTO icon if set temperature is not reached within a 120-minute period. • When ultrasonics timer reaches 0 minutes, the auto cycle is finished. <p>If at any point during an auto cycle the degas key is pressed, a degas cycle will begin. If ultrasonics has already started, the ultrasonics timer will restart after the degas period.</p>
<p>Constant Sonics</p> 	<p>Indicates the unit is operating in Constant Sonics Mode. In Constant Sonics Mode, ultrasonics will remain on until the Sonics key is pressed or the unit is turned off.</p>
<p>Heat</p> 	<p>Indicates the heater is on. Heater will shut off when set temperature is attained.</p>
<p>Sonics On</p> 	<p>Indicates sonics are active.</p> <p>If running in Timed Mode, ultrasonics will remain on until the timer reaches 0 minutes.</p> <p>In Constant Sonics Mode, ultrasonics will remain on until the Sonics key is pressed or the unit is turned off.</p>
<p>Degas On</p> 	<p>Indicates the unit is in Degas Mode.</p> <p>In Degas Mode, degassing will continue until the timer reaches 0 minutes.</p> <p>NOTE: Refer to page 41 for information on degassing.</p>
<p>Power Level</p> 	<p>Indicates the ultrasonic power output selection:</p> <ul style="list-style-type: none"> • Four bars indicate high power ultrasonics. • Two bars indicate low power ultrasonics.
<p>Alarm</p> 	<p>Alarm Bell icon flashes when the unit encounters an abnormal operating condition.</p> <p>NOTE: Refer to page 51 for information on troubleshooting.</p>

CPXH Series Operating your Unit

Degassing

For initial cleaning solution degassing.

NOTE: To stop degassing at any time, press the Degas key ()













Step	Action
1	Turn Main Power switch on.
2	Press the On/Standby key () to turn on the unit.
3	Default degas time is 5 minutes. To change the degas time, press the Fn key until the Degas icon () appears and the Set Time icon () flashes. Then press the  /  keys to change the degas time.
4	Press Degas key () once to start the degas process. If necessary, use  /  keys to alter degas time during a degas cycle. NOTE: Refer to page 41 for information on degassing.
5	After completing the degas time, you are ready to set operating parameters.

Ultrasonic Operating Modes

Mode	Action
Timed Sonics	In Timed Sonics Mode, a timer will begin to count down and ultrasonics will remain on until the timer reaches 0 minutes. For instructions on operating in Timed Sonics Mode, see page 34.
Constant Sonics	In Constant Sonics Mode ultrasonics will remain on until the Sonics key is pressed or power is turned off to the unit. For instructions on operating in Constant Sonics Mode, see page 35.
Auto	In Auto mode ultrasonics will start once set temperature is attained. Ultrasonics will remain on until the timer reaches 0 minutes. For instructions on operating in Auto Mode, see page 36.













Cleaning Items (Treating Samples) in Timed Sonics Mode

NOTE: To stop ultrasonics at any time, press the Sonics key ()

Step	Action
1	Turn Main Power switch on.
2	Press the On/Standby key () to turn on the unit.
3	If necessary degas the liquid. See page 33 for instructions.
4	Set the amount of time you wish the items to be cleaned: <ul style="list-style-type: none">• Use / keys to increase/decrease cycle time (hold for quick increments/decrements).
5	Set the tank temperature: <ul style="list-style-type: none">• Press the Fn key until the Set Temperature icon () flashes.• Press the / keys to alter the setting to the tank temperature you wish to reach.• Press the HEAT key () once to activate heat. The Heat icon () appears. <p>NOTE: Units can be switched between °F or °C using the Fn key. See Fn key description on page 29.</p>
6	Set the ultrasonic power level: <ul style="list-style-type: none">• Press the Fn key until the Power Level icon () flashes.• Press the  key to select high power ultrasonics or press the  key to select low power ultrasonics.
7	Press the Sonics key () to activate ultrasonics.
8	Place the items into a basket, perforated tray, or beakers in a positioning cover.
9	If using beakers or a solid tray, add cleaning solution to beakers or tray to cover the items.
10	Slowly lower the tray or beakers into the tank. Do not allow items to contact the tank bottom.
11	When items are clean, slowly remove them from the tank.
12	Rinse clean items with clean, warm water and dry, if necessary.













Cleaning Items (Treating Samples) in Constant Sonics Mode

NOTE: To stop ultrasonics at any time, press the Sonics key ()

Step	Action
1	Turn Main Power switch on.
2	Press the On/Standby key () to turn on the unit.
3	If necessary degas the liquid. See page 33 for instructions.
4	Change sonics mode: <ul style="list-style-type: none"> • Press the Fn key until the Constant Sonics icon () and the Set Time icon () flash. • Press the  key to select Constant Sonics Mode.
5	Set the tank temperature: <ul style="list-style-type: none"> • Press the Fn key until the Set Temperature icon () flashes. • Press the / keys to alter the setting to the tank temperature you wish to reach. • Press the HEAT key () once to activate heat. The Heat icon () appears. <p>NOTE: Units can be switched between °F or °C using the Fn key. See Fn key description on page 29.</p>
6	Set the ultrasonic power level: <ul style="list-style-type: none"> • Press the Fn key until the Power Level icon () flashes. • Press the  key to select high power ultrasonics or press the  key to select low power ultrasonics.
7	Press the Sonics key () to activate ultrasonics.
8	Place the items into a basket, perforated tray, or beakers in a positioning cover.
9	If using beakers or a solid tray, add cleaning solution to beakers or tray to cover the items.
10	Slowly lower the tray or beakers into the tank. Do not allow items to contact the tank bottom.
11	When items are clean, slowly remove them from the tank.
12	Rinse clean items with clean, warm water and dry, if necessary.









Cleaning Items (Treating Samples) in Auto Mode

NOTE: To stop ultrasonics at any time, press the Sonics key ()

Step	Action
1	Turn Main Power switch on.
2	Press the On/Standby key () to turn on the unit.
3	If necessary degas the liquid. See page 33 for instructions.
4	Set the amount of time you wish the items to be cleaned: <ul style="list-style-type: none"> Use / keys to increase/decrease cycle time (hold for quick increments/decrements).
5	Set the tank temperature: <ul style="list-style-type: none"> Press the Fn key until the Set Temperature icon () flashes. Press the / keys to alter the setting to the tank temperature you wish to reach. Press the HEAT key () once to activate heat. The Heat icon () appears. <p>NOTE: Units can be switched between °F or °C using the Fn key. See Fn key description on page 29.</p>
6	Set the ultrasonic power level: <ul style="list-style-type: none"> Press the Fn key until the Power Level icon () flashes. Press the  key to select high power ultrasonics or press the  key to select low power ultrasonics.
7	Press the Auto key () to begin Auto Cycle. Heater will turn on and sonics will start once set temperature is attained.
8	Place the items into a basket, perforated tray, or beakers in a positioning cover.
9	If using beakers or a solid tray, add cleaning solution to beakers or tray to cover the items.
10	Slowly lower the tray or beakers into the tank. Do not allow items to contact the tank bottom.
11	When items are clean, slowly remove them from the tank.
12	Rinse clean items with clean, warm water and dry, if necessary.

CPXH Temperature Calibration

The CPXH unit temperature measurement is factory calibrated. Use the following instructions to perform periodic calibrations:

Step	Action
1	The ultrasonic bath liquid may be at room temperature or may be heated-up to a desired operating temperature (e.g. 40 °C).
2	Press the Fn key 4 times until the Current Temperature icon () starts blinking. Press the  key to select °F. Press the Fn key 2 more times to return to the Ready State.
3	Press the On/Standby key () to turn off the unit.
4	Simultaneously, press both the On/Standby () and the Fn key. Only the bottom left digits and the Current Temperature icon () should turn on.
5	Stir the solution for 15 seconds to ensure thermal uniformity.
6	Wait 2 minutes after turning the unit on before taking measurements. This allows for the display to be properly updated.
7	Use the  /  keys to change the display temperature to match the actual tank temperature.
8	Press the On/Standby key () to end calibration.

Draining Your Unit



WARNING

Do not immerse the unit in water.
Unplug the unit from the power source.

Models 1800 and 2800 do not have a drain. To empty, use the indented side of the rim to pour the used solution into a waste disposal unit, rinse the tank thoroughly and refill with new solution.



Models 3800, 5800, and 8800 include a drain and valve kit.

Step	Action
1	Place the unit to allow easy reach of the drain tube into a waste disposal unit.
2	Remove the thread protecting cap from the end of the unit's drain pipe. This will expose the white teflon sealing tape on the drain pipe's threads.

Continued...

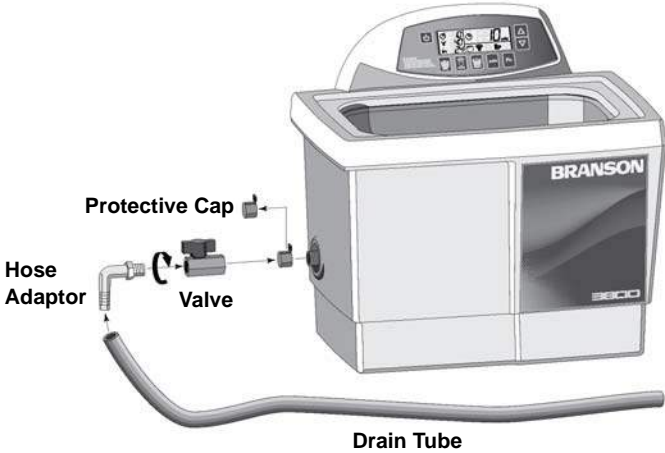
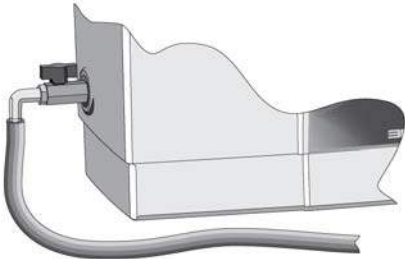
Step	Action
3	<p>Hand tighten the drain valve onto the drain pipe over the white teflon sealing tape. Finish tightening the valve in place using an adjustable or a 21mm wrench. Tighten the valve no more than one full turn when using the wrench until the handle is on top.</p> <p>CAUTION: Over tightening of the valve can cause damage to the ultrasonic tank. Always use teflon sealing tape or a sealing paste designed for use with stainless steel if retightening or refitting of the drain valve is required.</p> 
4	<p>Hand tighten the hose adaptor into the end of the drain valve. Slide the drain tube over the barbed hose adaptor end.</p> 
5	<p>Close the drain valve by turning the handle perpendicular to the valve body and the unit is ready to fill with solution. To open the valve and drain the tank, turn the handle so that it is in line with the valve body.</p>

Optimizing Your Ultrasonic Bath

Tanks

Cleaning - check the tank for contamination whenever you change solution. If necessary, remove contaminants with a nonabrasive cloth and water.

Emptying - always unplug the unit before emptying the tank. Empty the solution into a waste disposal unit.

Filling - always unplug the line cord before filling the tank. Fill the tank to the operating level (with beaker/tray in place), using warm tap water.

Low solution level - will cause the unit to fail. When you remove heavy or bulky loads from the tank, the solution level may drop below the operating level. If so, be sure to replace lost solution and degas, if necessary, depending on the amount used.

Overload - do not rest any items on the tank bottom. Weight on the tank bottom dampens sound energy and will cause damage to the transducer. Instead, use a tray and/or beaker positioning cover to support all items. Allow at least 1 inch (2.5 cm) between the tank bottom and the beaker or receptacle for adequate cavitation.

Covers - allow the unit to heat up faster, to a higher temperature, and avoid excessive liquid evaporation. However, obstructing the cover vents will cause the unit to overheat.

Temperature

Heater - the heater may cause some discoloration of the tank wall. This is normal and will not affect the performance of the unit.

Solution - the fastest method to heat your ultrasonic bath is to fill with warm solution, use heat, ultrasonics (which also adds heat), and a cover.

Over temperature protection (CPXH only) - the unit will shut down at 75 °C (167 °F) and display will go blank with only the Alarm icon remaining on. Turn the unit off and allow it to cool down. For a faster cooldown, replace some of the warm solution with cold solution.

Solution Temperature Measurement

The following instructions provide an accurate method to obtain consistent thermal measurements using a calibrated temperature measurement instrument. These readings can be used for cleaning process control or to verify the accuracy of the CPXH temperature readings.

Step	Action
1	Ensure that sonics and heaters are off.
2	Stir the solution for 15 seconds to ensure thermal uniformity.
3	For CPXH models, wait 2 minutes after turning the unit on before taking measurements. This allows for the display to be properly updated.
4	Suspend a thermocouple in the bath without allowing the probe to touch the tank walls.

Solution

Solution activity - the amount of visible activity is not necessarily related to optimum cavitation for cleaning.

Degassing 1 - fresh solutions contain many dissolved gases (usually air), which reduce effective ultrasonic action. Although solutions will naturally degas over time, using Degas Mode speeds up the degassing process. Solutions that have been sitting unused for 24 hours or longer have reabsorbed some gases.

Degassing 2 -degassing mode is also used where gas has to be removed from liquids or samples.

Heat - increases the chemical activity of cleaning solutions.

Solvents - never use solvents. Vapors of flammable solutions will collect under the unit, where ignition is possible from electrical components.

Surface tension - can be reduced by adding solution to the bath. Reduced surface tension will increase cavitation intensity and enhance cleaning.

Renewal - replace cleaning solutions often to increase ultrasonic cleaning activity. Solutions, as with most chemicals, will become depleted over time. Solutions can become contaminated with suspended soil particles which coat the tank bottom, inhibiting ultrasonic activity.

Application Hints

⚠ CAUTION ⚠

- Never clean novelty or inexpensive jewelry in the ultrasonic bath. The combination of heat and vibration may loosen a cement-held setting.
- Never clean gemstones such as emerald, amethyst, pearl, opal, coral, turquoise, peridot or lapis lazuli in the ultrasonic bath.

First time cleaning - first experiment with one piece, then proceed with the remainder.

Solution level - Be sure to maintain solution level within 1/2 inch (1.3 cm) of the tank's "operating level" line. Surface activity can vary with liquid level.

Load size - It is faster and more efficient to run several small loads rather than a few big loads.

Placing items - Never allow items to sit on the bottom of the tank. Always place them in a tray or beaker or suspend in the solution.

Rinsing items - After cleaning, use a clean water bath to rinse away chemicals adhering to items.

Lubricating items - When necessary, re-lubricate items immediately after cleaning.

Drying items - Air drying at room temperature works for some items. Place parts requiring faster drying time under hot air blowers or in ovens.

Please call your local distributor if you have application questions.

Cleaning Methods

There are two methods of cleaning - direct and indirect. Each has advantages and disadvantages. When in doubt, run test samples using both methods to decide which one produces the best results for you.

Direct Cleaning Method

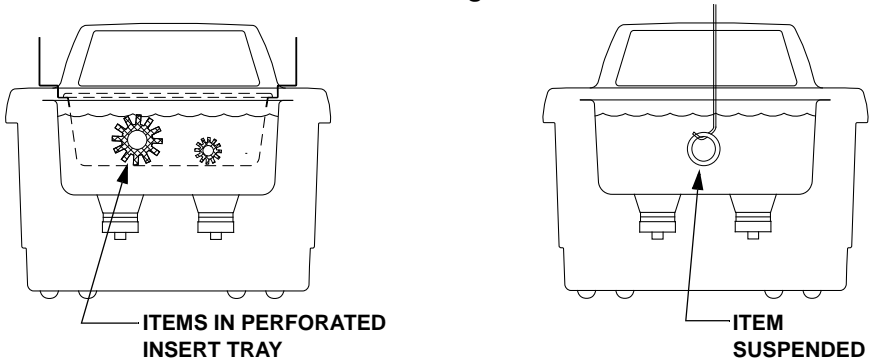

How it works:

- Fill the tank with warm water and a cleaning solution.
- Place the items to be cleaned in a perforated tray and lower them into the tank. You can also suspend items on a wire and then immerse them in the solution.

The advantages of this method are the simplicity of operation and cleaning effectiveness.

Indirect Cleaning Method

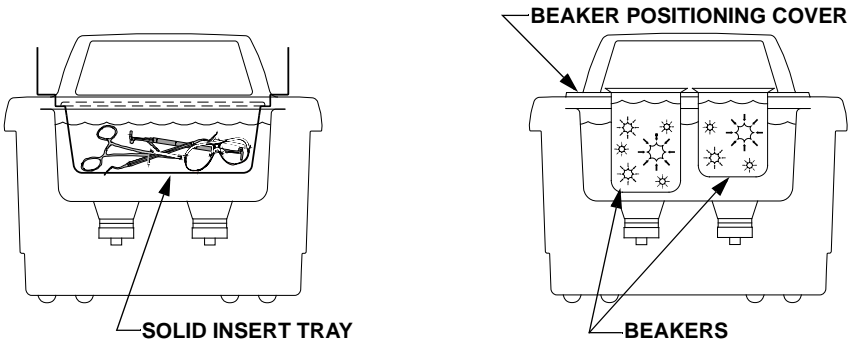

How it works:

- Fill the tank with warm water and a cleaning solution. The tank can be filled with any amount of diluted solution as long as it reaches the water level line once the items to be cleaned and accessories are placed into the tank.
- Pour your solution medium into one or more beakers or into a solid insert tray.
- Place the beakers in a beaker positioning cover or a solid insert tray to fit your unit. Beakers should not touch the tank's bottom.

The advantages of this method are:

- Removed soil stays in the beaker or tray so you can easily examine, filter or discard it.
- You can use one or more solutions at the same time.
 - two completely different cleaning solutions.
 - one beaker or tray with a cleaning solution and one with a rinse solution.
- Cleaning solution in your tank needs to be changed less often.

Non-Cleaning Application

This method can be used for sample preparation, which includes degassing liquids, mixing, homogenization, dissolving solids, cell lysing and dispersion of particles.

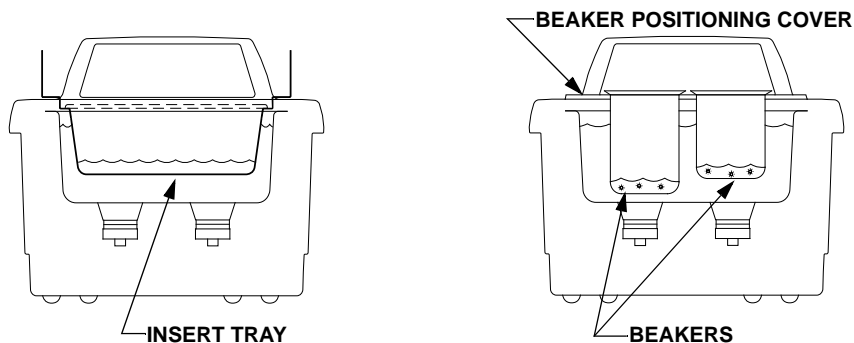

How it works:

- Fill the tank with water and wetting agent. The tray or beakers can be filled with any amount of solution as long as the water in the tank outside the tray or beakers reaches the water level line.
- Place the beakers in a beaker positioning cover, an insert basket to fit your unit, or place the beakers and flasks onto a Branson support rack. Beakers should not touch the tank's bottom.

Cleaning Solutions

CAUTION

Do not use alcohol, gasoline, bleach, mineral acids, solutions with a flash point, semi-aqueous or combustible liquids in ultrasonic tanks, or you will void the warranty. Only use non-flammable solutions and water-based solutions.

Solution Types

Water-based solutions can be either slightly acidic or alkaline. They include detergents, soaps and industrial cleaners designed to remove specific soils.

Acidic water-based solutions: remove rust, tarnish or scale. They range from mild solutions that remove tarnish, to concentrated, inhibited acidic solutions that remove investment plaster, milk-stone, zinc oxide and rust from steel and cast iron as well as smut and heat-treat scale from hardened steel.

Alkaline water-based solutions: include carbonates, silicates and caustics. These cause emulsifying action, which keeps soil from redepositing on the cleaned surface, and improves cleaning action in hard water.

Alkaline strength	Removes
Mild	Light oils and greases, cutting oils and coolant compounds.
Mild to strong	Heavy grease and oil, waxes, vegetable oils, inks, wax or fat-base buffing and polishing compounds, milk residues and carbohydrates.
Heavy-duty	Mill scale, heat-treat scale, corrosion or oxides.

Change the cleaning solution periodically. Cleaning solutions can become contaminated with suspended soil particles which coat the tank bottom. This coating dampens the ultrasonic action and reduces cleaning efficiency. Certain solutions will cavitate better than others. Contact your local distributor for further information.

Heat and cavitation increase the chemical activity of cleaning solutions. Some materials may be damaged by this stronger chemical action. When in doubt, test run samples of items to be cleaned.

Caustic solutions: used to remove rust from steels, metal alloy corrosion and a variety of tenacious soils.

Solution Amounts

Solution amounts may vary. The amount you use depends on the detergent and the type of soil to be removed. Follow instructions on the solution container and refer to the table below for the effects of solutions on metals.

Chemicals Harmful to Your Tank

The following chemicals will harm your ultrasonic tank and the action of ultrasonics and higher operating temperatures will increase their chemical activity. Do not use these or similar chemicals directly or in dilution in your ultrasonic tank or you will void your warranty.

Acetophenone	Chloroacetic Acid	Hydrocyanic Acid
Aluminum Chloride	Chloric Acid	Hydrofluoric Acid
Aluminum Fluoride	Chlorine, Anhydrous	Hydrofluosilicic Acid
Aluminum Sulphate	Chromic Acid	Iodoform
Ammonium Bifluoride	Copper Chloride	Mercuric Chloride
Ammonium Chloride	Copper Fluoborate	Muriatic Acid
Ammonium Hydroxide	Ethyl Chloride	Phosphoric (crude)
Amyl Chloride	Ferric Chloride	Sodium Hypochlorite
Antimony Trichloride	Ferrous Chloride	Potassium Chloride
Aqua Regia	Ferris Sulfate	Stannic Chloride
Bromine	Fluoboric Acid	Stannous Chloride
Calcium Bisulfate	Fluorine	Sulfur chloride
Calcium Bisulfite	Hydrobromic Acid	Sulfuric Acid
Calcium Hypochloride	Hydrochloric Acid	Zinc Chloride

Solution Effects on Metals

Cleaning Agent*	Steel	Brass	Aluminum	Magnesium	Zinc	S. Steel Copper	Tin
Optical (1)	none	none	none	none**	none**	none	none**
Jewelry (1)	none	none	none	none	none	none	none
Buffing (1) compound	none	slight stain	none	none	attacks	none	none
Oxide (2) remover	slight etch	none	slight attack	attacks	attacks	none	none
Electronic cleaner (1)	none	none	slight attack	none	none	none	none
General(1) purpose	none	none	slight attack	none	none	none	none
Industrial strength(1)	none	none	slight attack	none	none	none	none
Metal (1) cleaner 1	none	none	none	none	none	none	none
Metal (1) cleaner 2	none	none	slight attack	none	none	none	none
Metal (1) cleaner 3	none	none	none	none	none	none	none
Liquid Rust (3) stripper	none	none	attacks***	attacks***	attacks	none	slight attack
GP (1) Powder	none	none	none	none	none	none	none

*. Contact Distributor for Cleaning Agent availability outside the US.

**..No effect if solution temperature is less than 60 °C (140 °F).

(1) = Alkaline; (2) = Acidic; and (3) = Caustic.



WARNING

***** Free hydrogen may be released if solution comes in contact with reactive metals**

Troubleshooting

If your unit does not operate satisfactorily, please check the tables below for possible causes before calling your authorized service center.

⚠ WARNING ⚠
High voltage inside - dangerous shock hazard.
DO NOT attempt to disassemble or repair the unit.

Problem	Cause	What to do
Unit will not start.	Unit not plugged in properly. M/MH - Mechanical timer not ON. CPX/CPXH - POWER switch not ON. CPX/CPXH - On/Standby key malfunctioning. Blown fuse.	Plug into functioning electrical outlet. Turn timer clockwise. Press power switch ON. Call nearest authorized service center. Call nearest authorized service center.
Unit operates but does not heat solution	Heater malfunctions. MH - HEAT not ON. CPXH - HEAT not set properly. CPXH - membrane malfunctioning.	Call nearest authorized service center. Turn heat ON See "Operating your Unit" on page 33. Call nearest authorized service center.
Clogged drain	Clogged drain.	Call nearest authorized service center.
GFI protected outlet trips	Units may cause GFI circuit trips.	Connect unit to an unprotected outlet.
Unit operates but does not reach set temperature	Malfunctioning heater or sensor components.	Call nearest authorized service center.

Continued...



**High voltage inside - dangerous shock hazard.
DO NOT attempt to disassemble or repair the unit.**

Problem	Cause	What to do
Err on actual temp and alarm Icon is on. Sonics and degas operate. Auto and Heat are inactive.	Malfunctioning sensor components.	Call nearest authorized service center.
Unit operates but display does not function.	CPX/CPXH - Control board malfunctioning.	Call nearest authorized service center.
Unit stops operating and display is blank with only alarm icon on.	Overheat condition.	Turn unit off. Allow unit to cool, check solution level, then restart. Refer to page 40 for information on over temperature protection.
Decreased ultrasonic activity. NOTE: Refer to page 53 for cavitation check.	Solution is not degassed. Solution is spent. Solution level is incorrect for load. Tank bottom is covered with soil particles. Using deionized water in the tank.	Make sure that tank was filled with warm tap water plus cleaning solution and has run 5–10 minutes. Change solution. Adjust solution to within 3/8 inch (1 cm) of the tank's operating level line with load. Empty, then clean tank with warm water. Wipe with a nonabrasive cloth. Deionized water does not cavitate as actively as soapy tap water.

Glass Slide Test

Check your ultrasonic bath periodically to test the level of activity of the ultrasonic cavitation. Frequency of testing will depend on your use of the unit, however, Branson suggests running this test monthly.

You will need the following equipment:

- Frosted microscope glass slide (1" x 3"), such as Fisherbrand^{®1} #12-550-343 frosted microscope slides, or equivalent;
- No. 2 lead pencil; and
- General purpose household cleaning solution, such as Dawn^{®2} liquid soap.

Test procedure:

1. Prepare a fresh solution with general purpose household cleaning solution (concentration 1%) and warm tap water 49 °C – 60 °C (120 °F – 140 °F).
2. Fill the tank to within 3/8 inch (1 cm) of the "operating level" line.
3. Turn the ultrasonics on for at least five to ten minutes to allow for degassing.
4. Prepare the glass slide by first wetting the frosted portion with tap water.

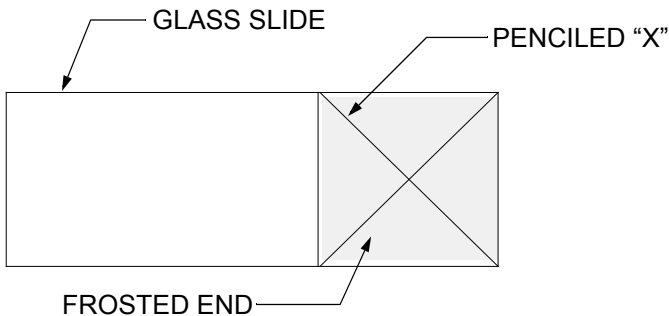

-
1. Fisherbrand is a registered trademark of Fisher Scientific Company.
 2. Dawn is a registered trademark of Procter & Gamble Company U.S.A.

5. With the No. 2 pencil, on the frosted portion make an “X” from corner to corner.
6. Immerse the frosted end of the slide into the solution. Hold the slide vertically and center it in the solution.
7. Make sure that model CPX/CPHX models are in Timed or Constant Sonics Mode, not Degass Mode, then turn ultrasonics On.

The ultrasonics will begin immediately to remove the lead from the slide. All lead should be removed within 10 seconds. If your unit passes this test, its ultrasonic cavitation is acceptable.

NOTE:

To ensure consistency from test to test, be sure to repeat test conditions—use the same solution concentration, liquid level, temperature, type of pencil, length of degassing, etc.

Service Centers

With normal use, your Ultrasonic Bath should not require servicing. However, if it fails to operate satisfactorily, first try to diagnose the problem by following the suggestions in the Troubleshooting Guide on pages 51–52.



WARNING
You will void the warranty if you disassemble your unit. High voltage inside the unit is dangerous.

If you find that your unit needs repair, carefully pack and return it to your local distributor. If under warranty, remember to include proof of purchase.

Your unit will be shipped by ground service unless you specify otherwise.

Authorized Service Centers (North America)

Name	Address	Tel/Fax Number
Alpha Omega Electronics Corp.	2821 National Drive Garland, TX 75041	Tel: 972-271-5571 Tel: 800-540-4967 Fax: 972-840-3668
Crystal Electronics Inc.	1251 Gorham St. Unit 2 Newmarket, ON Canada L3Y 8Y6	Tel: 905-953-9129 Fax: 905-953-7965
Paragon Electronics	6861 SW 196th Ave. Suite 404 Pembroke Pines, Florida 33332	Tel: 954-434-8191 Fax: 954-434-8385
Master Sonics Repair Center	77 Whiting St. Plainville, CT 06062	Tel: 860-410-1700 800-737-2198 Fax: 860-410-1704

Technical Support (North America)

Name	Address	Tel/Fax Number
Branson Ultrasonics Corp.	41 Eagle Road P.O. Box 1961 Danbury, CT 06813-1961	Tel: 203-796-0339 Tel: 203-796-2296 Tel: 800-732-9262 Fax: 203-796-2240

Authorized Service Center / Technical Support (Europe)

Name	Address	Tel/Fax Number
Branson Ultrasonics BV	Vlierberg 26A NL-3755 BS Eemnes	Tel: 31-35-60-98111 Fax: 31-35-60-98120

Authorized Service Center / Technical Support (Asia)

Name	Address	Tel/Fax Number
Branson Ultrasonics (Shanghai) Co. Ltd.	758 East Rong Le Dong Lu Song Jiang Industry Zone Shanghai, 201613 PRC, China	Tel: 86-21-3781-0588 Fax: 86-21-5774-5200
Branson Ultrasonics Asia Pacific Co. Ltd.	Flat A, 5/F Pioneer Building 213 Wai Yip Street Kwun Tong, Kowloon, Hong Kong	Tel: 852-2790-3393 Fax: 852-2790-4998
Branson Ultrasonics Div. of Emerson Electric (India) Pvt. Ltd.	Plot No A 145/6 TTC Industrial Area NIDC Kopar, Navi Mumbai-400705	Tel: 91-22-64598200/220
PT. Global Mega Indonesia	Jl. Jababeka III H Blok C 17 ET Kawasan Industri Jababeka Cikarang Bekasi 17530, Indonesia	Tel: 62-21-8983-6825, 62-21-8983-6826 Fax: 62-21-8983-6824
Branson Ultrasonics Division of Emerson Japan Ltd.	4-3-14 Okada, Atsugi-Shi Kanagawa 243-0021, Japan	Tel: 81-46-229-0429 Fax: 81-46-229-0262
Branson Korea Co. Ltd.	DangJeong-dong, 506-7, Gunpo-si, Gyeonggi-do, Republic of Korea	Tel: 82-1577-0631 Fax: 82-31-422-9572
Branson Ultrasonics Div. of Emerson Elec (M) Sdn Bhd.	No. 20, Jalan Rajawali 3, Puchong Jaya Industrial Park Batu 8, Jalan Puchong, 47170 Puchong, Selangor, Malaysia	Tel: 603-8076-8608 Fax: 603-8076-8302

Name	Address	Tel/Fax Number
Branson Ultrasonics (Philippines Rep Office)	Emerson Building, 104 Laguna Blvd. Laguna Technopark Inc. Sta. Rosa, Laguna Philippines, 4026	Tel: 63-49-502-8863 Fax: 63-49-502-8860
Branson Ultrasonics Div. of Emerson Electric (South Asia) Pte. Ltd.	10 Pandan Crescent No. 03-06 UE Tech Park Singapore 128466	Tel: 65-6891-7600 Fax: 65-6873-7882
Branson Ultrasonics (Taiwan) Division of Emerson Electric Taiwan Co. Ltd.	5F-3, No. 1, Wu-Chiuan First Road Wu-Ku Ind Zone, Hsin- Chuang City Taipei County, Taiwan, 24892	Tel: 886-2-2298-0828 Fax: 886-2-2298-9985
Emerson Electric (Thailand) Co. Ltd.	662/39-40 Rama 3 Rd. Bangpongpan, Yannawa Bangkok, Thailand 10120	Tel: 662-293-0121-7 Fax: 662-293-0129

Information for Users on Disposal of Equipment



This symbol indicates separate collection of waste electrical and electronic equipment in the EU-countries and EEA (European Economic Area)

Please do not dispose the product with the general household waste. Please use the return and collection system in your country for the disposal of this product.